

Notice

Hewlett-Packard to Agilent Technologies Transition

This documentation supports a product that previously shipped under the Hewlett-Packard company brand name. The brand name has now been changed to Agilent Technologies. The two products are functionally identical, only our name has changed. The document still includes references to Hewlett-Packard products, some of which have been transitioned to Agilent Technologies.

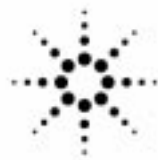

Agilent Technologies

User's Guide

HP 8753D Network Analyzer



HP Part No. 08753-90257 Supersedes October 1997
Printed in USA December 1997

Notice.

The information contained in this document is subject to change without notice.

Hewlett-Packard makes no warranty of any kind with regard to this material, including but not limited to, the implied warranties of merchantability and fitness for a particular purpose. Hewlett-Packard shall not be liable for errors contained herein or for incidental or consequential damages in connection with the furnishing, performance, or use of this material.

© Copyright Hewlett-Packard Company 1994, 1995, 1997
All Rights Reserved. Reproduction, adaptation, or translation without prior written permission is prohibited, except as allowed under the copyright laws.

1400 Fountaingrove Parkway, Santa Rosa, CA 95403-1799, USA

Certification

Hewlett-Packard Company certifies that this product met its published specifications at the time of shipment from the factory. Hewlett-Packard further certifies that its calibration measurements are traceable to the United States National Institute of Standards and Technology, to the extent allowed by the Institute's calibration facility, and to the calibration facilities of other International Standards Organization members.

Warranty

This Hewlett-Packard instrument product is warranted against defects in material and workmanship for a period of one year from date of shipment. During the warranty period, Hewlett-Packard Company will, at its option, either repair or replace products which prove to be defective.

For warranty service or repair, this product must be returned to a service facility designated by Hewlett-Packard. Buyer shall prepay shipping charges to Hewlett-Packard and Hewlett-Packard shall pay shipping charges to return the product to Buyer. However, Buyer shall pay all shipping charges, duties, and taxes for products returned to Hewlett-Packard from another country.

Hewlett-Packard warrants that its software and firmware designated by Hewlett-Packard for use with an instrument will execute its programming instructions when properly installed on that instrument. Hewlett-Packard does not warrant that the operation of the instrument, or software, or firmware will be uninterrupted or error-free.

LIMITATION OF WARRANTY

The foregoing warranty shall not apply to defects resulting from improper or inadequate maintenance by Buyer, Buyer-supplied software or interfacing, unauthorized modification or misuse, operation outside of the environmental specifications for the product, or improper site preparation or maintenance.

NO OTHER WARRANTY IS EXPRESSED OR IMPLIED. HEWLETT-PACKARD SPECIFICALLY DISCLAIMS THE IMPLIED WARRANTIES OF MERCHANTABILITY AND FITNESS FOR A PARTICULAR PURPOSE.

EXCLUSIVE REMEDIES

THE REMEDIES PROVIDED HEREIN ARE BUYER'S SOLE AND EXCLUSIVE REMEDIES. HEWLETT-PACKARD SHALL NOT BE LIABLE FOR ANY DIRECT, INDIRECT, SPECIAL, INCIDENTAL, OR CONSEQUENTIAL DAMAGES, WHETHER BASED ON CONTRACT, TORT, OR ANY OTHER LEGAL THEORY.

Maintenance

Clean the cabinet, using a damp cloth only.

Assistance

Product maintenance agreements and other customer assistance agreements are available for Hewlett-Packard products.

For any assistance, contact your nearest Hewlett-Packard Sales and Service Office.

By internet, phone, or fax, get assistance with all your test and measurement needs.

Table 1-1 Contacting Agilent

Online assistance: www.agilent.com/find/assist

United States
(tel) 1 800 452 4844

Latin America
(tel) (305) 269 7500
(fax) (305) 269 7599

Canada
(tel) 1 877 894 4414
(fax) (905) 282-6495

Europe
(tel) (+31) 20 547 2323
(fax) (+31) 20 547 2390

New Zealand
(tel) 0 800 738 378
(fax) (+64) 4 495 8950

Japan
(tel) (+81) 426 56 7832
(fax) (+81) 426 56 7840

Australia
(tel) 1 800 629 485
(fax) (+61) 3 9210 5947

Asia Call Center Numbers

Country	Phone Number	Fax Number
Singapore	1-800-375-8100	(65) 836-0252
Malaysia	1-800-828-848	1-800-801664
Philippines	(632) 8426802 1-800-16510170 (PLDT Subscriber Only)	(632) 8426809 1-800-16510288 (PLDT Subscriber Only)
Thailand	(088) 226-008 (outside Bangkok) (662) 661-3999 (within Bangkok)	(66) 1-661-3714
Hong Kong	800-930-871	(852) 2506 9233
Taiwan	0800-047-866	(886) 2 25456723
People's Republic of China	800-810-0189 (preferred) 10800-650-0021	10800-650-0121
India	1-600-11-2929	000-800-650-1101

Safety Symbols

The following safety symbols are used throughout this manual. Familiarize yourself with each of the symbols and its meaning before operating this instrument.

Caution Caution denotes a hazard. It calls attention to a procedure that, if not correctly performed or adhered to, would result in damage to or destruction of the instrument. Do not proceed beyond a caution note until the indicated conditions are fully understood and met.

Warning Warning denotes a hazard. It calls attention to a procedure which, if not correctly performed or adhered to, could result in injury or loss of life. Do not proceed beyond a warning note until the indicated conditions are fully understood and met.

Instrument Markings



The instruction documentation symbol. The product is marked with this symbol when it is necessary for the user to refer to the instructions in the documentation.

“CE” The CE mark is a registered trademark of the European Community. (If accompanied by a year, it is when the design was proven.)

“ISM1-A” This is a symbol of an Industrial Scientific and Medical Group 1 Class A product.

“CSA” The CSA mark is a registered trademark of the Canadian Standards Association.

General Safety Considerations

Warning This is a Safety Class I product (provided with a protective earthing ground incorporated in the power cord). The mains plug shall only be inserted in a socket outlet provided with a protective earth contact. Any interruption of the protective conductor, inside or outside the instrument, is likely to make the instrument dangerous. Intentional interruption is prohibited.

Warning No operator serviceable parts inside. Refer servicing to qualified personnel. To prevent electrical shock, do not remove covers.

Caution Before switching on this instrument, make sure that the line voltage selector switch is set to the voltage of the power supply and the correct fuse is installed.

Warning The opening of covers or removal of parts is likely to expose dangerous voltages. Disconnect the instrument from all voltage sources while it is being opened.

Warning The power cord is connected to internal capacitors that may remain live for 10 seconds after disconnecting the plug from its power supply.

Warning For continued protection against fire hazard replace line fuse only with same type and rating (F 3A/250V). The use of other fuses or material is prohibited.

Warning If this instrument is used in a manner not specified by Hewlett-Packard Co., the protection provided by the instrument may be impaired.

Note This instrument has been designed and tested in accordance with IEC Publication 348, Safety Requirements for Electronics Measuring Apparatus, and has been supplied in a safe condition. This instruction documentation contains information and warnings which must be followed by the user to ensure safe operation and to maintain the instrument in a safe condition.

User's Guide Overview

- Chapter 1, “HP 8753D Description and Options,” describes features, functions, and available options.
- Chapter 2, “Making Measurements,” contains step-by-step procedures for making measurements or using particular functions.
- Chapter 3, “Making Mixer Measurements,” contains step-by-step procedures for making calibrated and error-corrected mixer measurements.
- Chapter 4, “Printing, Plotting, and Saving Measurement Results,” contains instructions for saving to disk or the analyzer internal memory, and printing and plotting displayed measurements.
- Chapter 5, “Optimizing Measurement Results,” describes techniques and functions for achieving the best measurement results.
- Chapter 6, “Application and Operation Concepts,” contains explanatory-style information about many applications and analyzer operation.
- Chapter 7, “Specifications and Measurement Uncertainties,” defines the performance capabilities of the analyzer.
- Chapter 8, “Menu Maps,” shows softkey menu relationships.
- Chapter 9, “Key Definitions,” describes all the front panel keys, softkeys, and their corresponding HP-IB commands.
- Chapter 10, “Error Messages,” provides information for interpreting error messages.
- Chapter 11, “Compatible Peripherals,” lists measurement and system accessories, and other applicable equipment compatible with the analyzer. Procedures for configuring the peripherals, and an HP-IB programming overview are also included.
- Chapter 12, “Preset State and Memory Allocation,” contains a discussion of memory allocation, memory storage, instrument state definitions, and preset conditions.
- Appendix A, “The CITIfile Data Format and Key Word Reference,” contains information on the CITIfile data format as well as a list of CITIfile keywords.

Network Analyzer Documentation Set

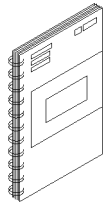

The **Installation and Quick Start Guide** familiarizes you with the network analyzer's front and rear panels, electrical and environmental operating requirements, as well as procedures for installing, configuring, and verifying the operation of the analyzer.

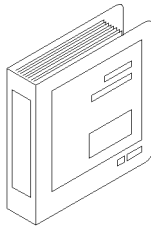

The **User's Guide** shows how to make measurements, explains commonly-used features, and tells you how to get the most performance from your analyzer.

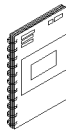

The **Quick Reference Guide** provides a summary of selected user features.

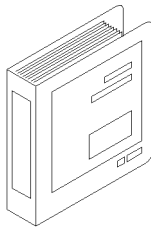

The **Programmer's Guide** provides programming information including an HP-IB programming and command reference as well as programming examples.

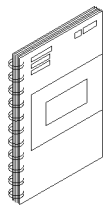

The **System Verification and Test Guide** provides the system verification and performance tests and the Performance Test Record for your analyzer.

DECLARATION OF CONFORMITY

according to ISO/IEC Guide 22 and EN 45014

Manufacturer's Name: Hewlett-Packard Co.

Manufacturer's Address: Microwave Instruments Division
1400 Fountaingrove Parkway
Santa Rosa, CA 95403-1799
USA

declares that the product

Product Name: Network Analyzer

Model Number: HP 8753D

Product Options: This declaration covers all options of the above product.

conforms to the following Product specifications:

Safety: IEC 348:1978/HD 401 S1:1981
CAN/CSA-C22.2 No. 231 (Series M-89)

EMC: CISPR 11:1990/EN 55011:1991 Group 1, Class A
IEC 801-2:1984/EN 50082-1:1992 4 kV CD, 8 kV AD
IEC 801-3:1984/EN 50082-1:1992 3 V/m, 27-500 MHz
IEC 801-4:1988/EN 50082-1:1992 0.5 kV Sig. Lines, 1 kV Power Lines

IEC 555-2:1982 +A1:1985 / EN 60555-2:1987
IEC 555-3:1982 + A1:1990 / EN 60555-3:1987 + A1:1991

Supplementary Information:

The product herewith complies with the requirements of the Low Voltage Directive 73/23/EEC and the EMC Directive 89/336/EEC and carries the CE-marking accordingly.

Safety qualification tests for this product was performed prior to 1 December 1993.

Santa Rosa, California, USA 20 Dec. 1996

John Hiatt/Quality Engineering Manager

European Contact: Your local Hewlett-Packard Sales and Service Office or Hewlett-Packard GmbH, Department HQ-TRE, Herrenberger Strasse 130, D-71034 Böblingen, Germany (FAX +49-7031-14-3143)

Contents

1. HP 8753D Description and Options

Where to Look for More Information	1-1
Analyzer Description	1-2
Front Panel Features	1-4
Analyzer Display	1-6
Rear Panel Features and Connectors	1-10
Analyzer Options Available	1-12
Option 1D5, High Stability Frequency Reference	1-12
Option 002, Harmonic Mode	1-12
Option 006, 6 GHz Operation	1-12
Option 010, Time Domain	1-12
Option 011, Receiver Configuration	1-12
Option 075, 75 Ω Impedance	1-12
Option 1CM, Rack Mount Flange Kit Without Handles	1-12
Option 1CP, Rack Mount Flange Kit With Handles	1-12
Service and Support Options	1-13
On-Site System Verification (+23G)	1-13
Standard System Maintenance Service (+02A)	1-13
Basic System Maintenance Service (+02B)	1-13
Return to HP Full Service Agreement (+22A)	1-13
Return to HP Repair Agreement (+22B)	1-13
Return to HP Calibration Agreement (+22C)	1-13
Return to HP Calibration (+22G)	1-13
Changes between the HP 8753 Network Analyzers	1-14

2. Making Measurements

Where to Look for More Information	2-1
Principles of Microwave Connector Care	2-2
Basic Measurement Sequence and Example	2-3
Basic Measurement Sequence	2-3
Basic Measurement Example	2-3
Step 1. Connect the device under test and any required test equipment.	2-3
Step 2. Choose the measurement parameters.	2-3
Setting the Frequency Range	2-3
Setting the Source Power	2-4
Setting the Measurement	2-4
Step 3. Perform and apply the appropriate error-correction.	2-4
Step 4. Measure the device under test.	2-4
Step 5. Output the measurement results.	2-4
Using the Display Functions	2-5
To View Both Measurement Channels	2-5
To Save a Data Trace to the Display Memory	2-6
To View the Measurement Data and Memory Trace	2-6
To Divide Measurement Data by the Memory Trace	2-7
To Subtract the Memory Trace from the Measurement Data Trace	2-7
To Ratio Measurements in Channel 1 and 2	2-7

To Title the Active Channel Display	2-8
Using Analyzer Display Markers	2-9
To Use Continuous and Discrete Markers	2-9
To Activate Display Markers	2-10
To Use Delta (Δ) Markers	2-11
To Activate a Fixed Marker	2-11
Using the ΔREF=ΔFIXED MKR Key to activate a Fixed Reference Marker	2-12
Using the MKR ZERO Key to Activate a Fixed Reference Marker	2-13
To Couple and Uncouple Display Markers	2-14
To Use Polar Format Markers	2-14
To Use Smith Chart Markers	2-15
To Set Measurement Parameters Using Markers	2-16
Setting the Start Frequency	2-17
Setting the Stop Frequency	2-17
Setting the Center Frequency	2-18
Setting the Frequency Span	2-19
Setting the Display Reference Value	2-20
Setting the Electrical Delay	2-21
Setting the CW Frequency	2-21
To Search for a Specific Amplitude	2-22
Searching for the Maximum Amplitude	2-22
Searching for the Minimum Amplitude	2-23
Searching for a Target Amplitude	2-24
Searching for a Bandwidth	2-25
Tracking the Amplitude that You are Searching	2-25
To Calculate the Statistics of the Measurement Data	2-26
Measuring Magnitude and Insertion Phase Response	2-27
Measuring the Magnitude Response	2-27
Measuring Insertion Phase Response	2-28
Measuring Electrical Length and Phase Distortion	2-30
Measuring Electrical Length	2-30
Measuring Phase Distortion	2-32
Deviation From Linear Phase	2-32
Group Delay	2-33
Testing A Device with Limit Lines	2-36
Setting Up the Measurement Parameters	2-36
Creating Flat Limit Lines	2-37
Creating a Sloping Limit Line	2-39
Creating Single Point Limits	2-41
Editing Limit Segments	2-42
Deleting Limit Segments	2-42
Running a Limit Test	2-43
Reviewing the Limit Line Segments	2-43
Activating the Limit Test	2-43
Offsetting Limit Lines	2-44
Measuring Gain Compression	2-45
Measuring Gain and Reverse Isolation Simultaneously	2-49
Measurements Using the Tuned Receiver Mode	2-51
Typical test setup	2-51
Tuned receiver mode in-depth description	2-51
Frequency Range	2-51
Compatible Sweep Types	2-51
External Source Requirements	2-52
Test Sequencing	2-53

Creating a Sequence	2-54
Running a Sequence	2-55
Stopping a Sequence	2-55
Editing a Sequence	2-56
Deleting Commands	2-56
Inserting a Command	2-56
Modifying a Command	2-57
Clearing a Sequence from Memory	2-57
Changing the Sequence Title	2-58
Naming Files Generated by a Sequence	2-58
Storing a Sequence on a Disk	2-59
Loading a Sequence from Disk	2-60
Purging a Sequence from Disk	2-60
Printing a Sequence	2-60
Cascading Multiple Example Sequences	2-61
Loop Counter Example Sequence	2-62
Generating Files in a Loop Counter Example Sequence	2-63
Limit Test Example Sequence	2-64
Measuring Swept Harmonics	2-66
Measuring a Device in the Time Domain (Option 010 Only)	2-68
Transmission Response in Time Domain	2-68
Reflection Response in Time Domain	2-73
Non-coaxial Measurements	2-76

3. Making Mixer Measurements

Where to Look for More Information	3-1
Measurement Considerations	3-2
Minimizing Source and Load Mismatches	3-2
Reducing the Effect of Spurious Responses	3-2
Eliminating Unwanted Mixing and Leakage Signals	3-2
How RF and IF Are Defined	3-2
Frequency Offset Mode Operation	3-4
Differences Between Internal and External R-Channel Inputs	3-4
Power Meter Calibration	3-6
Conversion Loss Using the Frequency Offset Mode	3-7
High Dynamic Range Swept RF/IF Conversion Loss	3-12
Fixed IF Mixer Measurements	3-17
Tuned Receiver Mode	3-17
Sequence 1 Setup	3-17
Sequence 2 Setup	3-21
Phase or Group Delay Measurements	3-24
Amplitude and Phase Tracking	3-27
Conversion Compression Using the Frequency Offset Mode	3-28
Isolation Example Measurements	3-33
LO to RF Isolation	3-33
RF Feedthrough	3-35

4. Printing, Plotting, and Saving Measurement Results	
Where to Look for More Information	4-2
Printing or Plotting Your Measurement Results	4-3
Configuring a Print Function	4-3
Defining a Print Function	4-5
If You are Using a Color Printer	4-6
To Reset the Printing Parameters to Default Values	4-6
Printing One Measurement Per Page	4-6
Printing Multiple Measurements Per Page	4-7
Configuring a Plot Function	4-8
If You are Plotting to an HPGL/2 Compatible Printer	4-8
If You are Plotting to a Pen Plotter	4-10
If You are Plotting to a Disk Drive	4-11
Defining a Plot Function	4-12
Choosing Display Elements	4-12
Selecting Auto-Feed	4-12
Selecting Pen Numbers and Colors	4-13
Selecting Line Types	4-14
Choosing Scale	4-15
Choosing Plot Speed	4-15
To Reset the Plotting Parameters to Default Values	4-16
Plotting One Measurement Per Page Using a Pen Plotter	4-16
Plotting Multiple Measurements Per Page Using a Pen Plotter	4-17
If You are Plotting to an HPGL Compatible Printer	4-18
Plotting a Measurement to Disk	4-19
To Output the Plot Files	4-20
To View Plot Files on a PC	4-20
Using AmiPro	4-21
Using Freelance	4-22
Outputting Plot Files from a PC to a Plotter	4-22
Outputting Plot Files from a PC to an HPGL Compatible Printer	4-23
Step 1. Store the HPGL initialization sequence.	4-23
Step 2. Store the exit HPGL mode and form feed sequence.	4-24
Step 3. Send the HPGL initialization sequence to the printer.	4-24
Step 4. Send the plot file to the printer.	4-24
Step 5. Send the exit HPGL mode and form feed sequence to the printer.	4-24
Outputting Single Page Plots Using a Printer	4-24
Outputting Multiple Plots to a Single Page Using a Printer	4-25
Plotting Multiple Measurements Per Page From Disk	4-26
To Plot Multiple Measurements on a Full Page	4-26
To Plot Measurements in Page Quadrants	4-28
Titling the Displayed Measurement	4-29
Configuring the Analyzer to Produce a Time Stamp	4-30
Aborting a Print or Plot Process	4-30
Printing or Plotting the List Values or Operating Parameters	4-30
If You want a Single Page of Values	4-30
If You Want the Entire List of Values	4-31
Solving Problems with Printing or Plotting	4-32
Saving and Recalling Instrument States	4-33
Places Where You Can Save	4-33
What You Can Save to the Analyzer's Internal Memory	4-33
What You Can Save to a Floppy Disk	4-33
What You Can Save to a Computer	4-34
Saving an Instrument State	4-35
Saving Measurement Results	4-36

ASCII Data Formats	4-39
CITIfile	4-39
S2P Data Format	4-39
Re-Saving an Instrument State	4-41
Deleting a File	4-41
To Delete an Instrument State File	4-41
To Delete all Files	4-41
Renaming a File	4-42
Recalling a File	4-42
Formatting a Disk	4-43
Solving Problems with Saving or Recalling Files	4-43
If You are Using an External Disk Drive	4-43

5. Optimizing Measurement Results

Where to Look for More Information	5-2
Increasing Measurement Accuracy	5-2
Connector Repeatability	5-2
Interconnecting Cables	5-2
Temperature Drift	5-2
Frequency Drift	5-3
Performance Verification	5-3
Reference Plane and Port Extensions	5-3
Measurement Error-Correction	5-4
Conditions Where Error-Correction is Suggested	5-4
Types of Error-Correction	5-4
Error-Correction Stimulus State	5-5
Calibration Standards	5-6
Compensating for the Electrical Delay of Calibration Standards	5-6
Clarifying Type-N Connector Sex	5-6
When to Use Interpolated Error-Correction	5-6
Procedures for Error-Correcting Your Measurements	5-7
Frequency Response Error-Corrections	5-8
Response Error-Correction for Reflection Measurements	5-8
Response Error-Correction for Transmission Measurements	5-10
Receiver Calibration	5-11
Frequency Response and Isolation Error-Corrections	5-13
Response and Isolation Error-Correction for Reflection Measurements	5-13
Response and Isolation Error-Correction for Transmission Measurements	5-15
One-Port Reflection Error-Correction	5-17
Full Two-Port Error-Correction	5-20
TRL* and TRM* Error-Correction	5-23
TRL Error-Correction	5-23
TRM Error-Correction	5-24
Modifying Calibration Kit Standards	5-26
Definitions	5-26
Outline of Standard Modification	5-26
Modifying Standards	5-26
Modifying TRL Standards	5-28
Modifying TRM Standards	5-30
Power Meter Measurement Calibration	5-33
Entering the Power Sensor Calibration Data	5-34
Editing Frequency Segments	5-34
Deleting Frequency Segments	5-35
Compensating for Directional Coupler Response	5-35
Using Sample-and-Sweep Correction Mode	5-36

Using Continuous Correction Mode	5-37
To Calibrate the Analyzer Receiver to Measure Absolute Power	5-38
Matched Adapters	5-39
Modify the Cal Kit Thru Definition	5-40
Calibrating for Noninsertable Devices	5-41
Adapter Removal	5-42
Perform the 2-port Error Corrections	5-43
Remove the Adapter	5-44
Verify the Results	5-45
Example Program	5-47
Making Accurate Measurements of Electrically Long Devices	5-48
The Cause of Measurement Problems	5-48
To Improve Measurement Results	5-48
Decreasing the Sweep Rate	5-48
Decreasing the Time Delay	5-49
Increasing Sweep Speed	5-50
To Decrease the Frequency Span	5-50
To Set the Auto Sweep Time Mode	5-51
To Widen the System Bandwidth	5-52
To Reduce the Averaging Factor	5-52
To Reduce the Number of Measurement Points	5-52
To Set the Sweep Type	5-53
To View a Single Measurement Channel	5-53
To Activate Chop Sweep Mode	5-54
To Use External Calibration	5-54
To Use Fast 2-Port Calibration	5-54
Increasing Dynamic Range	5-56
To Increase the Test Port Input Power	5-56
To Reduce the Receiver Noise Floor	5-56
Changing System Bandwidth	5-56
Changing Measurement Averaging	5-56
Reducing Trace Noise	5-57
To Activate Averaging	5-57
To Change System Bandwidth	5-57
Reducing Receiver Crosstalk	5-57
Reducing Recall Time	5-58
Understanding Spur Avoidance	5-59

6. Application and Operation Concepts

Where to Look for More Information	6-1
HP 8753D System Operation	6-2
The Built-In Synthesized Source	6-2
The Source Step Attenuator	6-2
The Built-In Test Set	6-3
The Receiver Block	6-3
The Microprocessor	6-3
Required Peripheral Equipment	6-3
Data Processing	6-4
Processing Details	6-5
The ADC	6-5
IF Detection	6-5
Ratio Calculations	6-5
Sampler/IF Correction	6-5
Sweep-To-Sweep Averaging	6-5
Pre-Raw Data Arrays	6-6

Raw Arrays	6-6
Vector Error-correction (Accuracy Enhancement)	6-6
Trace Math Operation	6-6
Gating (Option 010 Only)	6-6
The Electrical Delay Block	6-6
Conversion	6-6
Transform (Option 010 Only)	6-6
Format	6-7
Smoothing	6-7
Format Arrays	6-7
Offset and Scale	6-7
Display Memory	6-7
Active Channel Keys	6-8
Dual Channel	6-8
Uncoupling Stimulus Values Between Channels	6-8
Coupled Markers	6-8
Entry Block Keys	6-9
Units Terminator	6-9
Knob	6-10
Step Keys	6-10
<input type="button" value="ENTRY OFF"/>	6-10
<input type="button" value="←"/>	6-10
<input type="button" value="."/>	6-10
<input type="button" value="−"/>	6-10
Stimulus Functions	6-11
Defining Ranges with Stimulus Keys	6-11
Stimulus Menu	6-12
The Power Menu	6-13
Understanding the Power Ranges	6-13
Automatic mode	6-13
Manual mode	6-13
Power Coupling Options	6-15
Channel coupling	6-15
Test port coupling	6-15
Sweep Time	6-16
Manual Sweep Time Mode	6-16
Auto Sweep Time Mode	6-16
Minimum Sweep Time	6-16
Trigger Menu	6-18
Source Attenuator Switch Protection	6-19
Allowing Repetitive Switching of the Attenuator	6-19
Channel Stimulus Coupling	6-20
Sweep Type Menu	6-21
Linear Frequency Sweep (Hz)	6-21
Logarithmic Frequency Sweep (Hz)	6-22
List Frequency Sweep (Hz)	6-22
Segment Menu	6-22
Power Sweep (dBm)	6-23
CW Time Sweep (Seconds)	6-23
Selecting Sweep Modes	6-23
Modifying List Frequencies	6-23
Edit list menu	6-23
Edit subsweep menu	6-24
Response Functions	6-25
S-Parameters	6-26

Understanding S-Parameters	6-26
The S-Parameter Menu	6-27
Analog In Menu	6-27
Conversion Menu	6-27
Input Ports Menu	6-28
The Format Menu	6-29
Log Magnitude Format	6-29
Phase Format	6-30
Group Delay Format	6-30
Smith Chart Format	6-31
Polar Format	6-32
Linear Magnitude Format	6-33
SWR Format	6-33
Real Format	6-34
Imaginary Format	6-34
Group Delay Principles	6-35
Scale Reference Menu	6-38
Electrical Delay	6-38
Display Menu	6-39
Dual Channel Mode	6-40
Dual Channel Mode with Decoupled Channel Power	6-40
Memory Math Functions	6-41
Adjusting the Colors of the Display	6-41
Setting Display Intensity	6-41
Setting Default Colors	6-42
Blanking the Display	6-42
Saving Modified Colors	6-42
Recalling Modified Colors	6-42
The Modify Colors Menu	6-42
Averaging Menu	6-44
Averaging	6-44
Smoothing	6-45
IF Bandwidth Reduction	6-45
Markers	6-47
Marker Menu	6-48
Delta Mode Menu	6-48
Fixed Marker Menu	6-48
Marker Function Menu	6-49
Marker Search Menu	6-49
Target Menu	6-49
Marker Mode Menu	6-49
Polar Marker Menu	6-49
Smith Marker Menu	6-49
Measurement Calibration	6-50
What is Accuracy Enhancement?	6-50
What Causes Measurement Errors?	6-51
Directivity	6-51
Source Match	6-52
Load Match	6-52
Isolation (Crosstalk)	6-53
Frequency Response (Tracking)	6-53
Characterizing Microwave Systematic Errors	6-53
One-Port Error Model	6-53
Device Measurement	6-59
Two-Port Error Model	6-59

Calibration Considerations	6-65
Measurement Parameters	6-65
Device Measurements	6-65
Omitting Isolation Calibration	6-65
Saving Calibration Data	6-65
The Calibration Standards	6-66
Frequency Response of Calibration Standards	6-66
Electrical Offset	6-67
Fringe Capacitance	6-67
How Effective Is Accuracy Enhancement?	6-69
Correcting for Measurement Errors	6-71
Ensuring a Valid Calibration	6-71
Interpolated Error-correction	6-72
The Calibrate Menu	6-73
Response Calibration	6-73
Response and Isolation Calibration	6-73
S_{11} and S_{22} One-Port Calibration	6-73
Full Two-Port Calibration	6-73
TRL*/LRM* Two-Port Calibration	6-74
Restarting a Calibration	6-75
Cal Kit Menu	6-75
The Select Cal Kit Menu	6-75
Modifying Calibration Kits	6-76
Definitions	6-76
Procedure	6-76
Modify Calibration Kit Menu	6-77
Define Standard Menus	6-78
Specify Offset Menu	6-80
Label Standard Menu	6-81
Specify Class Menu	6-81
Label Class Menu	6-83
Label Kit Menu	6-83
Verify performance	6-84
TRL*/LRM* Calibration	6-85
Why Use TRL Calibration?	6-85
TRL Terminology	6-85
How TRL*/LRM* Calibration Works	6-86
TRL* Error Model	6-86
Isolation	6-87
Source match and load match	6-88
Improving Raw Source Match and Load Match For TRL*/LRM* Calibration	6-88
The TRL Calibration Procedure	6-90
Requirements for TRL Standards	6-90
Fabricating and defining calibration standards for TRL/LRM	6-91
TRL Options	6-93
Power Meter Calibration	6-95
Primary Applications	6-95
Calibrated Power Level	6-95
Compatible Sweep Types	6-95
Loss of Power Meter Calibration Data	6-96
Interpolation in Power Meter Calibration	6-96
Power Meter Calibration Modes of Operation	6-96
Continuous Sample Mode (Each Sweep)	6-96
Sample-and-Sweep Mode (One Sweep)	6-97
Power Loss Correction List	6-98

Power Sensor Calibration Factor List	6-98
Speed and Accuracy	6-98
Test Equipment Used	6-98
Stimulus Parameters	6-98
Notes On Accuracy	6-99
Alternate and Chop Sweep Modes	6-100
Alternate	6-100
Chop	6-100
Calibrating for Non-Insertable Devices	6-101
Adapter Removal	6-101
Matched Adapters	6-101
Modify the Cal Kit Thru Definition	6-101
Using the Instrument State Functions	6-102
HP-IB Menu	6-103
LOCAL Key	6-103
HP-IB STATUS Indicators	6-104
System Controller Mode	6-104
Talker/Listener Mode	6-104
Pass Control Mode	6-104
Address Menu	6-104
Using the Parallel Port	6-105
The Copy Mode	6-105
The GPIO Mode	6-105
The System Menu	6-106
The Limits Menu	6-106
Edit Limits Menu	6-107
Edit Segment Menu	6-107
Offset Limits Menu	6-108
Knowing the Instrument Modes	6-109
Network Analyzer Mode	6-109
External Source Mode	6-109
Primary Applications	6-109
Typical Test Setup	6-110
External Source Mode In-Depth Description	6-110
External Source Auto	6-110
External Source Manual	6-110
CW Frequency Range in External Source Mode	6-111
Compatible Sweep Types	6-111
External Source Requirements	6-111
Capture Range	6-111
Locking onto a signal with a frequency modulation component	6-111
Tuned Receiver Mode	6-111
Frequency Offset Menu	6-112
Primary Applications	6-112
Typical Test Setup	6-112
Frequency Offset In-Depth Description	6-113
The Receiver Frequency	6-113
The Offset Frequency (LO)	6-113
Frequency Hierarchy	6-113
Frequency Ranges	6-113
Compatible Instrument Modes and Sweep Types	6-113
Receiver and Source Requirements	6-114
Display Annotations	6-114
Error Message	6-114
Spurious Signal Passband Frequencies	6-114

Harmonic Operation (Option 002 only)	6-115
Typical Test Setup	6-115
Single-Channel Operation	6-115
Dual-Channel Operation	6-115
Coupling Power Between Channels 1 and 2	6-115
Frequency Range	6-116
Accuracy and input power	6-116
Time Domain Operation (Option 010)	6-117
The Transform Menu	6-117
General Theory	6-118
Time Domain Bandpass	6-119
Adjusting the Relative Velocity Factor	6-119
Reflection Measurements Using Bandpass Mode	6-119
Interpreting the bandpass reflection response horizontal axis	6-120
Interpreting the bandpass reflection response vertical axis	6-120
Transmission Measurements Using Bandpass Mode	6-121
Interpreting the bandpass transmission response horizontal axis	6-121
Interpreting the bandpass transmission response vertical axis	6-121
Time domain low pass	6-122
Setting frequency range for time domain low pass	6-122
Minimum allowable stop frequencies	6-123
Reflection Measurements In Time Domain Low Pass	6-123
Interpreting the low pass response horizontal axis	6-123
Interpreting the low pass response vertical axis	6-123
Fault Location Measurements Using Low Pass	6-123
Transmission Measurements In Time Domain Low Pass	6-125
Measuring small signal transient response using low pass step	6-125
Interpreting the low pass step transmission response horizontal axis	6-126
Interpreting the low pass step transmission response vertical axis	6-126
Measuring separate transmission paths through the test device using low pass impulse mode	6-126
Time Domain Concepts	6-127
Masking	6-127
Windowing	6-128
Range	6-130
Resolution	6-131
Response resolution	6-131
Range resolution	6-132
Gating	6-133
Setting the gate	6-133
Selecting gate shape	6-134
Transforming CW Time Measurements Into the Frequency Domain	6-134
Forward Transform Measurements	6-135
Interpreting the forward transform vertical axis	6-135
Interpreting the forward transform horizontal axis	6-135
Demodulating the results of the forward transform	6-135
Forward transform range	6-136
Test Sequencing	6-138
In-Depth Sequencing Information	6-138
Features That Operate Differently When Executed In a Sequence	6-138
Commands That Sequencing Completes Before the Next Sequence Command Begins	6-138
Commands That Require a Clean Sweep	6-139
Forward Stepping In Edit Mode	6-139
Titles	6-139

Sequence Size	6-139
Embedding the Value of the Loop Counter In a Title	6-139
Autostarting Sequences	6-139
The GPIO Mode	6-139
The Sequencing Menu	6-140
Gosub Sequence Command	6-140
TTL I/O Menu	6-140
TTL Output for Controlling Peripherals	6-140
TTL Input Decision Making	6-140
TTL Out Menu	6-142
Sequencing Special Functions Menu	6-142
Sequence Decision Making Menu	6-142
Decision Making Functions	6-142
Decision making functions jump to a softkey location, not to a specific sequence title	6-142
Having a sequence jump to itself	6-142
TTL input decision making	6-142
Limit test decision making	6-142
Loop counter decision making	6-143
Naming Files Generated by a Sequence	6-143
HP-GL Considerations	6-143
Entering HP-GL Commands	6-143
Special Commands	6-144
Entering Sequences Using HP-IB	6-144
Reading Sequences Using HP-IB	6-144
Amplifier Testing	6-145
Amplifier parameters	6-145
Gain Compression	6-146
Metering the power level	6-148
Mixer Testing	6-149
Frequency Offset	6-149
Tuned Receiver	6-149
Mixer Parameters That You Can Measure	6-150
Accuracy Considerations	6-150
Attenuation at Mixer Ports	6-151
Filtering	6-152
Frequency Selection	6-153
LO Frequency Accuracy and Stability	6-153
Up-Conversion and Down-Conversion Definition	6-153
Conversion Loss	6-156
Isolation	6-156
LO Feedthru / LO to RF Leakage	6-156
RF Feedthru	6-157
SWR / Return Loss	6-157
Conversion Compression	6-158
Phase Measurements	6-158
Amplitude and Phase Tracking	6-159
Phase Linearity and Group Delay	6-159
Connection Considerations	6-161
Adapters	6-161
Fixtures	6-162
If You Want to Design Your Own Fixture	6-162
Reference Documents	6-163
General Measurement and Calibration Techniques	6-163
Fixtures and Non-Coaxial Measurements	6-163

7. Specifications and Measurement Uncertainties

Dynamic Range	7-1
HP 8753D Network Analyzer Specifications	7-2
HP 8753D (50Ω) with 7 mm Test Ports	7-2
Measurement Port Characteristics	7-2
Transmission Measurement Uncertainties	7-3
Reflection Measurement Uncertainties	7-4
HP 8753D (50Ω) with Type-N Test Ports	7-5
Measurement Port Characteristics	7-5
Transmission Measurement Uncertainties	7-6
Reflection Measurement Uncertainties	7-7
HP 8753D (50Ω) with 3.5 mm Test Ports	7-8
Measurement Port Characteristics	7-8
Transmission Measurement Uncertainties	7-9
Reflection Measurement Uncertainties	7-10
HP 8753D (75Ω) with Type-N Test Ports	7-11
Measurement Port Characteristics	7-11
Transmission Measurement Uncertainties	7-12
Reflection Measurement Uncertainties	7-13
HP 8753D (75Ω) with Type-F Test Ports	7-14
Measurement Port Characteristics	7-14
Transmission Measurement Uncertainties	7-15
Reflection Measurement Uncertainties	7-16
Transmission Measurement Uncertainties	7-18
Reflection Measurement Uncertainties	7-19
Transmission Measurement Uncertainties	7-21
Reflection Measurement Uncertainties	7-22
Transmission Measurement Uncertainties	7-24
Reflection Measurement Uncertainties	7-25
Instrument Specifications	7-26
HP 8753D Network Analyzer General Characteristics	7-33
Measurement Throughput Summary	7-33
Remote Programming	7-33
Interface	7-33
Transfer Formats	7-33
Interface Function Codes	7-33
Front Panel Connectors	7-34
Probe Power	7-34
Rear Panel Connectors	7-34
External Reference Frequency Input (EXT REF INPUT)	7-34
High-Stability Frequency Reference Output (10 MHz)(Option 001)	7-34
External Auxiliary Input (AUX INPUT)	7-34
External AM Input (EXT AM)	7-34
External Trigger (EXT TRIGGER)	7-35
Test Sequence Output (TEST SEQ)	7-35
Limit Test Output (LIMIT TEST)	7-35
Test Port Bias Input (BIAS CONNECT)	7-35
Video Output (EXT MON)	7-35
HP-IB	7-35
Parallel Port	7-36
RS-232	7-36
DIN Keyboard	7-36
Line Power	7-36

Environmental Characteristics	7-36
General Conditions	7-36
Operating Conditions	7-36
Non-Operating Storage Conditions	7-36
Weight	7-37
Cabinet Dimensions	7-37
Internal Memory	7-37

8. Menu Maps

9. Key Definitions

Where to Look for More Information	9-1
Guide Terms and Conventions	9-2
Analyzer Functions	9-2
Cross Reference of Key Function to Programming Command	9-48
Softkey Locations	9-69

10. Error Messages

Where to Look for More Information	10-1
Error Messages in Alphabetical Order	10-2
Error Messages in Numerical Order	10-26

11. Compatible Peripherals

Where to Look for More Information	11-1
Measurement Accessories Available	11-1
Calibration Kits	11-1
Verification Kit	11-2
HP 85029B 7 mm Verification Kit	11-2
Test Port Return Cables	11-2
HP 11857D 7 mm Test Port Return Cable Set	11-2
HP 11857B 75 Ohm Type-N Test Port Return Cable Set	11-2
Adapter Kits	11-2
HP 11852B 50 to 75 Ohm Minimum Loss Pad.	11-2
Transistor Test Fixtures	11-3
HP 11600B and 11602B Transistor Fixtures.	11-3
HP 11608A Option 003 Transistor Fixture.	11-3
HP 11858A Transistor Fixture Adapter.	11-3
System Accessories Available	11-4
System Cabinet	11-4
System Testmobile	11-4
Plotters and Printers	11-4
These plotters are compatible:	11-4
These printers are compatible:	11-4
Mass Storage	11-5
HP-IB Cables	11-5
Interface Cables	11-5
Keyboards	11-6
Controller	11-6
Sample Software	11-6
External Monitors	11-6
Connecting Peripherals	11-7
Connecting the Peripheral Device	11-7
Configuring the Analyzer for the Peripheral	11-8
If the Peripheral is a Printer	11-8
If the Peripheral is a Plotter	11-9

HPGL/2 Compatible Printer (used as a plotter)	11-9
Pen Plotter	11-11
If the Peripheral is a Power Meter	11-12
If the Peripheral is an External Disk Drive	11-12
If the Peripheral is a Computer Controller	11-12
Configuring the Analyzer to Produce a Time Stamp	11-13
HP-IB Programming Overview	11-14
HP-IB Operation	11-15
Device Types	11-15
Talker	11-15
Listener	11-15
Controller	11-15
HP-IB Bus Structure	11-16
Data Bus	11-16
Handshake Lines	11-16
Control Lines	11-16
HP-IB Requirements	11-17
HP-IB Operational Capabilities	11-18
HP-IB Status Indicators	11-19
Bus Device Modes	11-19
System-Controller Mode	11-20
Talker/Listener Mode	11-20
Pass-Control Mode	11-20
Setting HP-IB Addresses	11-20
Analyzer Command Syntax	11-21
Code Naming Convention	11-21
Valid Characters	11-22
Units	11-23
HP-IB Debug Mode	11-23

12. Preset State and Memory Allocation

Where to Look for More Information	12-1
Types of Memory and Data Storage	12-1
Volatile Memory	12-1
Non-Volatile Memory	12-2
Storing Data to Disk	12-4
Conserving Memory	12-5
Using Saved Calibration Sets	12-5
Preset State	12-6

A. The CITIfile Data Format and Keyword Reference

The CITIfile Data Format	A-1
Description and Overview	A-1
Data Formats	A-1
File and Operating System Formats	A-1
Definition of CITIfile Terms	A-2
A CITIfile Package	A-2
The CITIfile Header	A-2
An Array of Data	A-2
CITIfile Keyword	A-3
CITIfile Examples	A-4
Example 2, An 8510 Display Memory File	A-4
Example 3, 8510 Data file	A-4
Example 4, 8510 3-Term Frequency List Cal Set File	A-5
Conclusion	A-6

The CITIfile Keyword Reference A-7

Index

Figures

1-1. HP 8753D Front Panel	1-4
1-2. Analyzer Display (Single Channel, Cartesian Format)	1-6
1-3. HP 8753D Rear Panel	1-10
2-1. Basic Measurement Setup	2-3
2-2. Example of Viewing Both Channels Simultaneously	2-5
2-3. Example Dual Channel With Split Display On	2-6
2-4. Example of a Display Title	2-8
2-5. Active Marker Control Example	2-10
2-6. Active and Inactive Markers Example	2-10
2-7. Marker 1 as the Reference Marker Example	2-11
2-8. Example of a Fixed Reference Marker Using <code>ΔREF=ΔFIXED MKR</code>	2-12
2-9. Example of a Fixed Reference Marker Using <code>MKR ZERO</code>	2-13
2-10. Example of Coupled and Uncoupled Markers	2-14
2-11. Example of a Log Marker in Polar Format	2-15
2-12. Example of Impedance Smith Chart Markers	2-16
2-13. Example of Setting the Start Frequency Using a Marker	2-17
2-14. Example of Setting the Stop Frequency Using a Marker	2-17
2-15. Example of Setting the Center Frequency Using a Marker	2-18
2-16. Example of Setting the Frequency Span Using Marker 	2-19
2-17. Example of Setting the Reference Value Using a Marker	2-20
2-18. Example of Setting the Electrical Delay Using a Marker	2-21
2-19. Example of Searching for the Maximum Amplitude Using a Marker	2-22
2-20. Example of Searching for the Minimum Amplitude Using a Marker	2-23
2-21. Example of Searching for a Target Amplitude Using a Marker	2-24
2-22. Example of Searching for a Bandwidth Using Markers	2-25
2-23. Example Statistics of Measurement Data	2-26
2-24. Device Connections for Measuring a Magnitude Response	2-27
2-25. Example Magnitude Response Measurement Results	2-28
2-26. Example Insertion Phase Response Measurement	2-28
2-27. Phase Samples	2-29
2-28. Device Connections for Measuring Electrical Length	2-30
2-29. Linearly Changing Phase	2-31
2-30. Example Best Flat Line with Added Electrical Delay	2-32
2-31. Deviation From Linear Phase Example Measurement	2-33
2-32. Group Delay Example Measurement	2-34
2-33. Group Delay Example Measurement with Smoothing	2-34
2-34. Group Delay Example Measurement with Smoothing Aperture Increased	2-35
2-35. Connections for SAW Filter Example Measurement	2-36
2-36. Example Flat Limit Line	2-38
2-37. Example Flat Limit Lines	2-39
2-38. Sloping Limit Lines	2-40
2-39. Example Single Points Limit Line	2-41
2-40. Example Stimulus Offset of Limit Lines	2-44
2-41. Diagram of Gain Compression	2-45
2-42. Gain Compression Using Linear Sweep and <code>D2/D1 to D2 0N</code>	2-46

2-43. Gain Compression Using Power Sweep	2-48
2-44. Gain and Reverse Isolation	2-50
2-45. Typical Test Setup for Tuned Receiver Mode	2-51
2-46. Test Sequencing Help Instructions	2-54
2-47. Fundamental and 2nd Harmonic Power Levels in dBm	2-66
2-48. 2nd Harmonic Power Level in dBc	2-67
2-49. Device Connections for Time Domain Transmission Example Measurement	2-68
2-50. Time Domain Transmission Example Measurement	2-69
2-51. Gating in a Time Domain Transmission Example Measurement	2-70
2-52. Gate Shape	2-71
2-53. Gating Effects in a Frequency Domain Example Measurement	2-72
2-54. Device Connections for Reflection Time Domain Example Measurement	2-73
2-55. Device Response in the Frequency Domain	2-74
2-56. Device Response in the Time Domain	2-75
3-1. Down Converter Port Connections	3-3
3-2. Up Converter Port Connections	3-3
3-3. R-Channel External Connection	3-4
3-4. An Example Spectrum of RF, LO, and IF Signals Present in a Conversion Loss Measurement	3-7
3-5. Connections for R Channel and Source Calibration	3-8
3-6. Connections for a One-Sweep Power Meter Calibration for Mixer Measurements	3-9
3-7. Diagram of Measurement Frequencies	3-10
3-8. Measurement Setup from Display	3-10
3-9. Conversion Loss Example Measurement	3-11
3-10. Connections for Broad Band Power Meter Calibration	3-13
3-11. Connections for Receiver Calibration	3-14
3-12. Connections for a High Dynamic Range Swept IF Conversion Loss Measurement	3-15
3-13. Example of Swept IF Conversion Loss Measurement	3-16
3-14. Connections for a Response Calibration	3-18
3-15. Connections for a Conversion Loss Using the Tuned Receiver Mode	3-22
3-16. Example Fixed IF Mixer Measurement	3-23
3-17. Connections for a Group Delay Measurement	3-25
3-18. Group Delay Measurement Example	3-26
3-19. Conversion Loss and Output Power as a Function of Input Power Level Example	3-28
3-20. Connections for the First Portion of Conversion Compression Measurement	3-29
3-21. Connections for the Second Portion of Conversion Compression Measurement	3-30
3-22. Measurement Setup Diagram Shown on Analyzer Display	3-31
3-23. Example Swept Power Conversion Compression Measurement	3-32
3-24. Signal Flow in a Mixer Example	3-33
3-25. Connections for a Response Calibration	3-34
3-26. Connections for a Mixer Isolation Measurement	3-34
3-27. Example Mixer LO to RF Isolation Measurement	3-35
3-28. Connections for a Response Calibration	3-36
3-29. Connections for a Mixer RF Feedthrough Measurement	3-36
3-30. Example Mixer RF Feedthrough Measurement	3-37
4-1. Printer Connections to the Analyzer	4-3
4-2. Printing Two Measurements	4-7
4-3. Peripheral Connections to the Analyzer	4-8
4-4. Plot Components Available through Definition	4-12
4-5. Line Types Available	4-14
4-6. Locations of P1 and P2 in <code>SCALE PLOT [GRAT]</code> Mode	4-15
4-7. Plot Quadrants	4-17
4-8. Automatic File Naming Convention for LIF Format	4-19
4-9. Plot Filename Convention	4-26
4-10. Plotting Two Files on the Same Page	4-27

4-11. Plot Quadrants	4-28
4-12. Data Processing Flow Diagram	4-37
5-1. Standard Connections for a Response Error-Correction for Reflection Measurement	5-9
5-2. Standard Connections for Response Error-Correction for Transmission Measurements	5-10
5-3. Standard Connections for Receiver Calibration	5-11
5-4. Standard Connections for a Response and Isolation Error-Correction for Reflection Measurements	5-14
5-5. Standard Connections for a Response and Isolation Error-Correction for Transmission Measurements	5-16
5-6. Standard Connections for a One Port Reflection Error-Correction	5-18
5-7. Standard Connections for Full Two port Error-Correction	5-20
5-8. Sample-and-Sweep Mode for Power Meter Calibration	5-36
5-9. Continuous Correction Mode for Power Meter Calibration	5-37
5-10. Calibrating for Noninsertable Devices	5-39
5-11. Noninsertable Device	5-41
5-12. Adapters Needed	5-42
5-13. Two-Port Cal Set 1	5-43
5-14. Two-Port Cal Set 2	5-44
5-15. Calibrated Measurement	5-45
6-1. Simplified Block Diagram of the Network Analyzer System	6-2
6-2. Data Processing Flow Diagram	6-4
6-3. Active Channel Keys	6-8
6-4. Entry Block	6-9
6-5. Stimulus Function Block	6-11
6-6. Power Range Transitions in the Automatic Mode	6-14
6-7. Response Function Block	6-25
6-8. S-Parameters of a Two-Port Device	6-26
6-9. Reflection Impedance and Admittance Conversions	6-28
6-10. Transmission Impedance and Admittance Conversions	6-28
6-11. Log Magnitude Format	6-30
6-12. Phase Format	6-30
6-13. Group Delay Format	6-31
6-14. Standard and Inverse Smith Chart Formats	6-32
6-15. Polar Format	6-32
6-16. Linear Magnitude Format	6-33
6-17. Typical SWR Display	6-33
6-18. Real Format	6-34
6-19. Constant Group Delay	6-35
6-20. Higher Order Phase Shift	6-35
6-21. Rate of Phase Change Versus Frequency	6-36
6-22. Variations in Frequency Aperture	6-36
6-23. Dual Channel Displays	6-40
6-24. Effect of Averaging on a Trace	6-44
6-25. Effect of Smoothing on a Trace	6-45
6-26. IF Bandwidth Reduction	6-46
6-27. Markers on Trace	6-47
6-28. Directivity	6-51
6-29. Source Match	6-52
6-30. Load Match	6-52
6-31. Sources of Error in a Reflection Measurement	6-54
6-32. Reflection Coefficient	6-54
6-33. Effective Directivity E_{DF}	6-55
6-34. Source Match E_{SF}	6-55

6-35. Reflection Tracking E_{RF}	6-56
6-36. “Perfect Load” Termination	6-56
6-37. Measured Effective Directivity	6-57
6-38. Short Circuit Termination	6-57
6-39. Open Circuit Termination	6-58
6-40. Measured S_{11}	6-59
6-41. Major Sources of Error	6-60
6-42. Transmission Coefficient	6-60
6-43. Load Match E_{LF}	6-61
6-44. Isolation E_{XF}	6-62
6-45. Full Two-Port Error Model	6-63
6-46. Full Two-Port Error Model Equations	6-64
6-47. Typical Responses of Calibration Standards after Calibration	6-68
6-48. Response versus S_{11} 1-Port Calibration on Log Magnitude Format	6-69
6-49. Response versus S_{11} 1-Port Calibration on Smith Chart	6-70
6-50. Response versus Full Two-Port Calibration	6-70
6-51. HP 8753D functional block diagram for a 2-port error-corrected measurement system	6-86
6-52. 8-term TRL error model and generalized coefficients	6-87
6-53. Typical Measurement Set up	6-89
6-54. Test Setup for Continuous Sample Mode	6-97
6-55. Test Setup for Sample-and-Sweep Mode	6-97
6-56. Alternate and Chop Sweeps Overlaid	6-100
6-57. Instrument State Function Block	6-102
6-58. Typical Setup for the External Source Mode	6-110
6-59. Typical Test Setup for a Frequency Offset Measurement	6-113
6-60. Typical Harmonic Mode Test Setup	6-115
6-61. Device Frequency Domain and Time Domain Reflection Responses	6-118
6-62. A Reflection Measurement of Two Cables	6-120
6-63. Transmission Measurement in Time Domain Bandpass Mode	6-121
6-64. Time Domain Low Pass Measurements of an Unterminated Cable	6-123
6-65. Simulated Low Pass Step and Impulse Response Waveforms (Real Format)	6-124
6-66. Low Pass Step Measurements of Common Cable Faults (Real Format)	6-125
6-67. Time Domain Low Pass Measurement of an Amplifier Small Signal Transient Response	6-126
6-68. Transmission Measurements Using Low Pass Impulse Mode	6-127
6-69. Masking Example	6-128
6-70. Impulse Width, Sidelobes, and Windowing	6-128
6-71. The Effects of Windowing on the Time Domain Responses of a Short Circuit	6-130
6-72. Response Resolution	6-132
6-73. Range Resolution of a Single Discontinuity	6-132
6-74. Sequence of Steps in Gating Operation	6-133
6-75. Gate Shape	6-134
6-76. Amplifier Gain Measurement	6-135
6-77. Combined Effects of Amplitude and Phase Modulation	6-136
6-78. Separating the Amplitude and Phase Components of Test-Device-Induced Modulation	6-136
6-79. Range of a Forward Transform Measurement	6-137
6-80. Parallel Port Input and Output Bus Pin Locations in GPIO Mode	6-141
6-81. Amplifier Parameters	6-145
6-82. Swept Frequency Amplifier Measurement of Absolute Fundamental, 2nd and 3rd Harmonic Output Levels	6-145
6-83. Swept Frequency Amplifier Measurement of 2nd and 3rd Harmonic Distortion (dBc)	6-146
6-84. Diagram of Gain Compression	6-147

6-85. Swept Power Measurement of Amplifier's Fundamental Gain Compression and 2nd Harmonic Output Level	6-147
6-86. Test Configuration for Setting RF Input using Automatic Power Meter Calibration	6-148
6-87. Mixer Parameters	6-150
6-88. Conversion Loss versus Output Frequency Without Attenuators at Mixer Ports	6-151
6-89. Example of Conversion Loss versus Output Frequency Without Correct IF Signal Path Filtering	6-152
6-90. Example of Conversion Loss versus Output Frequency With Correct IF Signal Path Filtering and Attenuation at all Mixer Ports	6-152
6-91. Examples of Up Converters and Down Converters	6-153
6-92. Down Converter Port Connections	6-154
6-93. Up Converter Port Connections	6-155
6-94. Example Spectrum of RF, LO, and IF Signals Present in a Conversion Loss Measurement	6-156
6-95. Main Isolation Terms	6-156
6-96. Conversion Loss and Output Power as a Function of Input Power Level	6-158
6-97. Connections for an Amplitude and Phase Tracking Measurement Between Two Mixers	6-159
6-98. Adapter Considerations	6-161
7-1. External Trigger Circuit	7-35
11-1. Peripheral Connections to the Analyzer	11-7
11-2. HP-IB Bus Structure	11-16
11-3. Analyzer Single Bus Concept	11-19

Tables

0-1. Hewlett-Packard Sales and Service Offices	v
1-1. Comparing the HP 8753A/B/C/D	1-14
2-1. Connector Care Quick Reference	2-2
2-2. Gate Characteristics	2-71
4-1. Default Values for Printing Parameters	4-6
4-2. Default Pen Numbers and Corresponding Colors	4-13
4-3. Default Pen Numbers for Plot Elements	4-13
4-4. Default Line Types for Plot Elements	4-14
4-5. Plotting Parameter Default Values	4-16
4-6. HPGL Initialization Commands	4-23
4-7. HPGL Test File Commands	4-24
5-1. Differences between PORT EXTENSIONS and ELECTRICAL DELAY	5-3
5-2. Purpose and Use of Different Error-Correction Procedures	5-5
5-3. Typical Calibration Kit Standard and Corresponding Number	5-27
5-4. Characteristic Power Meter Calibration Sweep Speed and Accuracy	5-33
5-5. Band Switch Points	5-50
5-6. Typical Recall State Times	5-58
6-1. Minimum Cycle Time (in seconds)	6-17
6-2. Display Colors with Maximum Viewing Angle	6-43
6-3. Calibration Standard Types and Expected Phase Shift	6-67
6-4. Standard Definitions	6-78
6-5. Standard Class Assignments	6-82
6-6. Characteristic Power Meter Calibration Sweep Speed and Accuracy	6-99
6-7. External Source Capture Ranges	6-111
6-8. Maximum Fundamental Frequency using Harmonic Mode	6-116
6-9. Time Domain Reflection Formats	6-121
6-10. Minimum Frequency Ranges for Time Domain Low Pass	6-122
6-11. Impulse Width, Sidelobe Level, and Windowing Values	6-129
6-12. Gate Characteristics	6-134
7-1. HP 8753D Dynamic Range	7-1
7-2. Measurement Port Characteristics (Corrected*) for HP 8753D (50 Ω) with 7 mm Test Ports	7-2
7-3. Measurement Port Characteristics (Uncorrected*) for HP 8753D (50 Ω) with 7 mm Test Ports	7-2
7-4. Measurement Port Characteristics (Corrected)* for HP 8753D (50 Ω) with Type-N Test Ports	7-5
7-5. Measurement Port Characteristics (Corrected)* for HP 8753D (50 Ω) with 3.5 mm Test Ports	7-8
7-6. Measurement Port Characteristics (Corrected)* for HP 8753D (75 Ω) with Type-N Test Ports	7-11
7-7. Measurement Port Characteristics (Uncorrected)* [†] for HP 8753D (75 Ω) with Type-N Test Ports	7-11
7-8. Measurement Port Characteristics (Corrected)* for HP 8753D (75 Ω) using HP 85039A F-M Test Ports	7-14
7-9. Measurement Port Characteristics (Corrected)* for HP 8753D (75 Ω) using HP 85039A F-F Testports	7-17

7-10. Measurement Port Characteristics (Corrected)* for HP 8753D (75Ω) using HP 85039A M-M Testports	7-20
7-11. Measurement Port Characteristics (Corrected)* for HP 8753D (75Ω) using HP 85039A M-F Testports	7-23
9-1. Cross Reference of Key Function to Programming Command	9-48
9-2. Softkey Locations	9-70
11-1. Code Naming Convention	11-22
12-1. Memory Requirements of Calibration and Memory Trace Arrays	12-3
12-2. Suffix Character Definitions	12-4
12-3. Preset Conditions (1 of 5)	12-7
12-4. Power-on Conditions (versus Preset)	12-10
12-5. Results of Power Loss to Non-Volatile Memory	12-11

HP 8753D Description and Options

This chapter contains information on the following topics:

- Analyzer overview
- Analyzer description
- Front panel features
- Analyzer display
- Rear panel features and connectors
- Analyzer options available
- Service and support options
- Changes between the HP 8753 network analyzers

Where to Look for More Information

Additional information about many of the topics discussed in this chapter is located in the following areas:

- Chapter 2, “Making Measurements,” contains step-by-step procedures for making measurements or using particular functions.
- Chapter 4, “Printing, Plotting, and Saving Measurement Results,” contains instructions for saving to disk or the analyzer internal memory, and printing and plotting displayed measurements.
- Chapter 5, “Optimizing Measurement Results,” describes techniques and functions for achieving the best measurement results.
- Chapter 6, “Application and Operation Concepts,” contains explanatory-style information about many applications and analyzer operation.

Analyzer Description

The HP 8753D is a high performance vector network analyzer for laboratory or production measurements of reflection and transmission parameters. It integrates a high resolution synthesized RF source, an S-parameter test set, and a dual channel three-input receiver to measure and display magnitude, phase, and group delay responses of active and passive RF networks.

Two independent display channels and a large screen color display show the measured results of one or both channels, in rectangular or polar/Smith chart formats.

For information on options, refer to “Options Available” later in this chapter.

The analyzer has the additional following features:

■ Control

- Measurement functions selection with front panel keys and softkey menus.
- External keyboard compatibility that allows you to title files and control the analyzer.
- Internal automation, using test sequencing to program analyzer measurements and control other devices without an external controller.
- Test system automation with the addition of an external controller. This allows all of the analyzer’s measurement capabilities to be programmed over the Hewlett-Packard Interface Bus (HP-IB). (Refer to Chapter 11, “Compatible Peripherals” or the *HP 8753D Network Analyzer Programming Guide*.)
- A general purpose input/output (GPIO) bus that can control eight output bits and read five input bits through test sequencing. This can be useful for interfacing to material handlers or custom test sets.

■ Performance

- Automatic sweep time that selects the minimum sweep time for the given IF bandwidth, number of points, averaging mode, frequency range, and sweep type.
- Built-in service diagnostics are available to simplify troubleshooting procedures.
- Measurement flexibility through trace math, data averaging, trace smoothing, electrical delay, and accuracy enhancement.
- External source mode capability that allows you to phase lock the analyzer’s receiver to an external source. Refer to Chapter 6, “Applications and Operation Concepts.”
- Tuned receiver mode that allows you to use the receiver as a stand-alone device. Refer to Chapter 6, “Applications and Operation Concepts.”
- Complete reflection and transmission measurements in either 50 or 75 ohm impedance environments.
- Receiver/source frequency offset mode that allows you to set the analyzer’s receiver and source with a fixed frequency offset for mixer test applications.

■ **Accuracy**

- Accuracy enhancement methods that range from normalizing data to complete one or two port vector error correction with up to 1601 measurement points, and TRL*/LRM*. (Vector error correction reduces the effects of system directivity, frequency response, source and load match, and crosstalk.)
- Power meter calibration that allows you to use an HP-IB compatible power meter to monitor and correct the analyzer's output power at each data point. (The analyzer stores a power correction table that contains the correction values.)

■ **Printing, Plotting, and Saving**

- Direct print or plot output of displayed measurement results, with a time stamp if desired, to a compatible peripheral with a serial, parallel, or HP-IB interface.
- Instrument states storage in internal memory for the following times, or on disk indefinitely.
 - Temperature at 70 °C 250 days (0.68 year) characteristically
 - Temperature at 40 °C 1244 days (3.4 years) characteristically
 - Temperature at 25 °C 10 years characteristically
- LIF/DOS disk formats for saving instrument states and measurement data.
- Integration of a high capacity micro-floppy disk drive.

Front Panel Features

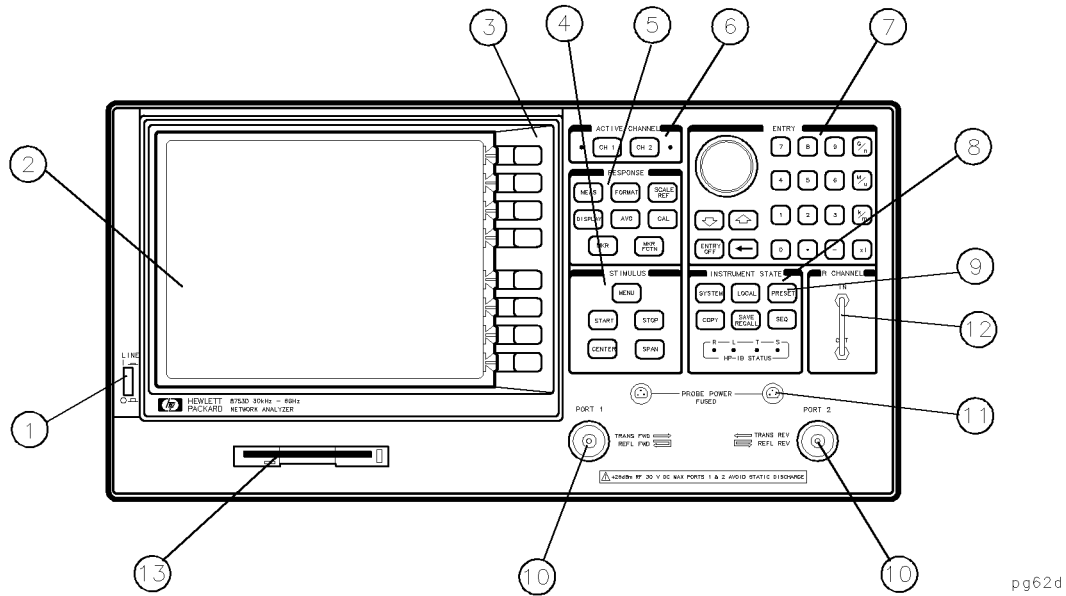

Figure 1-1. HP 8753D Front Panel

Figure 1-1 shows the location of the following front panel features and key function blocks. These features are described in more detail later in this chapter, and in Chapter 9, “Key Definitions.”

1. **LINE switch.** This switch controls ac power to the analyzer. 1 is on, 0 is off.
2. **Display.** This shows the measurement data traces, measurement annotation, and softkey labels. The display is divided into specific information areas, illustrated in Figure 1-2.
3. **Softkeys.** These keys provide access to menus that are shown on the display.
4. **STIMULUS function block.** The keys in this block allow you to control the analyzer source’s frequency, power, and other stimulus functions.
5. **RESPONSE function block.** The keys in this block allow you to control the measurement and display functions of the active display channel.
6. **ACTIVE CHANNEL keys.** The analyzer has two independent display channels. These keys allow you to select the active channel. Then any function you enter applies to this active channel.

7. **The ENTRY block.** This block includes the knob, the step \uparrow \downarrow keys, and the number pad. These allow you to enter numerical data and control the markers.

You can use the numeric keypad to select digits, decimal points, and a minus sign for numerical entries. You must also select a units terminator to complete value inputs.

8. **INSTRUMENT STATE function block.** These keys allow you to control channel-independent system functions such as the following:

- copying, save/recall, and HP-IB controller mode
- limit testing
- external source mode
- tuned receiver mode
- frequency offset mode
- test sequence function
- harmonic measurements (Option 002)
- time domain transform (Option 010)

HP-IB STATUS indicators are also included in this block.

9. **PRESET key.** This key returns the instrument to either a known factory preset state, or a user preset state that can be defined. Refer to Chapter 12, "Preset State and Memory Allocation," for a complete listing of the instrument preset condition.
10. **PORT 1 and PORT 2.** These ports output a signal from the source and receive input signals from a device under test. PORT 1 allows you to measure S_{12} and S_{11} . PORT 2 allows you to measure S_{21} and S_{22} .
11. **PROBE POWER connector.** This connector (fused inside the instrument) supplies power to an active probe for in-circuit measurements of ac circuits.
12. **R CHANNEL connectors.** These connectors allow you to apply an input signal to the analyzer's R channel, for frequency offset mode.
13. **Disk drive.** This 3.5 inch drive allows you to store and recall instrument states and measurement results for later analysis.

Analyzer Display

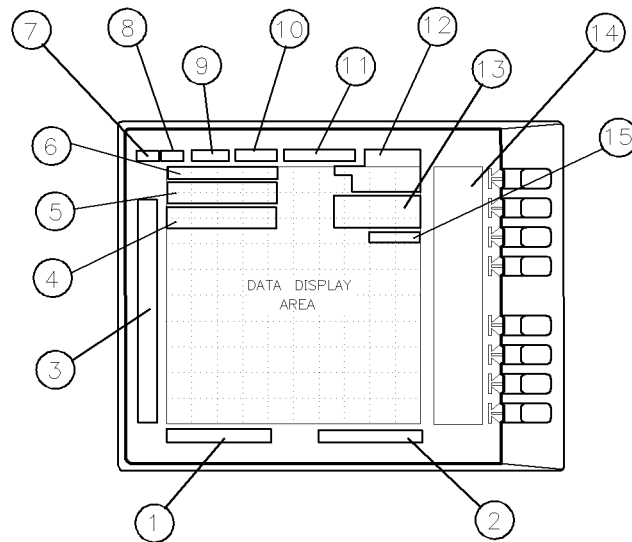

pg64d

Figure 1-2. Analyzer Display (Single Channel, Cartesian Format)

The analyzer display shows various measurement information:

- The grid where the analyzer plots the measurement data.
- The currently selected measurement parameters.
- The measurement data traces.

Figure 1-2 illustrates the locations of the different information labels described below.

In addition to the full-screen display shown in Figure 1-2, a split display is available, as described in Chapter 2, “Making Measurements.” In the split display mode, the analyzer provides information labels for each half of the display.

Several display formats are available for different measurements, as described under “**FORMAT**” in Chapter 9, “Key Definitions.”

1. **Stimulus Start Value.** This value could be any one of the following:
 - The start frequency of the source in frequency domain measurements.
 - The start time in CW mode (0 seconds) or time domain measurements.
 - The lower power value in power sweep.

When the stimulus is in center/span mode, the center stimulus value is shown in this space.

2. **Stimulus Stop Value.** This value could be any one of the following:
- The stop frequency of the source in frequency domain measurements.
 - The stop time in time domain measurements or CW sweeps.
 - The upper limit of a power sweep.

When the stimulus is in center/span mode, the span is shown in this space. The stimulus values can be blanked, as described under “**FREQUENCY BLANK** Key” in Chapter 9, “Key Definitions.”

(For CW time and power sweep measurements, the CW frequency is displayed centered between the start and stop times or power values.)

3. **Status Notations.** This area shows the current status of various functions for the active channel.

The following notations are used:

- Avg = Sweep-to-sweep averaging is on. The averaging count is shown immediately below. (See “**AVG** Key” in Chapter 9, “Key Definitions.”)
- Cor = Error correction is on. (For error-correction procedures, refer to Chapter 5, “Optimizing Measurement Results.” For error correction theory, refer to Chapter 6, “Application and Operation Concepts.”)
- C? = Stimulus parameters have changed from the error-corrected state, or interpolated error correction is on. (For error-correction procedures, refer to Chapter 5, “Optimizing Measurement Results.” For error correction theory, refer to Chapter 6, “Application and Operation Concepts.”)
- C2 = Full two-port error-correction is active and either the power range for each port is different (uncoupled), or the **TESTSET SW HOLD** is activated. The annotation occurs because the analyzer does not switch between the test ports every sweep under these conditions. The measurement stays on the active port after an initial cycling between the ports. (The active port is determined by the selected measurement parameter.) You can update all the parameters by pressing **MENU** **MEASURE RESTART**, or **MEAS** key.
- Del = Electrical delay has been added or subtracted, or port extensions are active. (See Chapter 6, “Application and Operation Concepts” and “**SCALE REF** Key” in Chapter 9, “Key Definitions.”)
- ext = Waiting for an external trigger.
- Ofs = Frequency offset mode is on. (See “Frequency Offset Operation” in Chapter 6, “Application and Operation Concepts.”)
- Of? = Frequency offset mode error, the IF frequency is not within 10 MHz of expected frequency. LO inaccuracy is the most likely cause. (See “Frequency Offset Operation” in Chapter 6, “Application and Operation Concepts.”)
- Gat = Gating is on (time domain Option 010 only). (For time domain measurement procedures, refer to Chapter 2, “Making Measurements.” For time domain theory, refer to Chapter 6 “Application and Operation Concepts.”)

- H=2 = Harmonic mode is on, and the second harmonic is being measured (harmonics Option 002 only). See “Analyzer Options Available” later in this chapter.)
- H=3 = Harmonic mode is on, and the third harmonic is being measured (harmonics Option 002 only). (See “Analyzer Options Available” later in this chapter.)
- Hld = Hold sweep. (See **HOLD** in Chapter 9, “Key Definitions.”)
- man = Waiting for manual trigger.
- PC = Power meter calibration is on. (For power meter calibration procedures, refer to Chapter 5, “Optimizing Measurement Results.” For power meter calibration theory, refer to Chapter 6, “Application and Operation Concepts.”)
- PC? = The analyzer’s source could not be set to the desired level, following a power meter calibration. (For power meter calibration procedures, refer to Chapter 5, “Optimizing Measurement Results.” For power meter calibration theory, refer to Chapter 6, “Application and Operation Concepts.”)
- P? = Source power is unlevelled at start or stop of sweep. (Refer to the *HP 8753D Network Analyzer Service Guide* for troubleshooting.)
- P↓ = Source power has been automatically set to minimum, due to receiver overload. (See **POWER** in Chapter 9, “Key Definitions.”)
- PRm = Power range is in manual mode.
- Smo = Trace smoothing is on. (See “**AVG**” in Chapter 9, “Key Definitions.”)
- tsH = Indicates that the test set hold mode is engaged.
- That is, a mode of operation is selected which would cause repeated switching of the step attenuator. This hold mode may be overridden. See **MEASURE RESTART** or **NUMBER OF GROUPS** in Chapter 9, “Key Definitions.”
- ↑ = Fast sweep indicator. This symbol is displayed in the status notation block when sweep time is less than 1.0 second. When sweep time is greater than 1.0 second, this symbol moves along the displayed trace.
- * = Source parameters changed: measured data in doubt until a complete fresh sweep has been taken.

4. **Active Entry Area.** This displays the active function and its current value.
5. **Message Area.** This displays prompts or error messages.
6. **Title.** This is a descriptive alpha-numeric string title that you define and enter through an attached keyboard or as described in Chapter 4, “Printing, Plotting, and Saving Measurement Results.”
7. **Active Channel.** This is the number of the current active channel, selected with the **CHAN 1** and **CHAN 2** keys. If dual channel is on with an overlaid display, both channel 1 and channel 2 appear in this area.
8. **Measured Input(s).** This shows the S-parameter, input, or ratio of inputs currently measured, as selected using the **MEAS** key. Also indicated in this area is the current display memory status.
9. **Format.** This is the display format that you selected using the **FORMAT** key.
10. **Scale/Div.** This is the scale that you selected using the **SCALE REF** key, in units appropriate to the current measurement.

11. **Reference Level.** This value is the reference line in Cartesian formats or the outer circle in polar formats, whichever you selected using the **(SCALE REF)** key. The reference level is also indicated by a small triangle adjacent to the graticule, at the left for channel 1 and at the right for channel 2 in Cartesian formats.
12. **Marker Values.** These are the values of the active marker, in units appropriate to the current measurement. (Refer to “Using Analyzer Display Markers” in Chapter 2, “Making Measurements.”)
13. **Marker Stats, Bandwidth.** These are statistical marker values that the analyzer calculates when you access the menus with the **(MARKER FCTN)** key. (Refer to “Using Analyzer Display Markers” in Chapter 2, “Making Measurements.”)
14. **Softkey Labels.** These menu labels redefine the function of the softkeys that are located to the right of the analyzer display.
15. **Pass Fail.** During limit testing, the result will be announced as PASS if the limits are not exceeded, and FAIL if any points exceed the limits.

Rear Panel Features and Connectors

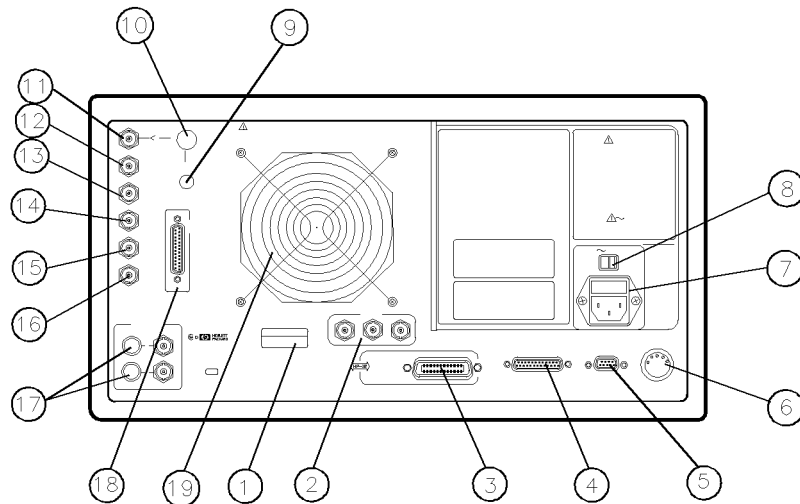

pg6134d

Figure 1-3. HP 8753D Rear Panel

Figure 1-3 illustrates the features and connectors of the rear panel, described below. Requirements for input signals to the rear panel connectors are provided in Chapter 7, “Specifications and Measurement Uncertainties.”

1. **Serial number plate.** The serial number of the instrument is located on this plate.
2. **EXTERNAL MONITOR: RED, GREEN, BLUE** Video output connectors provide analog red, green, and blue video signals which you can use to drive an analog multi-sync external monitor. The monitor must be compatible with the analyzer’s 25.5 kHz scan rate and video levels: 1 Vp-p, 0.7 V=white, 0 V=black, -0.3 V sync, sync on green.
3. **HP-IB connector.** This allows you to connect the analyzer to an external controller, compatible peripherals, and other instruments for an automated system. Refer to Chapter 11, “Compatible Peripherals,” in this document for HP-IB information, limitations, and configurations.
4. **PARALLEL interface.** This connector allows the analyzer to output to a peripheral with a parallel input. Also included, is a general purpose input/output (GPIO) bus that can control eight output bits and read five input bits through test sequencing. Refer to Chapter 11, “Compatible Peripherals,” for information on configuring a peripheral. Also refer to “Application and Operation Concepts” for information on GPIO.
5. **RS-232 interface.** This connector allows the analyzer to output to a peripheral with an RS-232 (serial) input.
6. **KEYBOARD input (DIN).** This connector allows you to connect an external keyboard. This provides a more convenient means to enter a title for storage files, as well as substitute for the analyzer’s front panel keyboard.
7. **Power cord receptacle, with fuse.** For information on replacing the fuse, refer to the *HP 8753D Network Analyzer Installation and Quick Start Guide* or the *HP 8753D Network Analyzer Service Guide*.
8. **Line voltage selector switch.** For more information refer to the *HP 8753D Network Analyzer Installation and Quick Start Guide*.
9. **10 MHZ REFERENCE ADJUST. (Option 1D5)**

10. 10 MHZ PRECISION REFERENCE OUTPUT. (Option 1D5)

- 11. EXTERNAL REFERENCE INPUT connector.** This allows for a frequency reference signal input that can phase lock the analyzer to an external frequency standard for increased frequency accuracy.

The analyzer automatically enables the external frequency reference feature when a signal is connected to this input. When the signal is removed, the analyzer automatically switches back to its internal frequency reference.

- 12. AUXILIARY INPUT connector.** This allows for a dc or ac voltage input from an external signal source, such as a detector or function generator, which you can then measure, using the S-parameter menu. (You can also use this connector as an analog output in service routines, as described in the service manual.)
- 13. EXTERNAL AM connector.** This allows for an external analog signal input that is applied to the ALC circuitry of the analyzer's source. This input analog signal amplitude modulates the RF output signal.
- 14. EXTERNAL TRIGGER connector.** This allows connection of an external negative-going TTL-compatible signal that will trigger a measurement sweep. The trigger can be set to external through softkey functions.
- 15. TEST SEQUENCE.** This outputs a TTL signal that can be programmed in a test sequence to be high or low, or pulse (10 μ seconds) high or low at the end of a sweep for robotic part handler interface.
- 16. LIMIT TEST.** This outputs a TTL signal of the limit test results as follows:
- Pass: TTL high
 - Fail: TTL low
- 17. BIAS INPUTS AND FUSES.** These connectors bias devices connected to port 1 and port 2. The fuses (1 A, 125 V) protect the port 1 and port 2 bias lines.
- 18. TEST SET INTERCONNECT.** This allows you to connect an HP 8753D Option 011 analyzer to an HP 85046A/B or 85047A S-parameter test set using the interconnect cable supplied with the test set. The S-parameter test set is then fully controlled by the analyzer.
- 19. Fan.** This fan provides forced-air cooling for the analyzer.

Analyzer Options Available

Option 1D5, High Stability Frequency Reference

Option 1D5 offers ± 0.05 ppm temperature stability from 0 to 60 °C (referenced to 25 °C).

Option 002, Harmonic Mode

Provides measurement of second or third harmonics of the test device's fundamental output signal. Frequency and power sweep are supported in this mode. Harmonic frequencies can be measured up to the maximum frequency of the receiver. However, the fundamental frequency may not be lower than 16 MHz.

Option 006, 6 GHz Operation

Option 006 extends the maximum source and receiver frequency of the analyzer to 6 GHz.

Option 010, Time Domain

This option displays the time domain response of a network by computing the inverse Fourier transform of the frequency domain response. It shows the response of a test device as a function of time or distance. Displaying the reflection coefficient of a network versus time determines the magnitude and location of each discontinuity. Displaying the transmission coefficient of a network versus time determines the characteristics of individual transmission paths. Time domain operation retains all accuracy inherent with the correction that is active in the frequency domain. The time domain capability is useful for the design and characterization of such devices as SAW filters, SAW delay lines, RF cables, and RF antennas.

Option 011, Receiver Configuration

Option 011 allows front panel access to the R, A, and B samplers and receivers. The transfer switch, couplers, and bias tees have been removed. Therefore, external accessories are required to make most measurements.

Option 075, 75 Ω Impedance

Option 075 offers 75 ohm impedance bridges with type-N test port connectors.

Option 1CM, Rack Mount Flange Kit Without Handles

Option 1CM is a rack mount kit containing a pair of flanges and the necessary hardware to mount the instrument, with handles detached, in an equipment rack with 482.6 mm (19 inches) horizontal spacing.

Option 1CP, Rack Mount Flange Kit With Handles

Option 1CP is a rack mount kit containing a pair of flanges and the necessary hardware to mount the instrument with handles attached in an equipment rack with 482.6 mm (19 inches) spacing.

Service and Support Options

The analyzer automatically includes a one-year on-site service warranty, where available. The following service and support products are available with an HP 8753D network analyzer at any time during or after the time of purchase. Additional service and support options may be available at some sites. Consult your local HP customer engineer for details.

On-Site System Verification (+ 23G)

On-site system verification (performed by a Hewlett-Packard customer engineer), confirms the system's error-corrected uncertainty performance by measuring traceable 7 mm devices. It provides a hardcopy listing of both ideal and actual data, together with a certificate of traceability. Preventive maintenance is performed at the time of system verification. Travel through Zone 3 (up to 100 miles/160 km from Hewlett-Packard's nearest service-responsible office) is included.

Standard System Maintenance Service (+ 02A)

This option provides four-hour, on-site response through Travel Zone 3 on all service requests for the HP 8753D (and a 50 ohm test set for Option 011), by a Hewlett-Packard customer engineer.

Basic System Maintenance Service (+ 02B)

This option provides next day on-site response through Travel Zone 3 on all service requests for the HP 8753D (and a 50 ohm test set for Option 011), by a Hewlett-Packard customer engineer.

Return to HP Full Service Agreement (+ 22A)

This option is a one-year service contract for any repair of the HP 8753D at a Hewlett-Packard repair facility. One complete calibration procedure is included.

Return to HP Repair Agreement (+ 22B)

This option provides repair of the HP 8753D at a Hewlett-Packard repair facility for one year. Following repair, the instrument is tested functionally but is not fully calibrated.

Return to HP Calibration Agreement (+ 22C)

This option provides a once-a-year complete calibration procedure at a Hewlett-Packard facility.

Return to HP Calibration (+ 22G)

This option is a one-time complete calibration procedure performed at a Hewlett-Packard facility. The procedure verifies that the HP 8753D is performing according to its published specifications.

Changes between the HP 8753 Network Analyzers

Table 1-1. Comparing the HP 8753A/B/C/D

Feature	8753A	8753B	8753C	8753D	8753D Opt 011
Fully integrated measurement system (built-in test set)	No	No	No	Yes	No
Test port power range (dBm)	†	†	†	+ 10 to -85	†
Auto/manual power range selecting	No	No	No	Yes	No
Port power coupling/uncoupling	No	No	No	Yes	No
Internal disk drive	No	No	No	Yes	Yes
Precision frequency reference (Option 1D5)	No	No	No	Yes	Yes
Frequency range - low end	300 kHz	300 kHz	300 kHz	30 kHz	30/300 kHz*
Ext. freq. range to 6 GHz (Option 006)	No	Yes	Yes	Yes	Yes
75Ω system impedance (Option 075)	†	†	†	Yes	†
TRL*/LRM* correction	No	No	No	Yes	Yes
Power meter calibration	No	Yes	Yes	Yes	Yes
Interpolated error correction	No	Yes	Yes	Yes	Yes
Max. error corrected measurement points	801	1601	1601	1601	1601
Segmented error correction in freq. list mode	No	No	Yes	Yes	Yes
Color CRT	No	No	Yes	Yes	Yes
Test sequencing	No	Yes	Yes	Yes	Yes
Automatic sweep time	No	Yes	Yes	Yes	Yes
External source capability	No	Yes	Yes	Yes	Yes
Tuned receiver mode	No	Yes	Yes	Yes	Yes
Printer/plotter buffer	No	Yes	Yes	Yes	Yes
Harmonic measurements (Option 002)	No	Yes	Yes	Yes	Yes
Frequency offset mode (mixer measurements)	No	Yes	Yes	Yes	Yes
dc bias to test device	†	†	†	Yes	†
Interfaces: RS-232, parallel, and DIN keyboard	No	No	No	Yes	Yes
User-defined preset	No	No	No	Yes	Yes
Non-volatile memory	16 Kbytes	16 Kbytes	16 Kbytes	512 Kbytes	512 Kbytes
Dynamic range					
30 kHz to 3 GHz	100 dB	100 dB	100 dB	110 dB‡	100 dB
3 GHz to 6 GHz	N/A	80 dB	80 dB	105 dB	110 dB
Real time clock	No	No	No	Yes	Yes

* 300 kHz to 3 GHz, without Option 006, or 30 kHz to 6 GHz, with Option 006.

† For this network analyzer, the feature is dependent on the test set being used.

‡ 90 dB from 30 kHz to 50 kHz, 100 dB from 300 kHz to 16 MHz.

Making Measurements

This Chapter contains the following example procedures for making measurements or using particular functions:

- Basic measurement sequence and example
 - Setting frequency range
 - Setting source power
- Analyzer display functions
- Analyzer marker functions
- Magnitude and insertion phase response
- Electrical length and phase distortion
 - Deviation from linear phase
 - Group delay
- Limit testing
- Gain compression
- Gain and reverse isolation
- High Power Measurements
- Tuned Receiver Mode
- Test sequencing
- Time domain
 - Transmission response
 - Reflection response
- Non-Coaxial Measurements

Where to Look for More Information

Additional information about many of the topics discussed in this Chapter is located in the following areas:

- Chapter 4, “Printing, Plotting, and Saving Measurement Results,” contains instructions for saving to disk or the analyzer internal memory, and printing and plotting displayed measurements.
- Chapter 5, “Optimizing Measurement Results,” describes techniques and functions for achieving the best measurement results.
- Chapter 6, “Application and Operation Concepts,” contains explanatory-style information about many applications and analyzer operation.
- Chapter 9, “Key Definitions,” describes all the front panel keys and softkeys.
- Chapter 11, “Compatible Peripherals,” lists measurement and system accessories, and other applicable equipment compatible with the analyzer.

Principles of Microwave Connector Care

Proper connector care and connection techniques are critical for accurate, repeatable measurements.

Refer to the calibration kit documentation for connector care information. Prior to making connections to the network analyzer, carefully review the information about inspecting, cleaning and gaging connectors.

Having good connector care and connection techniques extends the life of these devices. In addition, you obtain the most accurate measurements.

This type of information is typically located in Chapter 3 of the calibration kit manuals.

For additional connector care instruction, contact your local Hewlett-Packard Sales and Service Office about course numbers HP 85050A+24A and HP 85050A+24D.

See the following table for quick reference tips about connector care.

Table 2-1. Connector Care Quick Reference

Handling and Storage	
Do	Do Not
Keep connectors clean Extend sleeve or connector nut Use plastic end-caps during storage	Touch mating-plane surfaces Set connectors contact-end down
Visual Inspection	
Do	Do Not
Inspect all connectors carefully Look for metal particles, scratches, and dents	Use a damaged connector - ever
Connector Cleaning	
Do	Do Not
Try compressed air first Use isopropyl alcohol Clean connector threads	Use any abrasives Get liquid into plastic support beads
Gaging Connectors	
Do	Do Not
Clean and zero the gage before use Use the correct gage type Use correct end of calibration block Gage all connectors before first use	Use an out-of-spec connector
Making Connections	
Do	Do Not
Align connectors carefully Make preliminary connection lightly Turn only the connector nut Use a torque wrench for final connect	Apply bending force to connection Over tighten preliminary connection Twist or screw any connection Tighten past torque wrench "break" point

Basic Measurement Sequence and Example

Basic Measurement Sequence

There are five basic steps when you are making a measurement.

1. Connect the device under test and any required test equipment.

Caution Damage may result to the device under test if it is sensitive to analyzer's default output power level. To avoid damaging a sensitive DUT, perform step 2 before step 1.

2. Choose the measurement parameters.
3. Perform and apply the appropriate error-correction.
4. Measure the device under test.
5. Output the measurement results.

Basic Measurement Example

This example procedure shows you how to measure the transmission response of a bandpass filter.

Step 1. Connect the device under test and any required test equipment.

1. Make the connections as shown in Figure 2-1.

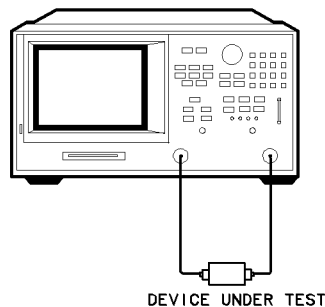

pg6111d

Figure 2-1. Basic Measurement Setup

Step 2. Choose the measurement parameters.

2. Press **PRESET**.

To set preset to "Factory Preset," press:

PRESET: FACTORY **PRESET**

Setting the Frequency Range.

3. To set the center frequency to 134 MHz, press:

CENTER **134** **M/μ**

- To set the span to 30 MHz, press:

SPAN **30** **M/μ**

Note You could also press the **START** and **STOP** keys and enter the frequency range limits as start frequency and stop frequency values.

Setting the Source Power.

- To change the power level to -5 dBm, press:

MENU **POWER** **-5** **x1**

Note You could also press **POWER RANGE MAN** **POWER RANGES** and select one of the power ranges to keep the power setting within the defined range.

Setting the Measurement.

- To change the number of measurement data points to 101, press:

MENU **NUMBER OF POINTS** **⇓**

- To select the transmission measurement, press:

MEAS **Trans:FWD S21 (B/R)**

- To view the data trace, press:

SCALE REF **AUTOSCALE**

Step 3. Perform and apply the appropriate error-correction.

- Refer to the “Optimizing Measurement Results” Chapter for procedures on correcting measurement errors.
- To save the instrument state and error-correction in the analyzer internal memory, press:

SAVE/RECALL **SELECT DISK** **INTERNAL MEMORY** **RETURN** **SAVE STATE**

Step 4. Measure the device under test.

- Replace any standard used for error-correction with the device under test.
- To measure the insertion loss of the bandpass filter, press:

MARKER **134** **M/μ**

Step 5. Output the measurement results.

- To create a hardcopy of the measurement results, press:

COPY **PRINT MONOCHROME** (or **PLOT**)

Refer to Chapter 4, “Printing, Plotting, and Saving Measurement Results,” for procedures on how to define a print, plot, or save. For information on configuring a peripheral, refer to Chapter 11, “Compatible Peripherals.”

Using the Display Functions

To View Both Measurement Channels

In some cases, you may want to view more than one measured parameter at a time. Simultaneous gain and phase measurements for example, are useful in evaluating stability in negative feedback amplifiers. You can easily make such measurements using the dual channel display.

1. To see both channels simultaneously, press:

DISPLAY DUAL CHAN ON

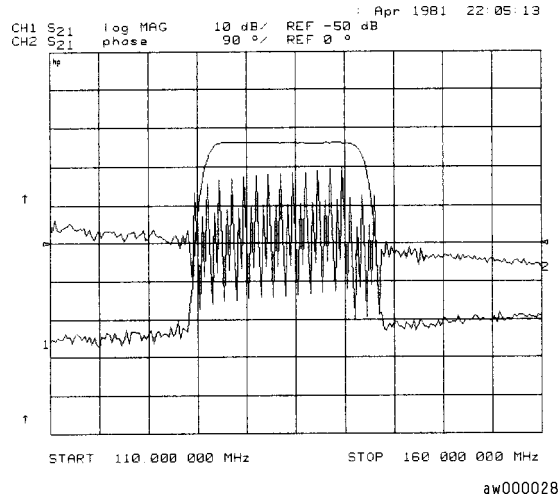

Figure 2-2. Example of Viewing Both Channels Simultaneously

- You can view the measurements on separate displays, press: **MORE SPLIT DISP ON** The analyzer shows channel 1 on the upper half of the display and channel 2 on the lower half of the display. The analyzer also defaults to measuring S_{11} on channel 1 and S_{21} on channel 2.

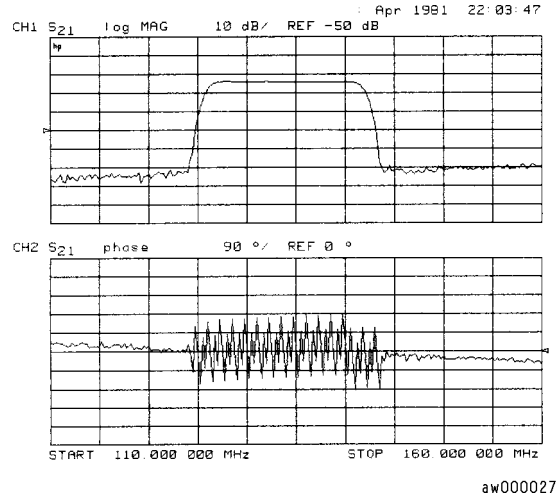

Figure 2-3. Example Dual Channel With Split Display On

- To return to one display, press: **SPLIT DISPLAY OFF**

Note You can control the stimulus functions of the two channels independent of each other, by pressing **(MENU) COUPLED CH OFF**.

To Save a Data Trace to the Display Memory

Press **(DISPLAY) DATA→MEMORY** to store the current active measurement data in the memory of the active channel.

The data trace is now also the memory trace. You can use a memory trace for subsequent math manipulations.

To View the Measurement Data and Memory Trace

The analyzer default setting shows you the current measurement data for the active channel.

- To view a data trace that you have already stored to the active channel memory, press:

(DISPLAY) MEMORY

This is the only memory display mode where you can change the smoothing and gating of the memory trace.

- To view both the memory trace and the current measurement data trace, press:

(DISPLAY) DATA and MEMORY

To Divide Measurement Data by the Memory Trace

You can use this feature for ratio comparison of two traces, for example, measurements of gain or attenuation.

1. You must have already stored a data trace to the active channel memory, as described in “To Save a Data Trace to the Display Memory.”
2. Press **(DISPLAY) DATA/MEM** to divide the data by the memory.

The analyzer normalizes the data to the memory, and shows the results.

To Subtract the Memory Trace from the Measurement Data Trace

You can use this feature for storing a measured vector error, for example, directivity. Then, you can later subtract it from the device measurement.

1. You must have already stored a data trace to the active channel memory, as described in “To Save a Data Trace to the Display Memory.”
2. Press **(DISPLAY) DATA-MEM** to subtract the memory from the measurement data.

The analyzer performs a vector subtraction on the complex data.

To Ratio Measurements in Channel 1 and 2

You may want to use this feature when making amplifier measurements to produce a trace that represents gain compression. For example, with the channels uncoupled, you can increase the power for channel 2 while channel 1 remains unchanged. This will allow you to observe the gain compression on channel 2 .

1. Press **(MENU) COUPLED CH OFF** to uncouple the channels.
2. Make sure that both channels must have the same number of points.
 - a. Press **(CHAN 1) (MENU) NUMBER OF POINTS** and notice the number of points setting, shown on the analyzer display.
 - b. Press **(CHAN 2) (MENU) NUMBER OF POINTS** and enter the same value that you observed for the channel 1 setting.
3. Press **(DISPLAY) DUAL CHAN ON MORE D2/D1 TO D2 ON** to ratio channels 1 and 2, and put the results in the channel 2 data array. This ratio is applied to the complex data.
4. Refer to Chapter “Measuring Gain Compression” for the procedure on identifying the 1 dB compression point.

To Title the Active Channel Display

1. Press **DISPLAY** **MORE** **TITLE** to access the title menu.
2. Press **ERASE TITLE** and enter the title you want for your measurement display.
 - If you have a DIN keyboard attached to the analyzer, type the title you want from the keyboard. Then press **ENTER** to enter the title into the analyzer. You can enter a title that has a maximum of 50 characters.
 - If you do not have a DIN keyboard attached to the analyzer, enter the title from the analyzer front panel.
 - a. Turn the front panel knob to move the arrow pointer to the first character of the title.
 - b. Press **SELECT LETTER**.
 - c. Repeat the previous two steps to enter the rest of the characters in your title. You can enter a title that has a maximum of 50 characters.
 - d. Press **DONE** to complete the title entry.

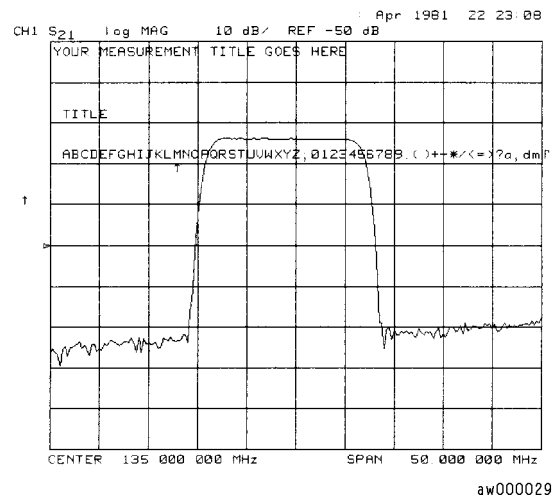

Figure 2-4. Example of a Display Title

Using Analyzer Display Markers

The analyzer markers provide numerical readout of trace data. You can control the marker search, the statistical functions, and the capability for quickly changing stimulus parameters with markers, from the **MARKER FCTN** key.

Markers have a stimulus value (the x-axis value in a Cartesian format) and a response value (the y-axis value in a Cartesian format). In a polar or Smith chart format, the second part of a complex data pair is also provided as an auxiliary response value. When you switch on a marker, and no other function is active, the analyzer shows the marker stimulus value in the active entry area. You can control the marker with the front panel knob, the step keys, or the front panel numeric keypad.

- If you activate both data and memory traces, the marker values apply to the data trace.
- If you activate only the memory trace, the marker values apply to the memory trace.
- If you activate a memory math function (data/memory or data-memory), the marker values apply to the trace resulting from the memory math function.

The examples in this section are shown with filter measurement results. The measurement parameters are set as follows:

MEAS Trans: FWD S21 (B/R)

CENTER 134 (M/ μ)

SPAN 25 (M/ μ)

To Use Continuous and Discrete Markers

The analyzer can either place markers on discrete measured points, or move the markers continuously along a trace by interpolating the data value between measured points.

Press **MARKER FCTN** **MARKER MODE MENU** and select one of the following choices:

- Choose **MARKERS: CONTINUOUS** if you want the analyzer to place markers at any point on the trace, by interpolating between measured points. This default mode allows you to conveniently obtain round numbers for the stimulus value.
- Choose **MARKERS: DISCRETE** if you want the analyzer to place markers only on measured trace points determined by the stimulus settings. This may be the best mode to use with automated testing, using a computer or test sequencing because the analyzer does not interpolate between measured points.

Note Using **MARKERS: DISCRETE** will also affect marker search and positioning functions when the value entered in a search or positioning function does not exist as a measurement point.

To Activate Display Markers

To switch on marker 1 and make it the active marker, press:

MARKER **MARKER 1**

The active marker appears on the analyzer display as ▽. The active marker stimulus value is displayed in the active entry area. You can modify the stimulus value of the active marker, using the front panel knob or numerical keypad. All of the marker response and stimulus values are displayed in the upper right corner of the display.

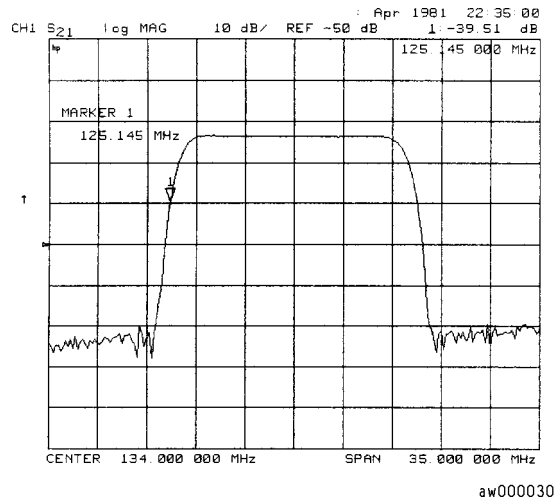

Figure 2-5. Active Marker Control Example

To switch on the corresponding marker and make it the active marker, press:

MARKER 2, **MARKER 3**, **MARKER 4**, or **MARKER 5**

All of the markers, other than the active marker, become inactive and are represented on the analyzer display as △.

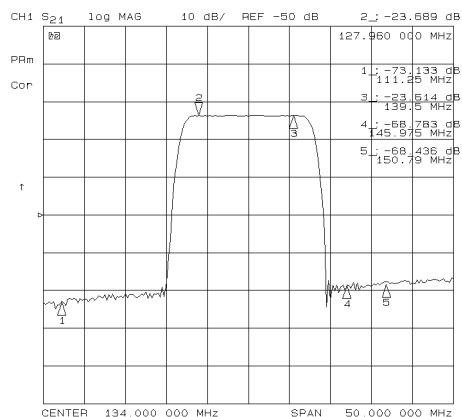

Figure 2-6. Active and Inactive Markers Example

To switch off all of the markers, press:

ALL OFF

To Use Delta (Δ) Markers

This is a relative mode, where the marker values show the position of the active marker relative to the delta reference marker. You can switch on the delta mode by defining one of the five markers as the delta reference.

1. Press **MARKER** Δ **MODE MENU** Δ **REF=1** to make marker 1 a reference marker.
2. To move marker 1 to any point that you want to reference:
 - a. Turn the front panel knob.OR
 - a. Enter the frequency value (relative to the reference marker) on the numeric keypad.
3. Press **MARKER 2** and move marker 2 to any position that you want to measure in reference to marker 1.

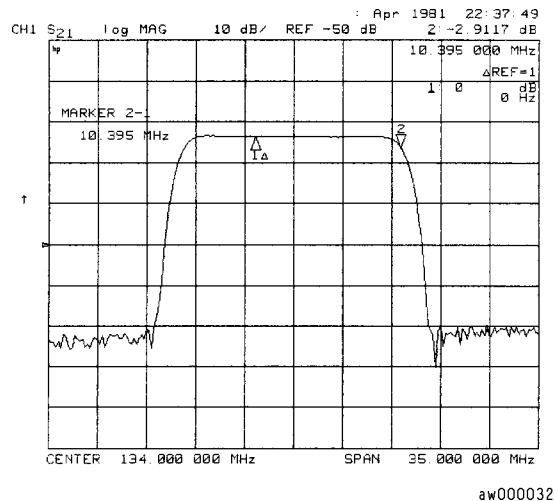

Figure 2-7. Marker 1 as the Reference Marker Example

4. To change the reference marker to marker 2, press:

Δ **MODE MENU** Δ **REF=2**

To Activate a Fixed Marker

When a reference marker is fixed, it does not rely on a current trace to maintain its fixed position. The analyzer allows you to activate a fixed marker with one of the following key sequences:

- **MARKER** Δ **MODE MENU** Δ **REF= Δ FIXED MKR**
- **MARKER** **MKR ZERO**

Using the Δ REF= Δ FIXED MKR Key to activate a Fixed Reference Marker

1. To set the frequency value of a fixed marker that appears on the analyzer display, press:

MARKER Δ MODE MENU Δ REF= Δ FIXED MKR Δ MODE MENU FIXED MKR POSITION

FIXED MKR STIMULUS and turn the front panel knob or enter a value from the front panel keypad.

The marker is shown on the display as a small delta (Δ), smaller than the inactive marker triangles.

2. To set the response value (dB) of a fixed marker, press:

FIXED MKR VALUE and turn the front panel knob or enter a value from the front panel keypad.

In a Cartesian format the setting is the y-axis value. In polar or Smith chart format, with a magnitude/phase marker, a real/imaginary marker, an R+jX marker, or a G+jB marker, the setting applies to the first part of the complex data pair. (Fixed marker response values are always uncoupled in the two channels.)

3. To set the auxiliary response value of a fixed marker when you are viewing a polar or Smith format, press:

FIXED MKR AUX VALUE and turn the front panel knob or enter a value from the front panel keypad.

This value is the second part of complex data pair, and applies to a magnitude/phase marker, a real/imaginary marker, an R+jX marker, or a G+jB marker. (Fixed marker auxiliary response values are always uncoupled in the two channels.)

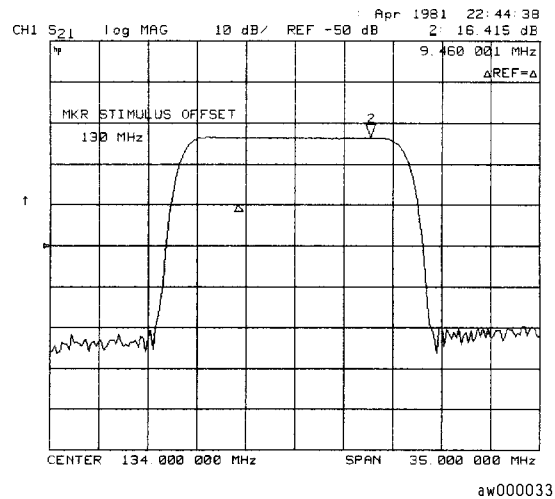

Figure 2-8.

Example of a Fixed Reference Marker Using Δ REF= Δ FIXED MKR

Using the MKR ZERO Key to Activate a Fixed Reference Marker

Marker zero enters the position of the active marker as the Δ reference position. Alternatively, you can specify the fixed point with **FIXED MKR POSITION**. Marker zero is canceled by switching delta mode off.

1. To place marker 1 at a point that you would like to reference, press:

MARKER and turn the front panel knob or enter a value from the front panel keypad.

2. To measure values along the measurement data trace, relative to the reference point that you set in the previous step, press:

MKR ZERO and turn the front panel knob or enter a value from the front panel keypad.

3. To move the reference position, press:

MODE MENU **FIXED MKR POSITION** **FIXED MKR STIMULUS** and turn the front panel knob or enter a value from the front panel keypad.

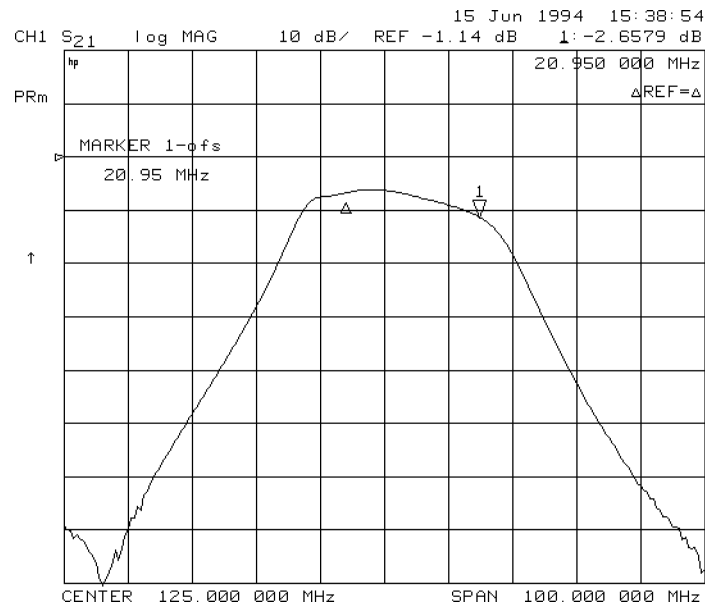
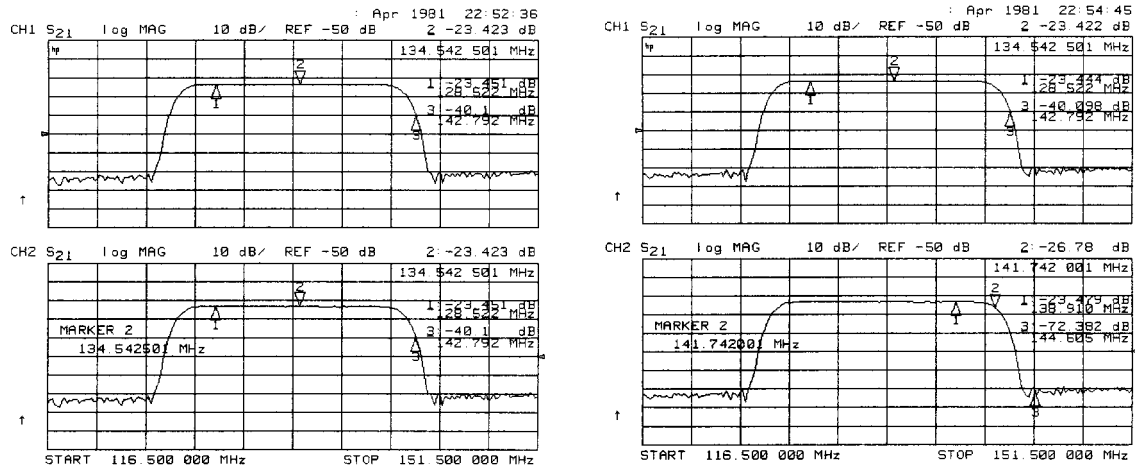

Figure 2-9. Example of a Fixed Reference Marker Using **MKR ZERO**

To Couple and Uncouple Display Markers

At a preset state, the markers have the same stimulus values on each channel, but they can be uncoupled so that each channel has independent markers.

- Press **(MARKER FCTN)** **MARKER MODE MENU** and select from the following keys:
 - Choose **MARKERS: COUPLED** if you want the analyzer to couple the marker stimulus values for the two display channels.
 - Choose **MARKERS: UNCOUPLED** if you want the analyzer to uncouple the marker stimulus values for the two display channels. This allows you to control the marker stimulus values independently for each channel.



pg6235

Figure 2-10. Example of Coupled and Uncoupled Markers

To Use Polar Format Markers

The analyzer can display the marker value as magnitude and phase, or as a real/imaginary pair: **LIN MKR** gives linear magnitude and phase, **LOG MKR** gives log magnitude and phase, **Re/Im** gives the real value first, then the imaginary value.

You can use these markers only when you are viewing a polar display format. (The format is available from the **(FORMAT)** key.)

Note For greater accuracy when using markers in the polar format, it is recommended to activate the discrete marker mode. Press **(MARKER FCTN)** **MKR MODE MENU** **MARKERS:DISCRETE**.

- To access the polar markers, press:

(FORMAT) **POLAR**
(MARKER FCTN) **MARKER MODE MENU** **POLAR MKR MENU**

2. Select the type of polar marker you want from the following choices:
 - Choose **LIN MKR** if you want to view the magnitude and the phase of the active marker. The magnitude values appear in units and the phase values appear in degrees.
 - Choose **LOG MKR** if you want to view the logarithmic magnitude and the phase of the active marker. The magnitude values appear in dB and the phase values appear in degrees.
 - Choose **Re/Im MKR** if you want to view the real and imaginary pair, where the complex data is separated into its real part and imaginary part. The analyzer shows the first marker value the real part ($M \cos \theta$), and the second value is the imaginary part ($M \sin \theta$, where M =magnitude).

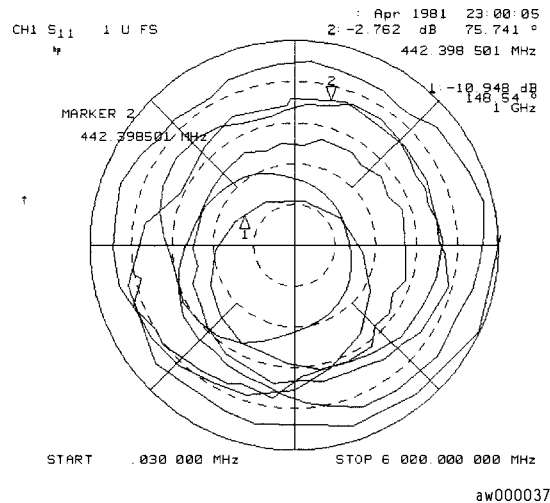

Figure 2-11. Example of a Log Marker in Polar Format

To Use Smith Chart Markers

The amount of power reflected from a device is directly related to the impedance of the device and the measuring system. Each value of the reflection coefficient (Γ) uniquely defines a device impedance; $\Gamma = 0$ only occurs when the device and analyzer impedance are exactly the same. The reflection coefficient for a short circuit is: $\Gamma = 1 \angle 180^\circ$. Every other value for Γ also corresponds uniquely to a complex device impedance, according to the equation:

$$Z_L = [(1 + \Gamma) / (1 - \Gamma)] \times Z_0$$

where Z_L is your test device impedance and Z_0 is the measuring system's characteristic impedance.

Note For greater accuracy when using markers in the Smith chart format, it is recommended to activate the discrete marker mode. Press **(MARKER FCTN) MKR MODE MENU MARKERS:DISCRETE**.

1. Press **(FORMAT) SMITH CHART**.
2. Press **(MARKER FCTN) MARKER MODE MENU SMITH MKR MENU** and turn the front panel knob or enter a value from the front panel keypad to read the resistive and reactive components of the complex impedance at any point along the trace. This is the default Smith chart marker.

The marker annotation tells that the complex impedance is capacitive in the bottom half of the Smith chart display and is inductive in the top half of the display.

- Choose **LIN MKR** if you want the analyzer to show the linear magnitude and the phase of the reflection coefficient at the marker.
- Choose **LOG MKR** if you want the analyzer to show the logarithmic magnitude and the phase of the reflection coefficient at the active marker. This is useful as a fast method of obtaining a reading of the log magnitude value without changing to log magnitude format.
- Choose **Re/Im MKR** if you want the analyzer to show the values of the reflection coefficient at the marker as a real and imaginary pair.
- Choose **R+jX MKR** to show the real and imaginary parts of the device impedance at the marker. Also shown is the equivalent series inductance or capacitance (the series resistance and reactance, in ohms).
- Choose **G+jB MKR** to show the complex admittance values of the active marker in rectangular form. The active marker values are displayed in terms of conductance (in Siemens), susceptance, and equivalent parallel circuit capacitance or inductance. Siemens are the international unit of admittance and are equivalent to mhos (the inverse of ohms).

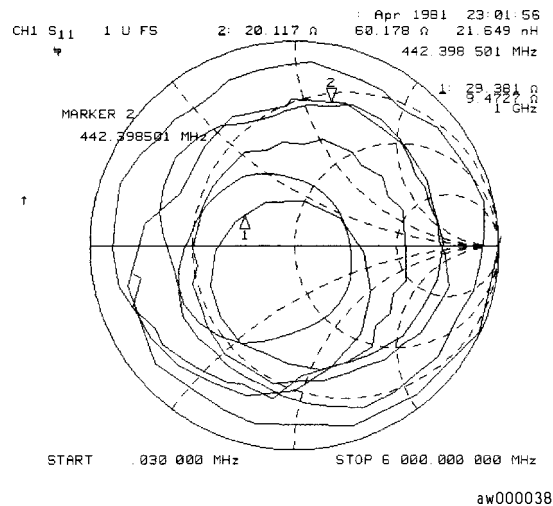

Figure 2-12. Example of Impedance Smith Chart Markers

To Set Measurement Parameters Using Markers

The analyzer allows you to set measurement parameters with the markers, without going through the usual key sequence. You can change certain stimulus and response parameters to make them equal to the current active marker value.

Setting the Start Frequency

1. Press **MARKER FCTN** and turn the front panel knob or enter a value from the front panel keypad to position the marker at the value that you want for the start frequency.
2. Press **MARKER—START** to change the start frequency value to the value of the active marker.

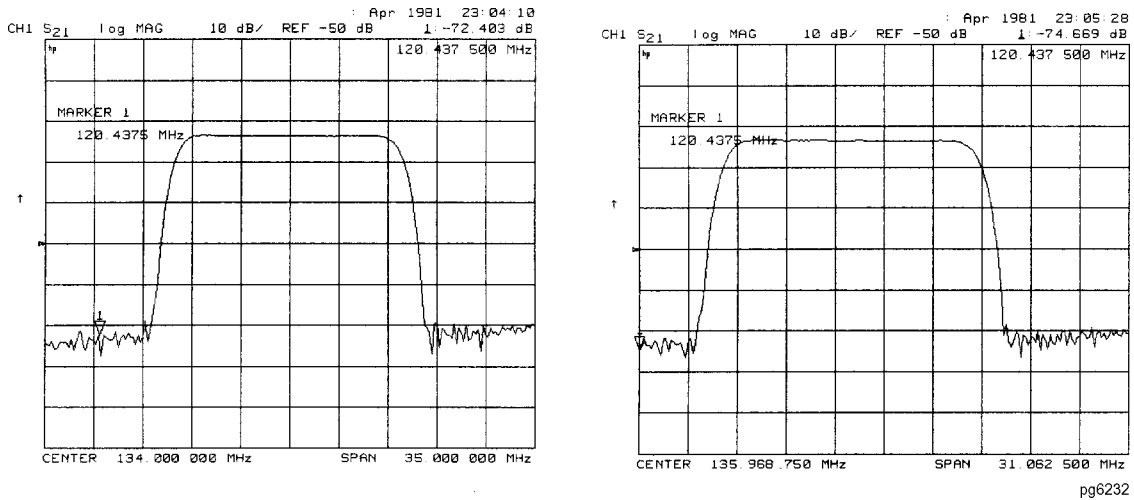

Figure 2-13. Example of Setting the Start Frequency Using a Marker

Setting the Stop Frequency

1. Press **MARKER FCTN** and turn the front panel knob or enter a value from the front panel keypad to position the marker at the value that you want for the stop frequency.
2. Press **MARKER—STOP** to change the stop frequency value to the value of the active marker.

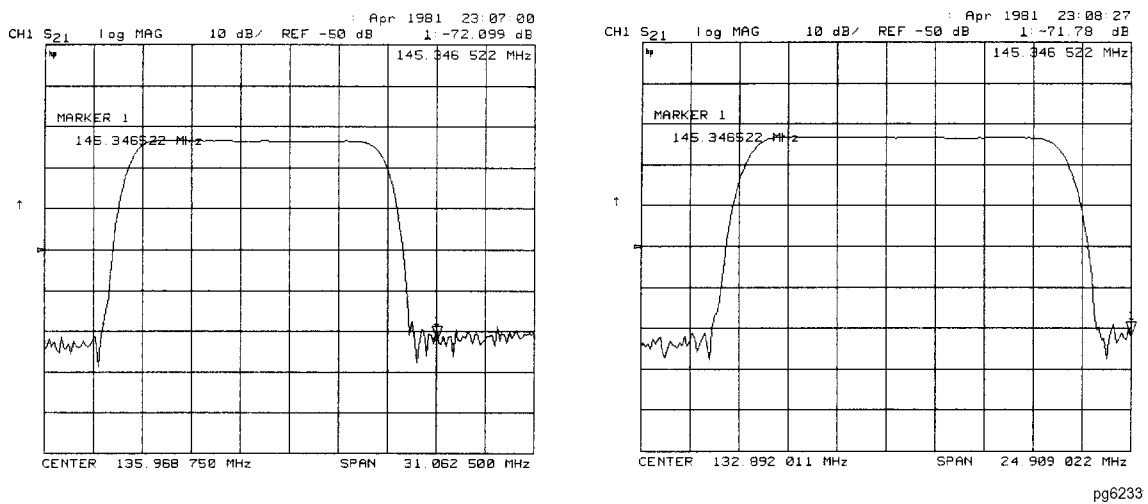
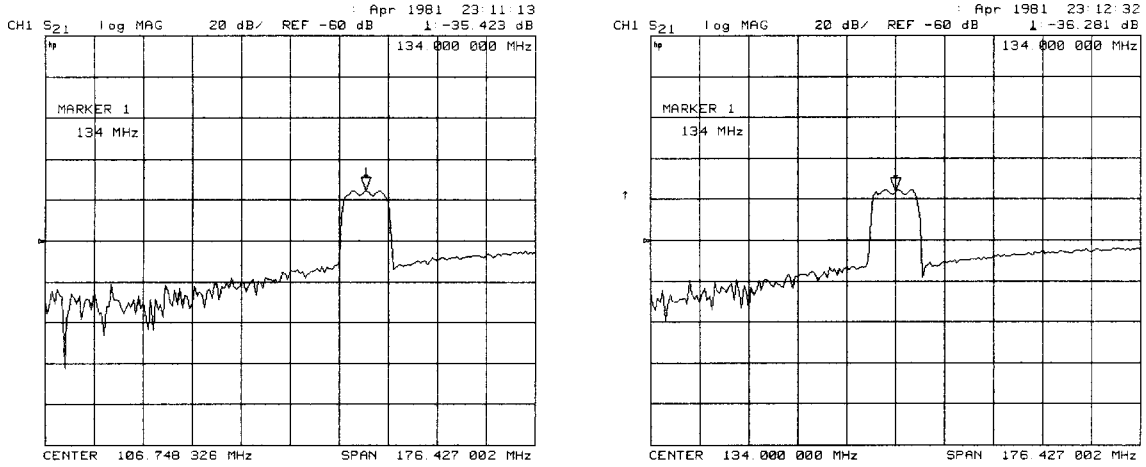

Figure 2-14. Example of Setting the Stop Frequency Using a Marker

Setting the Center Frequency

1. Press **MARKER FCTN** and turn the front panel knob or enter a value from the front panel keypad to position the marker at the value that you want for the center frequency.
2. Press **MARKER—CENTER** to change the center frequency value to the value of the active marker.



pg6234

Figure 2-15. Example of Setting the Center Frequency Using a Marker

Setting the Frequency Span

You can set the span equal to the spacing between two markers. If you set the center frequency before you set the frequency span, you will have a better view of the area of interest.

1. Press **MARKER** **ΔMODE MENU** **ΔREF=1** **MARKER 2**.
2. Turn the front panel knob or enter a value from the front panel keypad to position the markers where you want the frequency span.

Iterate between marker 1 and marker 2 by pressing **Marker 1** and **MARKER 2**, respectively, and turning the front panel knob or entering values from the front panel keypad to position the markers around the center frequency. When finished positioning the markers, make sure that marker 2 is selected as the active marker.

Note Step 2 can also be performed using **MKR ZERO** and **MARKER 1**. However, when using this method, it will not be possible to iterate between marker zero and marker 1.

3. Press **MARKER FCTN** **MARKER—SPAN** to change the frequency span to the range between marker 1 and marker 2.

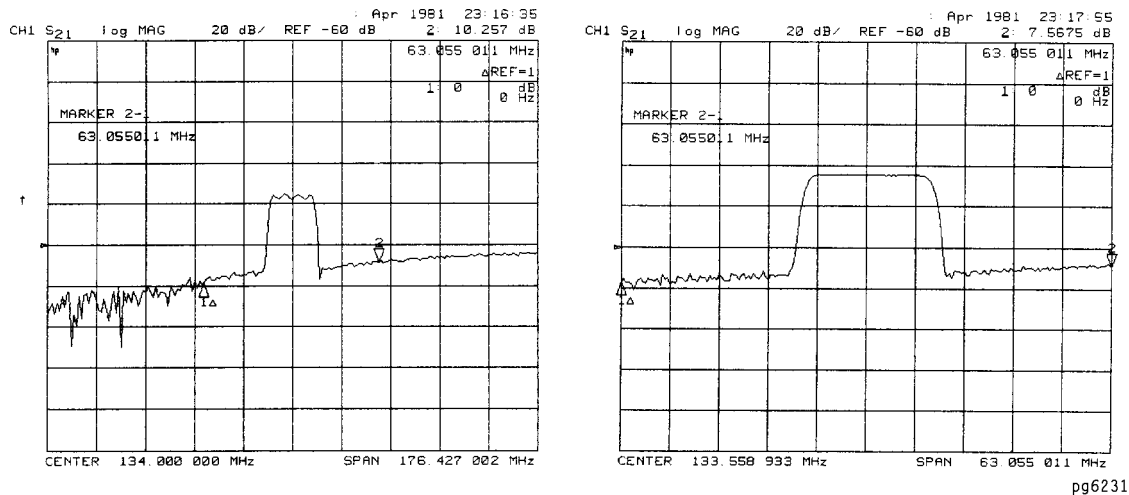
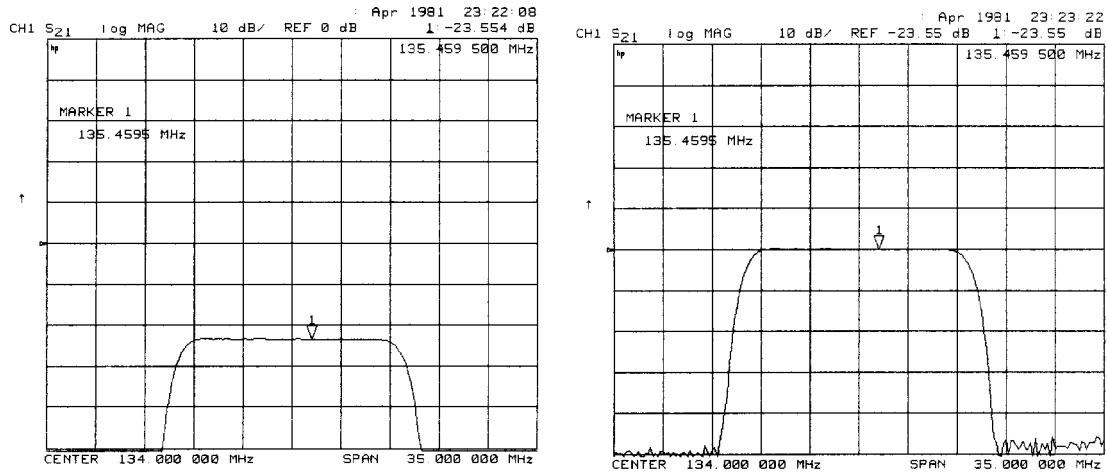

Figure 2-16. Example of Setting the Frequency Span Using Marker

Setting the Display Reference Value

1. Press **MARKER FCTN** and turn the front panel knob or enter a value from the front panel keypad to position the marker at the value that you want for the analyzer display reference value.
2. Press **MARKER→REFERENCE** to change the reference value to the value of the active marker.



pg6228

Figure 2-17. Example of Setting the Reference Value Using a Marker

Setting the Electrical Delay

This feature adds phase delay to a variation in phase versus frequency, therefore it is only applicable for ratioed inputs.

1. Press **FORMAT** **PHASE**.
2. Press **MARKER FCTN** and turn the front panel knob or enter a value from the front panel keypad to position the marker at a point of interest.
3. Press **MARKER**—**DELAY** to automatically add or subtract enough line length to the receiver input to compensate for the phase slope at the active marker position. This effectively flattens the phase trace around the active marker. You can use this to measure the electrical length or deviation from linear phase.

Additional electrical delay adjustments are required on devices without constant group delay over the measured frequency span.

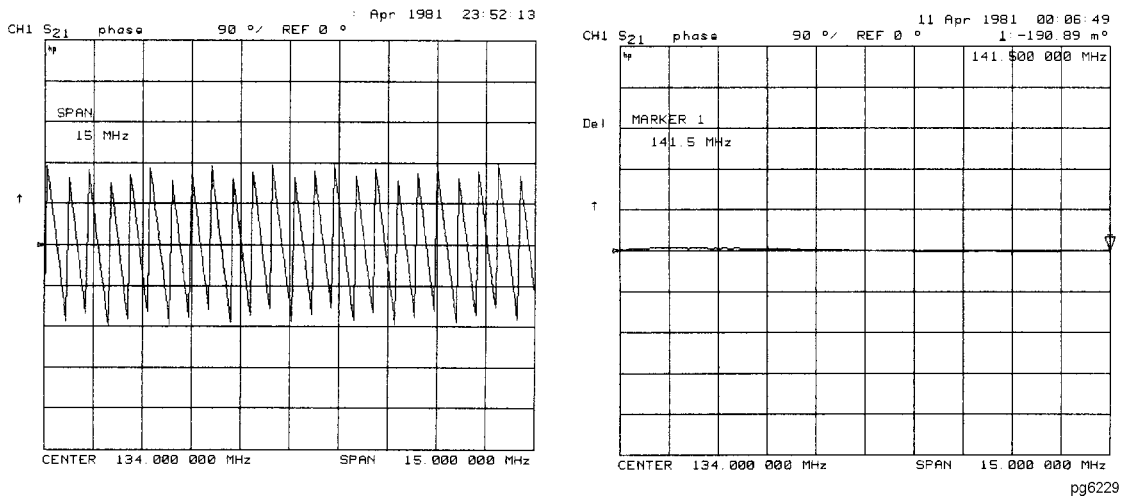

Figure 2-18. Example of Setting the Electrical Delay Using a Marker

Setting the CW Frequency

1. To place a marker at the desired CW frequency, press:
MARKER and either turn the front panel knob or enter the value, followed by **x1** **FRE**
2. Press **SEQ** **SPECIAL FUNCTIONS** **MKR**—**CW**.

You can use this function to set the marker to a gain peak in an amplifier. After pressing **MKR**—**CW** **FREQ**, activate a CW frequency power sweep to look at the gain compression with increasing input power.

To Search for a Specific Amplitude

These functions place the marker at an amplitude-related point on the trace. If you switch on tracking, the analyzer searches every new trace for the target point.

Searching for the Maximum Amplitude

1. Press **MARKER FCTN** **MKR SEARCH** to access the marker search menu.
2. Press **SEARCH: MAX** to move the active marker to the maximum point on the measurement trace.

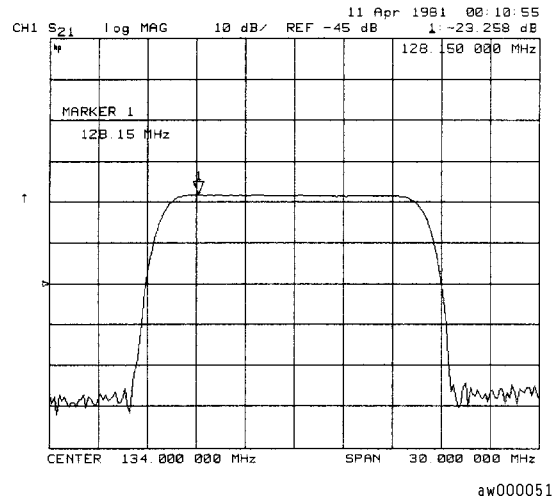

Figure 2-19.
Example of Searching for the Maximum Amplitude Using a Marker

Searching for the Minimum Amplitude

1. Press **MARKER FCTN** **MKR SEARCH** to access the marker search menu.
2. Press **SEARCH: MIN** to move the active marker to the minimum point on the measurement trace.

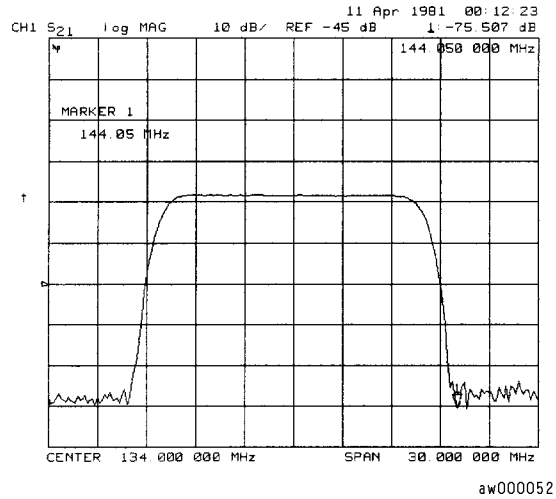

Figure 2-20.
Example of Searching for the Minimum Amplitude Using a Marker

Searching for a Target Amplitude

1. Press **MARKER FCTN** **MKR SEARCH** to access the marker search menu.
2. Press **SEARCH: TARGET** to move the active marker to the target point on the measurement trace.
3. If you want to change the target amplitude value (default is -3 dB), press **TARGET** and enter the new value from the front panel keypad.
4. If you want to search for multiple responses at the target amplitude value, press **SEARCH LEFT** and **SEARCH RIGHT**.

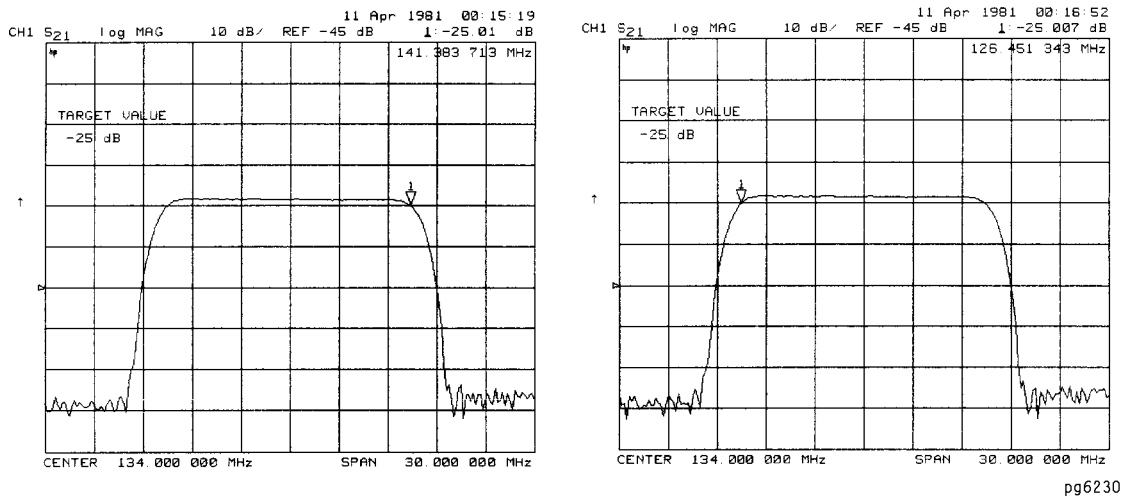

Figure 2-21.
Example of Searching for a Target Amplitude Using a Marker

Searching for a Bandwidth

The analyzer can automatically calculate and display the -3 dB bandwidth (BW:), center frequency (CENT:), Q, and loss of the device under test at the center frequency. (Q stands for “quality factor,” defined as the ratio of a circuit’s resonant frequency to its bandwidth.) These values are shown in the marker data readout.

1. Press **MARKER** and turn the front panel knob or enter a value from the front panel keypad to place the marker at the center of the filter passband.
2. Press **MKR ZERO** **MARKER FCTN** **MKR SEARCH** to access the marker search menu.
3. Press **WIDTHS ON** to calculate the center stimulus value, bandwidth, and the Q of a bandpass or band reject shape on the measurement trace.
4. If you want to change the amplitude value (default is -3 dB) that defines the passband or rejectband, press **WIDTH VALUE** and enter the new value from the front panel keypad.

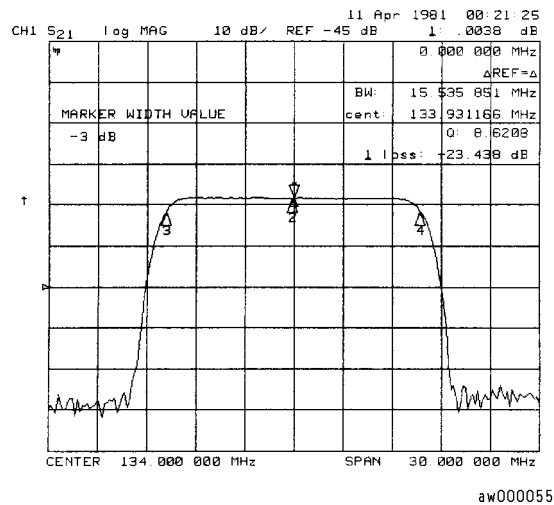

Figure 2-22. Example of Searching for a Bandwidth Using Markers

Tracking the Amplitude that You are Searching

1. Set up an amplitude search by following one of the previous procedures in “To Search for a Specific Amplitude.”
2. Press **MARKER FCTN** **MKR SEARCH** **TRACKING ON** to track the specified amplitude search with every new trace and put the active marker on that point.

When tracking is not activated, the analyzer finds the specified amplitude on the current sweep and the marker remains at same stimulus value, regardless of changes in the trace response value with subsequent sweeps.

To Calculate the Statistics of the Measurement Data

This function calculates the mean, standard deviation, and peak-to-peak values of the section of the displayed trace between the active marker and the delta reference. If there is no delta reference, the analyzer calculates the statistics for the entire trace.

1. Press **(MARKER) Δ MODE MENU Δ REF=1** to make marker 1 a reference marker.
2. Move marker 1 to any point that you want to reference:
 - Turn the front panel knob.
 OR
 - Enter the frequency value on the numeric keypad.
3. Press **MARKER 2** and move marker 2 to any position that you want to measure in reference to marker 1.
4. Press **(MARKER FCTN) MKR MODE MENU STATS ON** to calculate and view the mean, standard deviation, and peak-to-peak values of the section of the measurement data between the active marker and the delta reference marker.

An application for this feature is to find the peak-to-peak value of passband ripple without searching separately for the maximum and minimum values.

If you are viewing a measurement in the polar or Smith Chart format, the analyzer calculates the statistics using the first value of the complex pair (magnitude, real part, resistance, or conductance).

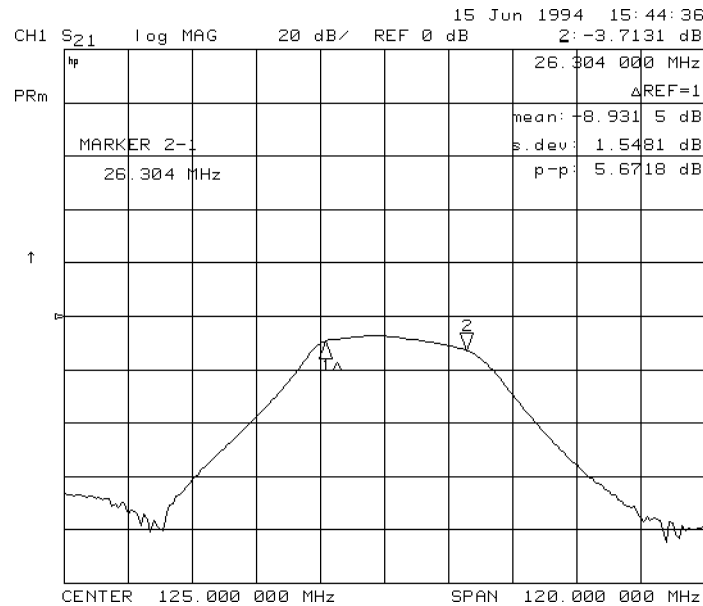

Figure 2-23. Example Statistics of Measurement Data

Measuring Magnitude and Insertion Phase Response

The analyzer allows you to make two different measurements simultaneously. You can make these measurements in different formats for the same parameter. For example, you could measure both the magnitude and phase of transmission. You could also measure two different parameters (S_{11} and S_{22}).

This measurement example shows you how to measure the maximum amplitude of a SAW filter and then how to view the measurement data in the phase format, which provides information about the phase response.

Measuring the Magnitude Response

1. Connect your test device as shown in Figure 2-24.

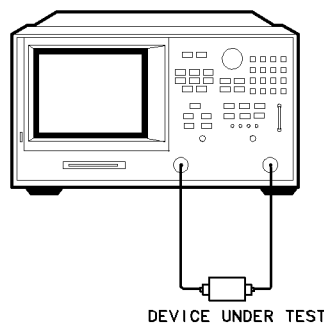

pg6110d

Figure 2-24. Device Connections for Measuring a Magnitude Response

2. Press **PRESET** and choose the measurement settings. For this example the measurement parameters are set as follows:

```
MEAS Trans: FWD S21 (B/R)
CENTER 134 M/μ
SPAN 50 M/μ
MENU POWER -3 x1
SCALE REF AUTO SCALE
CHAN 2
MEAS Trans: FWD S21 (B/R)
SCALE REF AUTO SCALE
```

You may also want to select settings for the number of data points, averaging, and IF bandwidth.

3. Substitute a thru for the device and perform a response calibration for both channel 1 and channel 2.

Press **CAL CALIBRATE MENU RESPONSE THRU**.

Press **CHAN 1 RESPONSE THRU**.

4. Reconnect your test device.

5. To better view the measurement trace, press:

SCALE REF **AUTO SCALE**

6. To locate the maximum amplitude of the device response, as shown in Figure 2-25, press:

MARKER FCTN **MKR SEARCH** **SEARCH: MAX**

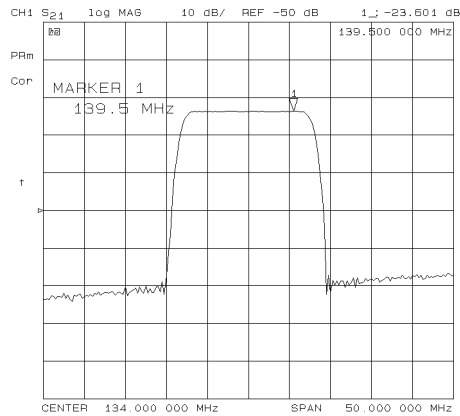

Figure 2-25. Example Magnitude Response Measurement Results

Measuring Insertion Phase Response

7. To view both the magnitude and phase response of the device, as shown in Figure 2-26, press:

CHAN 2

DISPLAY **DUAL CHAN ON**

FORMAT **PHASE**

The channel 2 portion of Figure 2-26 shows the insertion phase response of the device under test. The analyzer measures and displays phase over the range of -180° to $+180^\circ$. As phase changes beyond these values, a sharp 360° transition occurs in the displayed data.

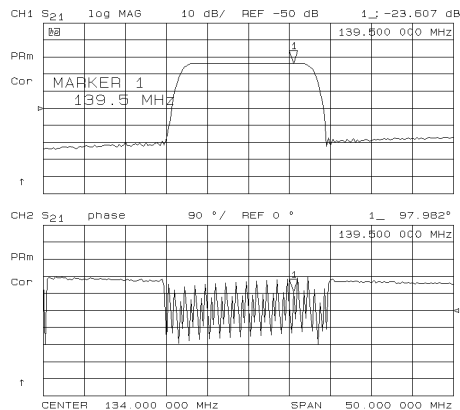
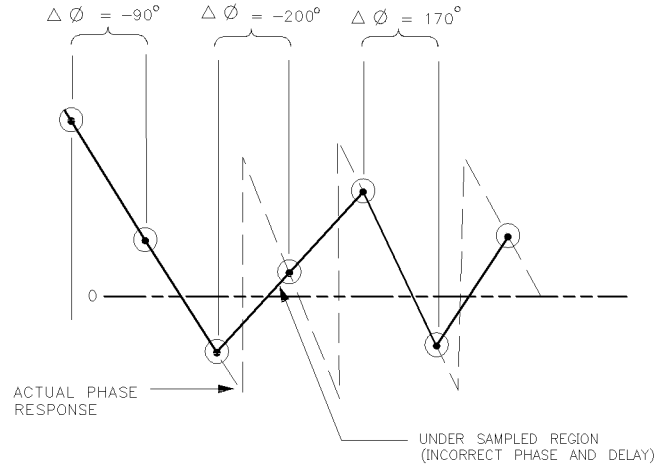

Figure 2-26. Example Insertion Phase Response Measurement

The phase response shown in Figure 2-27 is undersampled; that is, there is more than 180° phase delay between frequency points. If the $\Delta\phi = >180^\circ$, incorrect phase and delay information may result. Figure 2-27 shows an example of phase samples being with $\Delta\phi$ less than 180° and greater than 180° .



pb6125d

Figure 2-27. Phase Samples

Undersampling may arise when measuring devices with long electrical length. To correct this problem, the frequency span should be reduced, or the number of points increased until $\Delta\phi$ is less than 180° per point. Electrical delay may also be used to compensate for this effect (as shown in the next example procedure).

Measuring Electrical Length and Phase Distortion

Electrical Length

The analyzer mathematically implements a function similar to the mechanical “line stretchers” of earlier analyzers. This feature simulates a variable length lossless transmission line, which you can add to or remove from the analyzer’s receiver input to compensate for interconnecting cables, etc. In this example, the electronic line stretcher measures the electrical length of a SAW filter.

Phase Distortion

The analyzer allows you to measure the linearity of the phase shift through a device over a range of frequencies and the analyzer can express it in two different ways:

- deviation from linear phase
- group delay

Measuring Electrical Length

1. Connect your test device as shown in Figure 2-28.

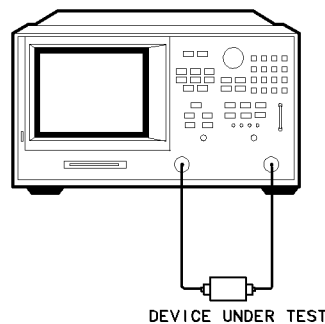

pg6110d

Figure 2-28. Device Connections for Measuring Electrical Length

2. Press **PRESET** and choose the measurement settings. For this example, the measurement settings include reducing the frequency span to eliminate under sampled phase response. Press the following keys as shown:

MEAS Trans: FWD S21 (B/R)

CENTER 134 (M/μ)

SPAN 2 (M/μ)

MENU POWER 5 (x1)

FORMAT PHASE

SCALE REF AUTO SCALE

You may also want to select settings for the number of data points, averaging, and IF bandwidth.

3. Substitute a thru for the device and perform a response calibration by pressing:

CAL **CALIBRATE MENU** **RESPONSE** **THRU**

4. Reconnect your test device.

5. To better view the measurement trace, press:

SCALE REF **AUTO SCALE**

Notice that in Figure 2-29 the SAW filter under test has considerable phase shift within only a 2 MHz span. Other filters may require a wider frequency span to see the effects of phase shift.

The linearly changing phase is due to the device's electrical length. You can measure this changing phase by adding electrical length (electrical delay) to compensate for it.



Figure 2-29. Linearly Changing Phase

6. To place a marker at the center of the band, press:

MARKER and turn the front panel knob or enter a value from the front panel keypad.

7. To activate the electrical delay function, press:

MARKER FCTN **MARKER**—**DELAY**

This function calculates and adds in the appropriate electrical delay by taking a $\pm 10\%$ span about the marker, measuring the $\Delta\phi$, and computing the delay as the negative of $\Delta\phi/\Delta\text{frequency}$.

- Press **(SCALE REF) ELECTRICAL DELAY** and turn the front panel knob to increase the electrical length until you achieve the best flat line, as shown in Figure 2-30.

The measurement value that the analyzer displays represents the electrical length of your device relative to the speed of light in free space. The physical length of your device is related to this value by the propagation velocity of its medium.

Note

Velocity factor is the ratio of the velocity of wave propagation in a coaxial cable to the velocity of wave propagation in free space. Most cables have a relative velocity of about 0.66 the speed in free space. This velocity depends on the relative permittivity of the cable dielectric (ϵ_r) as

$$VelocityFactor = \frac{1}{\sqrt{\epsilon_r}}$$

where ϵ_r is the relative permittivity of the cable dielectric

You could change the velocity factor to compensate for propagation velocity by pressing **(CAL) MORE VELOCITY FACTOR** (enter the value) **(X1)**. This will help the analyzer to accurately calculate the equivalent distance that corresponds to the entered electrical delay.

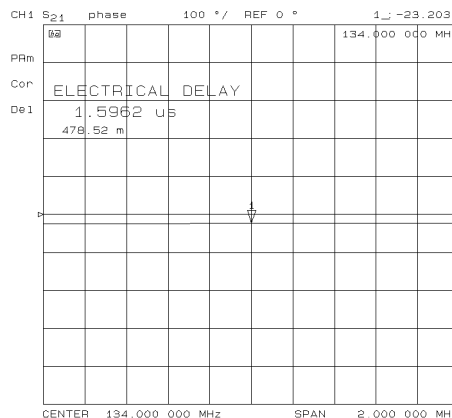

Figure 2-30. Example Best Flat Line with Added Electrical Delay

- To display the electrical length, press:

(SCALE REF) ELECTRICAL DELAY

In this example, there is a large amount of electrical delay due to the long electrical length of the SAW filter under test.

Measuring Phase Distortion

This portion of the example shows you how to measure the linearity of the phase shift over a range of frequencies. The analyzer allows you to measure this linearity and read it in two different ways: deviation from linear phase, or group delay.

Deviation From Linear Phase

By adding electrical length to “flatten out” the phase response, you have removed the linear phase shift through your device. The deviation from linear phase shift through your device is all that remains.

1. Follow the procedure in “Measuring Electrical Length.”
2. To increase the scale resolution, press:
SCALE REF SCALE DIV and turn the front panel knob or enter a value from the front panel keypad.
3. To use the marker statistics to measure the maximum peak-to-peak deviation from linear phase, press:
MARKER FCTN MKR MODE MENU STATS ON
4. Activate and adjust the electrical delay to obtain a minimum peak-to-peak value.

Note It is possible to use delta markers to measure peak-to-peak deviation in only one portion of the trace, see “To Calculate the Statistics of the Measurement Data” located earlier in this Chapter.

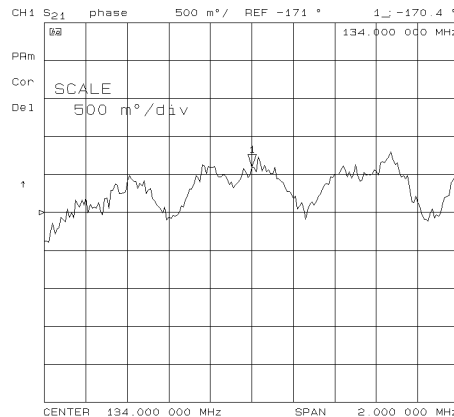

Figure 2-31. Deviation From Linear Phase Example Measurement

Group Delay

The phase linearity of many devices is specified in terms of group or envelope delay. The analyzer can translate this information into a related parameter, group delay. Group delay is the transmission time through your device under test as a function of frequency. Mathematically, it is the derivative of the phase response which can be approximated by the following ratio:

$$-\Delta\phi/(360 * \Delta F)$$

where $\Delta\phi$ is the difference in phase at two frequencies separated by ΔF . The quantity ΔF is commonly called the “aperture” of the measurement. The analyzer calculates group delay from its phase response measurements.

The default aperture is the total frequency span divided by the number of points across the display (i.e. 201 points or 0.5% of the total span in this example).

1. Continue with the same instrument settings and measurements as in the previous procedure, “Deviation from Linear Phase.”
2. To view the measurement in delay format, as shown in Figure 2-32, press:

FORMAT DELAY SCALE REF SCALE DIV ↑ ↑

- To activate a marker to measure the group delay at a particular frequency, press: **(MARKER)** and turn the front panel knob or enter a value from the front panel keypad.

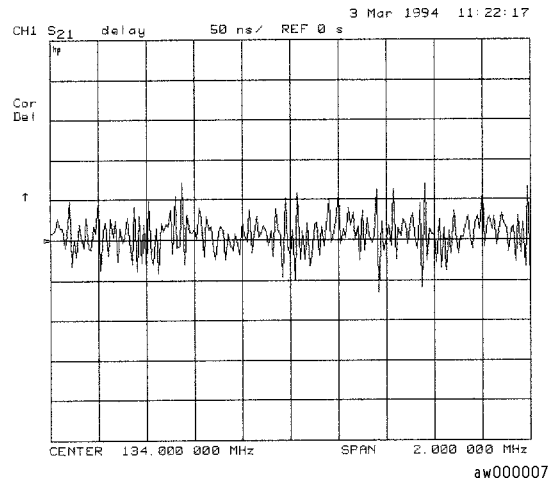

Figure 2-32. Group Delay Example Measurement

Group delay measurements may require a specific aperture (Δf) or frequency spacing between measurement points. The phase shift between two adjacent frequency points must be less than 180° , otherwise incorrect group delay information may result.

- To vary the effective group delay aperture from minimum aperture (no smoothing) to approximately 1% of the frequency span, press: **(AVG) SMOOTHING ON**.

When you increase the aperture, the analyzer removes fine grain variations from the response. It is critical that you specify the group delay aperture when you compare group delay measurements.

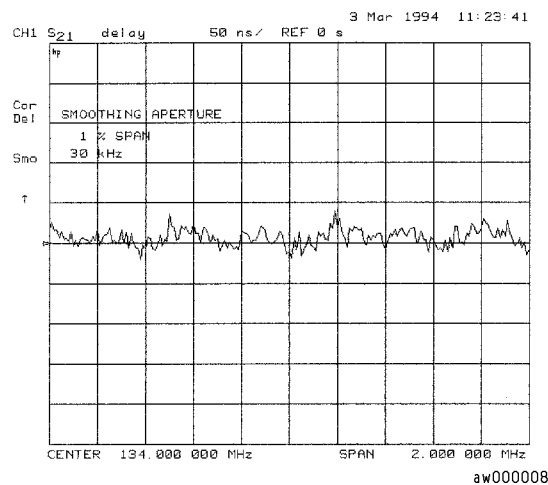

Figure 2-33. Group Delay Example Measurement with Smoothing

5. To increase the effective group delay aperture, by increasing the number of measurement points over which the analyzer calculates the group delay, press:

SMOOTHING APERTURE **5** **(x1)**

As the aperture is increased the “smoothness” of the trace improves markedly, but at the expense of measurement detail.

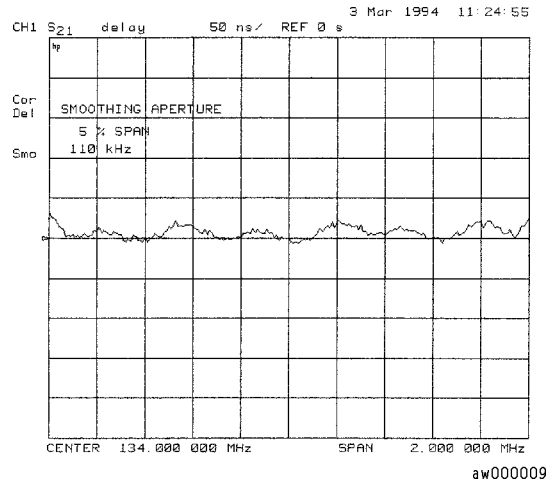

Figure 2-34.
Group Delay Example Measurement with Smoothing Aperture Increased

Testing A Device with Limit Lines

Limit testing is a measurement technique that compares measurement data to constraints that you define. Depending on the results of this comparison, the analyzer will indicate if your device either passes or fails the test.

Limit testing is implemented by creating individual flat, sloping, and single point limit lines on the analyzer display. When combined, these lines can represent the performance parameters for your device under test. The limit lines created on each measurement channel are independent of each other.

This example measurement shows you how to test a bandpass filter using the following procedures:

- creating flat limit lines
- creating sloping limit lines
- creating single point limit lines
- editing limit segments
- running a limit test

Setting Up the Measurement Parameters

1. Connect your test device as shown in Figure 2-35.

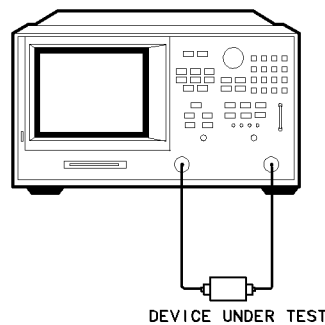

pg6110d

Figure 2-35. Connections for SAW Filter Example Measurement

2. Press **PRESET** and choose the measurement settings. For this example the measurement settings are as follows:

MEAS Trans: FWD S21 (B/R)
CENTER 134 **M/μ**
SPAN 50 **M/μ**
SCALE REF AUTO SCALE

You may also want to select settings for the number of data points, power, averaging, and IF bandwidth.

3. Substitute a thru for the device and perform a response calibration by pressing:

CAL CALIBRATE MENU RESPONSE THRU

4. Reconnect your test device.
5. To better view the measurement trace, press:

SCALE REF AUTO SCALE

Creating Flat Limit Lines

In this example procedure, the following flat limit line values are set:

Frequency Range	Power Range
127 MHz to 140 MHz	-27 dB to -21 dB
100 MHz to 123 MHz	-200 dB to -65 dB
146 MHz to 160 MHz	-200 dB to -65 dB

Note The minimum value for measured data is -200 dB.

1. To access the limits menu and activate the limit lines, press:

SYSTEM LIMIT MENU LIMIT LINE ON EDIT LIMIT LINE CLEAR LIST YES

2. To create a new limit line, press:

ADD

The analyzer generates a new segment that appears on the center of the display.

3. To specify the limit's stimulus value, test limits (upper and lower), and the limit type, press:

STIMULUS VALUE 127 M/μ

UPPER LIMIT -21 x1

LOWER LIMIT -27 x1

DONE

Note You could also set the upper and lower limits by using the MIDDLE VALUE and DELTA LIMITS keys. To use these keys for the entry, press:

MIDDLE VALUE -24 x1

DELTA LIMITS 3 x1

This would correspond to a test specification of -24 ± 3 dB.

4. To define the limit as a flat line, press:

LIMIT TYPE FLAT LINE RETURN

5. To terminate the flat line segment by establishing a single point limit, press:

```
ADD  
STIMULUS VALUE 140 (M/μ)  
DONE  
LIMIT TYPE SINGLE POINT RETURN
```

Figure 2-36 shows the flat limit lines that you have just created with the following parameters:

- stimulus from 127 MHz to 140 MHz
- upper limit of -21 dB
- lower limit of -27 dB

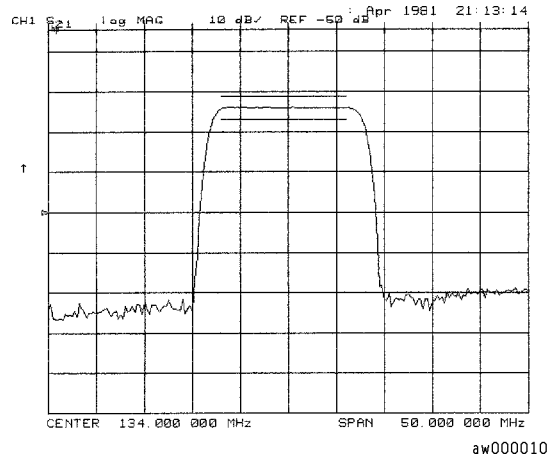

Figure 2-36. Example Flat Limit Line

6. To create a limit line that tests the low side of the filter, press:

```
ADD  
STIMULUS VALUE 100 (M/μ)  
UPPER LIMIT -65 (x1)  
LOWER LIMIT -200 (x1)  
DONE  
LIMIT TYPE FLAT LINE RETURN  
ADD  
STIMULUS VALUE 123 (M/μ)  
DONE  
LIMIT TYPE SINGLE POINT RETURN
```

7. To create a limit line that tests the high side of the bandpass filter, press:

```

ADD
STIMULUS VALUE (146) (M/μ)
UPPER LIMIT (-65) (x1)
LOWER LIMIT (-200) (x1)
DONE
LIMIT TYPE FLAT LINE RETURN
ADD
STIMULUS VALUE (160) (M/μ)
DONE
LIMIT TYPE SINGLE POINT RETURN
  
```

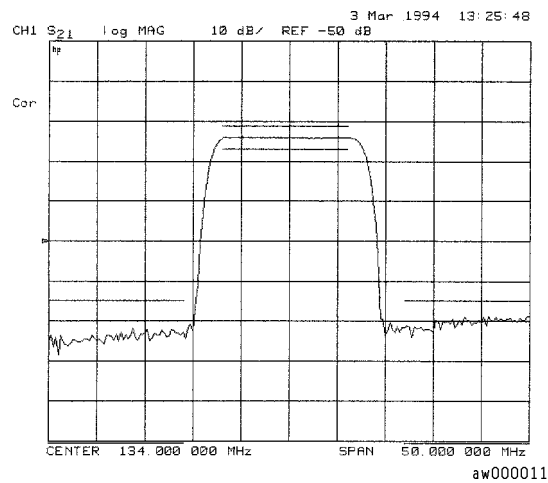

Figure 2-37. Example Flat Limit Lines

Creating a Sloping Limit Line

This example procedure shows you how to make limits that test the shape factor of a SAW filter. The following limits are set:

Frequency Range	Power Range
123 MHz to 125 MHz	-65 dB to -26 dB
144 MHz to 146 MHz	-26 dB to -65 dB

1. To access the limits menu and activate the limit lines, press:

```
(SYSTEM) LIMIT MENU LIMIT LINE ON EDIT LIMIT LINE CLEAR LIST YES
```

2. To establish the start frequency and limits for a sloping limit line that tests the low side of the filter, press:

```

ADD
STIMULUS VALUE (123) (M/μ)
UPPER LIMIT (-65) (x1)
LOWER LIMIT (-200) (x1)
DONE
LIMIT TYPE SLOPING LINE RETURN
  
```

- To terminate the lines and create a sloping limit line, press:

```

ADD
STIMULUS VALUE 125 (M/μ)
UPPER LIMIT -26 (x1)
LOWER LIMIT -200 (x1)
DONE
LIMIT TYPE SINGLE POINT RETURN

```

- To establish the start frequency and limits for a sloping limit line that tests the high side of the filter, press:

```

ADD
STIMULUS VALUE 144 (M/μ)
UPPER LIMIT -26 (x1)
LOWER LIMIT -200 (x1)
DONE
LIMIT TYPE SLOPING LINE RETURN

```

- To terminate the lines and create a sloping limit line, press:

```

ADD
STIMULUS VALUE 146 (M/μ)
UPPER LIMIT -65 (x1)
LOWER LIMIT -200 (x1)
DONE
LIMIT TYPE SINGLE POINT RETURN

```

You could use this type of limit to test the shape factor of a filter.

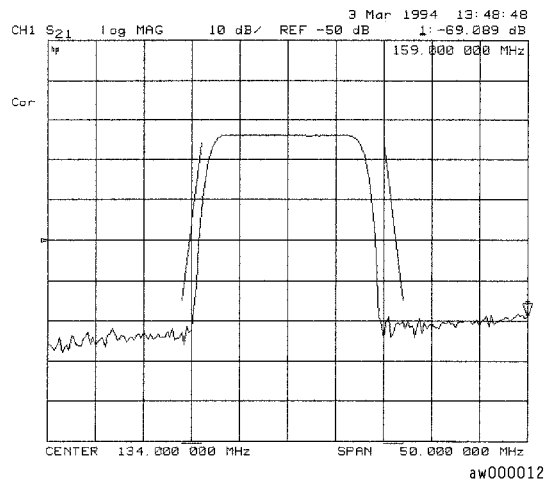

Figure 2-38. Sloping Limit Lines

Creating Single Point Limits

In this example procedure, the following limits are set:

- from -23 dB to -28.5 dB at 141 MHz
- from -23 dB to -28.5 dB at 126.5 MHz

1. To access the limits menu and activate the limit lines, press:

```
(SYSTEM) LIMIT MENU LIMIT LINE ON EDIT LIMIT LINE CLEAR LIST YES
```

2. To designate a single point limit line, as shown in Figure 2-39, you must define two pointers;

- downward pointing, indicating the upper test limit
- upward pointing, indicating the lower test limit

Press:

```
ADD
```

```
STIMULUS VALUE (141) (M/μ)
```

```
UPPER LIMIT (-23) (x1)
```

```
LOWER LIMIT (-28.5) (x1)
```

```
DONE
```

```
LIMIT TYPE SINGLE POINT
```

```
RETURN
```

```
ADD
```

```
STIMULUS VALUE (126.5) (M/μ)
```

```
UPPER LIMIT (-23) (x1)
```

```
LOWER LIMIT (-28.5) (x1)
```

```
DONE
```

```
LIMIT TYPE SINGLE POINT
```

```
RETURN
```

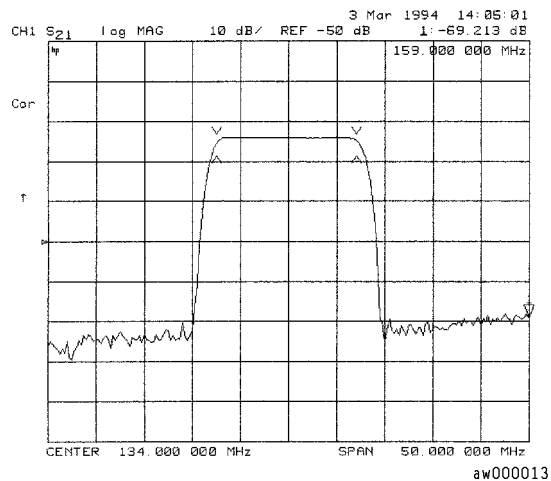

Figure 2-39. Example Single Points Limit Line

Editing Limit Segments

This example shows you how to edit the upper limit of a limit line.

1. To access the limits menu and activate the limit lines, press:

`(SYSTEM) LIMIT MENU LIMIT LINE ON EDIT LIMIT LINE`

2. To move the pointer symbol (>) on the analyzer display to the segment you wish to modify, press:

`SEGMENT` `(↑)` or `(↓)` repeatedly

OR

`SEGMENT` and enter the segment number followed by `(x1)`

3. To change the upper limit (for example, -20) of a limit line, press:

`EDIT UPPER LIMIT` `(-20)` `(x1)` `DONE`

Deleting Limit Segments

1. To access the limits menu and activate the limit lines, press:

`(SYSTEM) LIMIT MENU LIMIT LINE ON EDIT LIMIT LINE`

2. To move the pointer symbol (>) on the analyzer display to the segment you wish to delete, press:

`SEGMENT` `(↑)` or `(↓)` repeatedly

OR

`SEGMENT` and enter the segment number followed by `(x1)`

3. To delete the segment that you have selected with the pointer symbol, press:

`DELETE`

Running a Limit Test

1. To access the limits menu and activate the limit lines, press:

SYSTEM **LIMIT MENU** **LIMIT LINE ON** **EDIT LIMIT LINE**

Reviewing the Limit Line Segments

The limit table data that you have previously entered is shown on the analyzer display.

2. To verify that each segment in your limits table is correct, review the entries by pressing:

SEGMENT **↑** and **↓**

3. To modify an incorrect entry, refer to the “Editing Limit Segments” procedure, located earlier in this section.

Activating the Limit Test

4. To activate the limit test and the beep fail indicator, press:

SYSTEM **LIMIT MENU** **LIMIT TEST ON** **BEEP FAIL ON**

Note Selecting the beep fail indicator **BEEP FAIL ON** is optional and will add approximately 50 ms of sweep cycle time. Because the limit test will still work if the limits lines are off, selecting **LIMIT LINE ON** is also optional.

The limit test results appear on the right side on the analyzer display. The analyzer indicates whether the filter passes or fails the defined limit test:

- The message **FAIL** will appear on the right side of the display if the limit test fails.
- The analyzer beeps if the limit test fails and if **BEEP FAIL ON** has been selected.
- The analyzer alternates a red trace where the measurement trace is out of limits.
- A TTL signal on the rear panel BNC connector “LIMIT TEST” provides a pass/fail (5 V/0 V) indication of the limit test results.

Offsetting Limit Lines

The limit offset functions allow you to adjust the limit lines to the frequency and output level of your device. For example, you could apply the stimulus offset feature for testing tunable filters. Or, you could apply the amplitude offset feature for testing variable attenuators, or passband ripple in filters with variable loss.

This example shows you the offset feature and the limit test failure indications that can appear on the analyzer display.

1. To offset all of the segments in the limit table by a fixed frequency, (for example, 3 MHz), press:

```
SYSTEM
LIMIT MENU LIMIT LINE OFFSETS
STIMULUS OFFSET 3 M/μ
```

The analyzer beeps and a FAIL notation appears on the analyzer display, as shown in Figure 2-40.

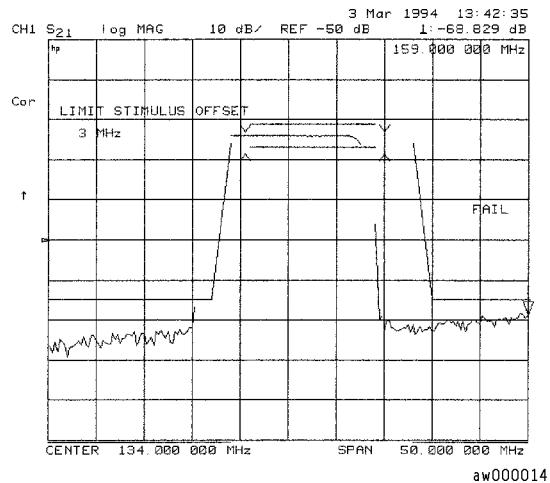

Figure 2-40. Example Stimulus Offset of Limit Lines

2. To return to 0 Hz offset, press:

```
STIMULUS OFFSET 0 x1
```

3. To offset all of the segments in the limit table by a fixed amplitude, press:

```
AMPLITUDE OFFSET 5 x1
```

The analyzer beeps and a FAIL notation appears on the analyzer display.

4. To return to 0 dB offset, press:

```
AMPLITUDE OFFSET 0 x1
```

Measuring Gain Compression

Gain compression occurs when the input power of an amplifier is increased to a level that reduces the gain of the amplifier and causes a nonlinear increase in output power. The point at which the gain is reduced by 1 dB is called the 1 dB compression point. The gain compression will vary with frequency, so it is necessary to find the worst case point of gain compression in the frequency band.

Once that point is identified, you can perform a power sweep of that CW frequency to measure the input power at which the 1 dB compression occurs and the absolute power out (in dBm) at compression. The following steps provide detailed instruction on how to apply various features of the analyzer to accomplish these measurements.

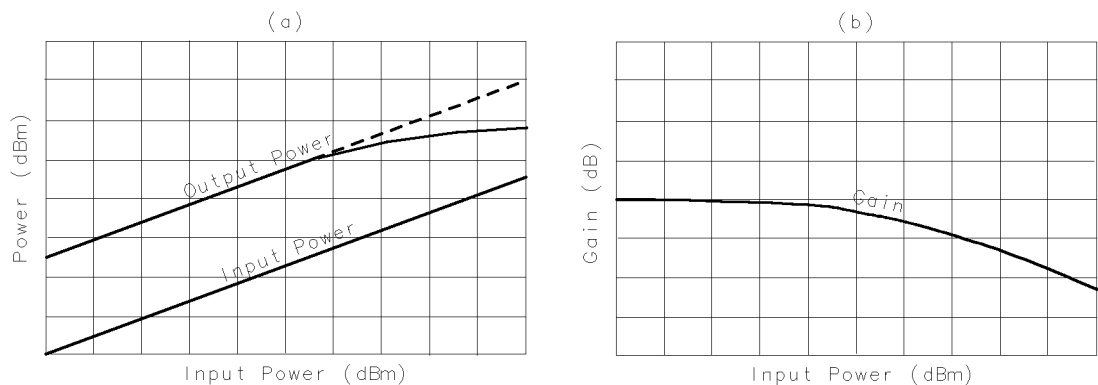

pb697d

Figure 2-41. Diagram of Gain Compression

1. Set up the stimulus and response parameters for your amplifier under test. To reduce the effect of noise on the trace, press:

AVG **IF BW 1000** **X1**

2. Perform the desired error correction procedure. Refer to Chapter 5, "Optimizing Measurement Results," for instructions on how to make a measurement correction.
3. Hook up the amplifier under test.
4. To produce a normalized trace that represents gain compression, perform either step 5 or step 6. (Step 5 uses trace math and step 6 uses uncoupled channels and the display function **D1/D2 to D2 ON**.)
5. Press **DISPLAY** **DATA** **→MEMORY** **DATA/MEM** to produce a normalized trace.
6. To produce a normalized trace, perform the following steps:
 - a. Press **DISPLAY** and select **DUAL CHANNEL ON** to view both channels simultaneously.

b. To uncouple the channel stimulus so that the channel power will be uncoupled, press:

(MENU) COUPLED CH OFF

This will allow you to separately increase the power for channel 2 and channel 1, so that you can observe the gain compression on channel 2 while channel 1 remains unchanged.

c. To display the ratio of channel 2 data to channel 1 data on the channel 2 display, press:

(CHAN 2) DISPLAY MORE D2/D1 to D2 ON

This produces a trace that represents gain compression only.

7. Press **(MARKER) MARKER 1** and position the marker at approximately mid-span.

8. Press **(SCALE REF) SCALE/DIV 1 (x1)** to change the scale to 1 dB per division.

9. Press **(MENU) POWER.**

10. Increase the power until you observe approximately 1 dB of compression on channel 2, using the step keys or the front panel knob.

11. To locate the worst case point on the trace, press:

(MARKER FCTN) MKR SEARCH SEARCH:MIN

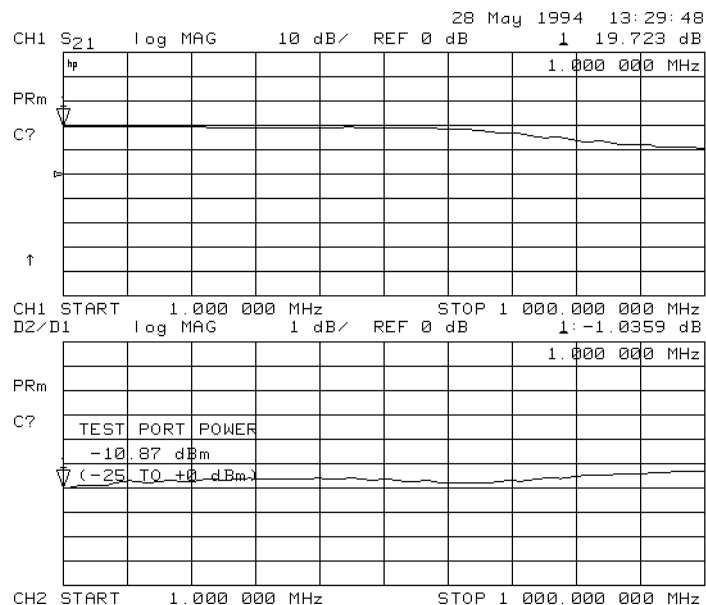

Figure 2-42. Gain Compression Using Linear Sweep and D2/D1 to D2 ON

12. If **COUPLED CH OFF** was selected, recouple the channel stimulus by pressing:

(MENU) COUPLED CH ON

13. To place the marker *exactly* on a measurement point, press:

(MARKER FCTN) MARKER MODE MENU MARKERS:DISCRETE

14. To set the CW frequency before going into the power sweep mode, press:

SEQ SPECIAL FUNCTIONS MARKER → CW

15. Press **MENU** SWEEP TYPE MENU POWER SWEEP .

16. Enter the start and stop power levels for the sweep.

Now channel 1 is displaying a gain compression curve. (Do not pay attention to channel 2 at this time.)

17. To maintain the calibration for the CW frequency, press:

CAL INTERPOL ON CORRECTION ON

18. Press **CHAN 2** **DISPLAY** DUAL CHANNEL ON .

19. If **D2/D1 to D2 ON** was selected, press **MORE** D2/D1 to D2 OFF .

20. Press **MEAS** INPUT PORTS B .

Now channel 2 displays absolute output power (in dBm) as a function of power input.

21. Press **SCALE REF** SCALE/DIV **10** **x1** to change the scale of channel 2 to 10 dB per division.

22. Press **CHAN 1** **1** **x1** to change the scale of channel 1 to 1 dB per division.

Note A receiver calibration will improve the accuracy of this measurement. Refer to Chapter 5, “Optimizing Measurement Results.”

23. Press **MARKER FCTN** MARKER MODE MENU MARKERS:COUPLED .

24. To find the 1 dB compression point on channel 1, press:

MARKER FCTN MKR SEARCH SEARCH:MAX

MARKER MKR ZERO

MARKER FCTN MKR SEARCH SEARCH:TARGET **-1** **x1**

Notice that the marker on channel 2 tracked the marker on channel 1.

25. Press **CHAN 2** **MARKER** MKR MODE MENU MARKERS:UNCOUPLED .

26. To take the channel 2 marker out of the Δ mode so that it reads the absolute output power of the amplifier (in dBm), press:

MARKER Δ MODE MENU Δ MODE OFF

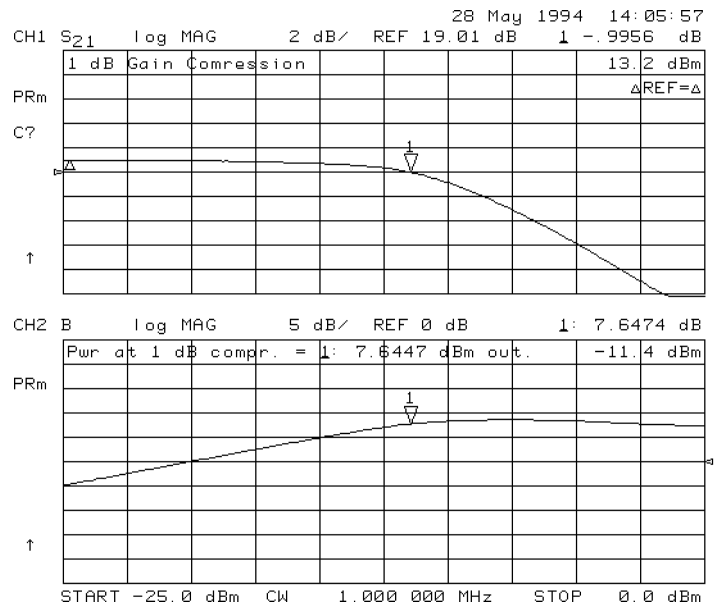

Figure 2-43. Gain Compression Using Power Sweep

Measuring Gain and Reverse Isolation Simultaneously

Since an amplifier will have high gain in the forward direction and high isolation in the reverse direction, the gain (S_{21}) will be much greater than the reverse isolation (S_{12}). Therefore, the power you apply to the input of the amplifier for the forward measurement (S_{21}) should be considerably lower than the power you apply to the output for the reverse measurement (S_{12}). By applying low power in the forward direction, you'll prevent the amplifier from being saturated. A higher power in the reverse direction keeps noise from being a factor in the measurement and accounts for any losses caused by attenuators or couplers on the amplifier's output needed to lower the output power into the analyzer. The following steps demonstrate the features that best accomplish these measurements.

1. Press **(MENU)** **COUPLED CH ON**.

Coupling the channels allows you to have the same frequency range and calibration applied to channel 1 and channel 2.

2. Press **POWER** **PORT POWER [UNCOUPLED]**.

Uncoupling the port power allows you to apply different power levels at each port. In Figure 2-44, the port 1 power is set to -25 dBm for the gain measurement (S_{21}) and the port 2 power is set to 0 dBm for the reverse isolation measurement (S_{12}).

3. Press **(CHAN 1)** **(MEAS)** **Trans: FWD S21 (B/R)** **(MENU)** **POWER** and set the power level for port 1.

4. Press **(CHAN 2)** **(MEAS)** **Trans: REV S12 (A/R)** **(MENU)** **POWER** and set the power level for port 2.

5. Perform an error-correction and connect the amplifier to the network analyzer. Refer to the "Optimizing Measurement Results" Chapter for error-correction procedures.

6. Press **(DISPLAY)** **DUAL CHAN ON**.

You can view both measurements simultaneously by using the dual channel display mode. Refer to Figure 2-44. If the port power levels are in different power ranges, one of the displayed measurements will not be continually updated and the annotation τsH will appear on the left side of the display. Refer to "Source Attenuator Switch Protection" section in Chapter 6, "Application and Operation Concepts," for information on how to override this state.

Note

To obtain best accuracy, you should set the power levels prior to performing the calibration. However, the analyzer compensates for nominal power changes you make during a measurement, so that the error correction still remains approximately valid. In these cases, the Cor annunciator will change to C?.

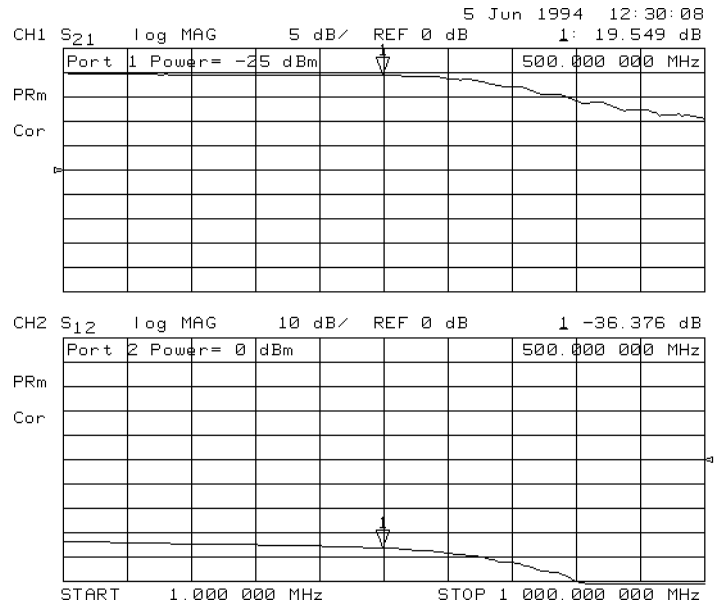

Figure 2-44. Gain and Reverse Isolation

Measurements Using the Tuned Receiver Mode

In the tuned receiver mode, the analyzer's receiver operates independently of any signal source. This mode is not phase-locked and functions in all sweep types. The analyzer tunes the receiver to a synthesized CW input signal at a precisely specified frequency. All phase lock routines are bypassed, increasing sweep speed significantly. The external source must be synthesized, and must drive the analyzer's external frequency reference. The analyzer's internal source frequency is not accurate, and the internal source should not be used in the tuned receiver mode.

Using the analyzer's tuned receiver mode is useful for automated test applications where an external synthesized source is available and applications where speed is important. Although the tuned receiver mode can function in all sweep types, it is typically used in CW applications.

Typical test setup

1. Activate the tuned receiver mode by pressing **(SYSTEM) INSTRUMENT MODE TUNED RECEIVER**.
2. Connect the equipment as shown in Figure 2-45 to perform a CW measurement using the tuned receiver mode.

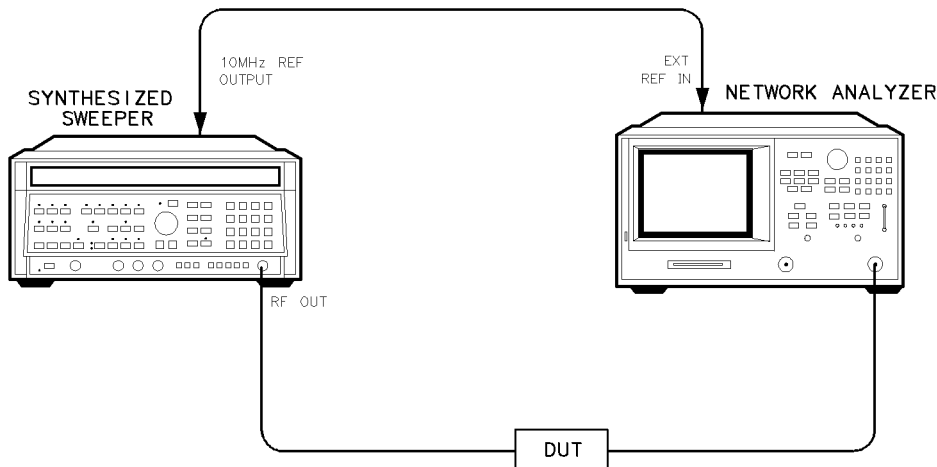

pg6153d

Figure 2-45. Typical Test Setup for Tuned Receiver Mode

Tuned receiver mode in-depth description

Frequency Range

30 kHz to 3 GHz (6 GHz for Option 006)

Compatible Sweep Types

All sweep types may be used.

External Source Requirements

An analyzer in tuned receiver mode can receive input signals into PORT 1, PORT 2, or R CHANNEL IN.

Input power range specifications are provided in Chapter 7, “Specifications and Measurement Uncertainties.”

Test Sequencing

Test sequencing allows you to automate repetitive tasks. As you make a measurement, the analyzer memorizes the keystrokes. Later you can repeat the entire sequence by pressing a single key. Because the sequence is defined with normal measurement keystrokes, you do not need additional programming expertise. Subroutines and limited decision-making increases the flexibility of test sequences. In addition, the GPIO outputs can be controlled in a test sequence, and the GPIO inputs can be tested in a sequence for conditional branching. For in-depth sequencing information, refer to “Test Sequencing” in Chapter 6, “Application and Operation Concepts.”

The test sequence function allows you to create, title, save, and execute up to six independent sequences internally.

You can also save sequences to disk and transfer them between the analyzer and an external computer controller.

The following procedures are based on an actual measurement example, that shows you how to do the following:

- create a sequence
- title a sequence
- edit a sequence
- clear a sequence
- change a sequence title
- name files generated by a sequence
- store a sequence
- load a sequence
- purge a sequence
- print a sequence

There are also three example sequences:

- cascading multiple sequences
- loop counter sequence
- limit test sequence

Creating a Sequence

1. To enter the sequence creation mode, press:

SEQ NEW SEQ/MODIFY SEQ

As shown in Figure 2-46, a list of instructions appear on the analyzer display to help you create or edit a sequence.

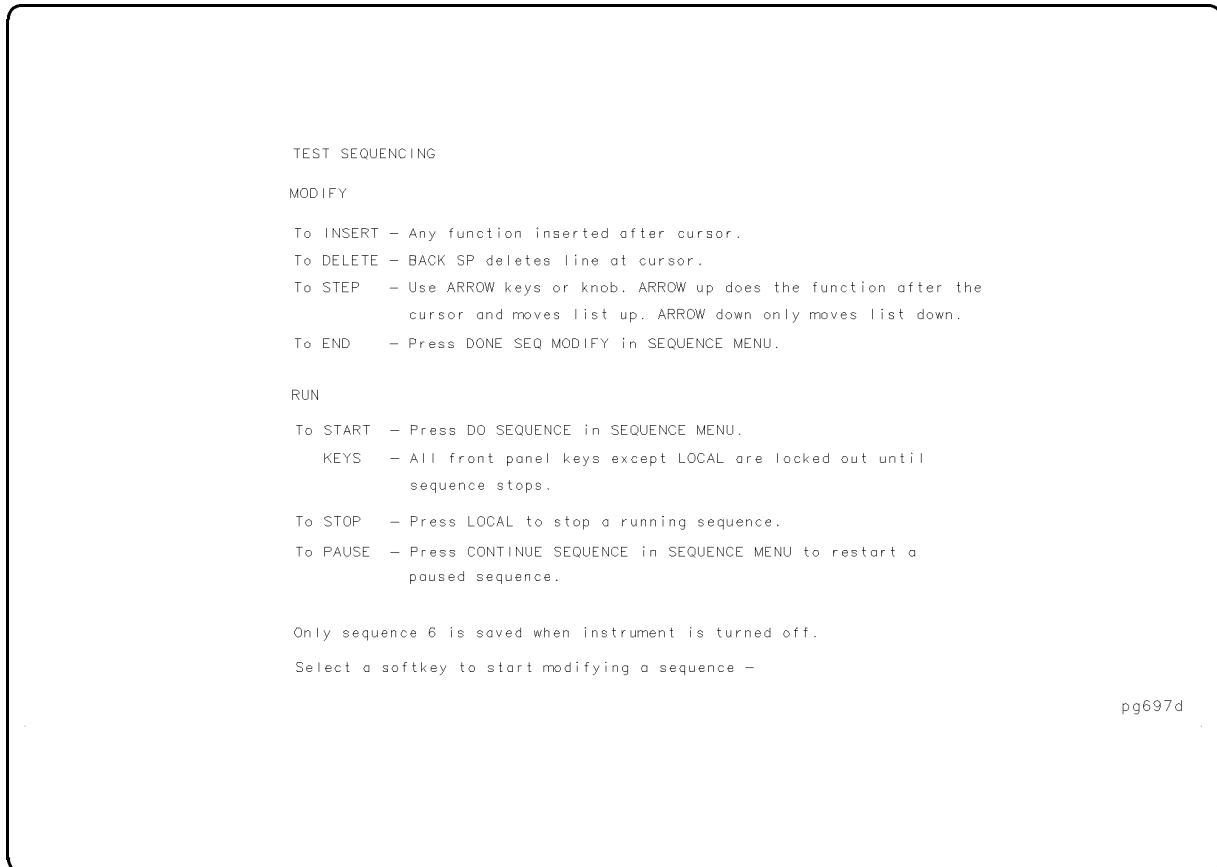

Figure 2-46. Test Sequencing Help Instructions

2. To select a sequence position in which to store your sequence, press:

SEQUENCE 1 SEQ1

This choice selects sequence position #1. The default title is SEQ1 for this sequence.

Refer to “Changing the Sequence Title,” (located later in this Chapter) for information on how to modify a sequence title.

3. To create a test sequence, enter the parameters for the measurement that you wish to make. For this example, a SAW filter measurement is set up with the following parameters:

SAVE/RECALL **SELECT DISK** **INTERNAL MEMORY**
RETURN **RECALL STATE**
MEAS **Trans: FWD S21 (B/R)**
FORMAT **LOG MAG**
CENTER **134** **M/μ**
SPAN **50** **M/μ**
SCALE REF **AUTOSCALE**

The above keystrokes will create a displayed list as shown:

```
Start of Sequence
RECALL PRST STATE
Trans: FWD S21 (B/R)
LOG MAG
CENTER
  134 M/u
SPAN
  50 M/u
SCALE/DIV
AUTO SCALE
```

4. To complete the sequence creation, press:

SEQ **DONE SEQ MODIFY**

Caution When you create a sequence, the analyzer stores it in volatile memory where it will be lost if you switch off the instrument power (except for sequence #6 which is stored in the analyzer non-volatile memory). However, you may store sequences to a floppy disk.

Running a Sequence

To run a stored test sequence, press:

PRESET and the softkey labeled with desired sequence number

or, press:

SEQ **DO SEQUENCE** and the softkey labeled with the desired sequence number.

Stopping a Sequence

To stop a sequence before it has finished, press **LOCAL**.

Editing a Sequence

Deleting Commands

1. To enter the creation/editing mode, press:

SEQ NEW SEQ/MODIFY SEQ

2. To select the particular test sequence you wish to modify (sequence 1 in this example), press:

SEQUENCE 1 SEQ1

3. To move the cursor to the command that you wish to delete, press:

⬆ or ⬇

- If you use the ⬆ key to move the cursor through the list of commands, the commands are actually performed when the cursor points to them. This feature allows the sequence to be tested one command at a time.
- If you wish to scroll through the sequence without executing each line as you do so, you can press the ⬇ key and scroll through the command list backwards.

4. To delete the selected command, press:

⬅ (backspace key)

5. Press **SEQ** DONE SEQ MODIFY to exit the modify (edit) mode.

Inserting a Command

1. To enter the creation/editing mode, press:

SEQ NEW SEQ/MODIFY SEQ

2. To select the particular test sequence you wish to modify (sequence 1 in this example), press:

SEQUENCE 1 SEQ1

3. To insert a command, move the cursor to the line immediately above the line where you want to insert a new command, by pressing:

⬆ or ⬇

- If you use the ⬆ key to move the cursor through the list of commands, the commands are actually performed when the cursor points to them. This feature allows the sequence to be tested one command at a time.
- If you wish to scroll through the sequence without executing each line as you do so, you can press the ⬇ key and scroll through the command list backwards.

4. To enter the new command, press the corresponding analyzer front panel keys. For example, if you want to activate the averaging function, press:

AVG AVERAGING ON

5. Press **SEQ** DONE SEQ MODIFY to exit the modify (edit) mode.

Modifying a Command

1. To enter the creation/editing mode, press:

PRESET **SEQ** NEW SEQ/MODIFY SEQ

2. To select the particular test sequence you wish to modify, (sequence 1 in this example), press:

SEQUENCE 1 SEQ1

The following list is the commands entered in “Creating a Sequence.” Notice that for longer sequences, only a portion of the list can appear on the screen at one time.

```
Start of Sequence
RECALL PRST STATE
Trans: FWD S21 (B/R)
LOG MAG
CENTER
  134 M/u
SPAN
  50 M/u
SCALE/DIV
AUTO SCALE
```

3. To change a command (for example, the span value from 50 MHz to 75 MHz) move the cursor (→) next to the command that you wish to modify, press:

↑ or **↓**

- If you use the **↑** key to move the cursor through the list of commands, the commands are actually performed when the cursor points to them. This feature allows the sequence to be tested one command at a time.
- If you wish to scroll through the sequence without executing each line as you do so, you can press the **↓** key and scroll through the command list backwards.

4. To delete the current command (for example, span value), press:

←

5. To insert a new value (for example, 75 MHz), press:

75 **M/μ**

6. Press **SEQ** DONE SEQ MODIFY to exit the modify (edit) mode.

Clearing a Sequence from Memory

1. To enter the menu where you can clear a sequence from memory, press:

SEQ MORE CLEAR SEQUENCE

2. To clear a sequence, press the softkey of the particular sequence.

Changing the Sequence Title

If you are storing sequences on a disk, you should replace the default titles (SEQ1, SEQ2 . . .).

1. To select a sequence that you want to retitle, press:

SEQ **MORE** **TITLE** **SEQUENCE** and select the particular sequence softkey.

The analyzer shows the available title characters. The current title is displayed in the upper-left corner of the screen.

2. You can create a new filename in two ways:

- If you have an attached DIN keyboard, you can press **f6** and then type the new filename.
- If you do not have an attached DIN keyboard, press **ERASE TITLE** and turn the front panel knob to point to the characters of the new filename, pressing **SELECT LETTER** as you stop at each character.

The analyzer cannot accept a title (file name) that is longer than eight characters. Your titles must also begin with a letter, and contain only letters and numbers.

3. To complete the titling, press **DONE**.

Naming Files Generated by a Sequence

The analyzer can automatically increment the name of a file that is generated by a sequence using a loop structure. (See example "Generating Files in a Loop Counter Example Sequence" later in this chapter.)

To access the sequence filename menu, press:

SAVE/RECALL

FILE UTILITIES

SEQUENCE FILENAMING

This menu presents two choices:

- **FILE NAME FILEO** supplies a name for the saved state and/or data file. This also brings up the Title File Menu.
- **PLOT NAME PLOTFILE** supplies a name for the plot file generated by a plot-to-disk command. This also brings up the Title File Menu.

The above keys show the current filename in the 2nd line of the softkey.

When titling a file for use in a loop function, you are restricted to only 2 characters in the filename due to the 6 character length of the loop counter keyword "[LOOP]." When the file is actually written, the [LOOP] keyword is expanded to only 5 ASCII characters (digits), resulting in a 7 character filename.

After entering the 2 character filename, press:

LOOP COUNTER **DONE**

Storing a Sequence on a Disk

1. To format a disk, refer to Chapter 4, “Printing, Plotting, and Saving Measurement Results.”
2. To save a sequence to the internal disk, press:

SEQ **MORE** **STORE SEQ TO DISK** and select the particular sequence softkey.

The disk drive access light should turn on briefly. When it goes out, the sequence has been saved.

Caution The analyzer will overwrite a file on the disk that has the same title.

Loading a Sequence from Disk

For this procedure to work, the desired file must exist on the disk in the analyzer drive.

1. To view the first six sequences on the disk, press:

SEQ **MORE** **LOAD SEQ FROM DISK** **READ SEQ FILE TITLS**

- If the desired sequence is not among the first six files, press:

READ SEQ FILE TITLS until the desired file name appears.

2. Press the softkey next to the title of the desired sequence. The disk access light should illuminate briefly.

Note If you know the title of the desired sequence, you can title the sequence (1-6) with the name, and load the sequence. This is also how you can control the sequence number of an imported titled sequence.

Purging a Sequence from Disk

1. To view the contents of the disk (six titles at a time), press:

SEQ **MORE** **STORE SEQ TO DISK** **PURGE SEQUENCES** **READ SEQ FILE TITLS**

- If the desired sequence is not among the first six files, press:

READ SEQ FILE TITLS until the desired file name appears.

2. Press the softkey next to the title of the desired sequence. The disk access light should illuminate briefly.

Printing a Sequence

1. Configure a compatible printer to the analyzer. (Refer to Chapter 11, “Compatible Peripherals.”)
2. To print a sequence, press:

SEQ **MORE** **PRINT SEQUENCE** and the softkey for the desired sequence.

Note If the sequence is on a disk, load the sequence (as described in a previous procedure) and then follow the printing sequence.

Cascading Multiple Example Sequences

By cascading test sequences, you can create subprograms for a larger test sequence. You can also cascade sequences to extend the length of test sequences to greater than 200 lines.

In this example, you are shown two sequences that have been cascaded. You can do this by having the last command in sequence 1 call sequence position 2, regardless of the sequence title. Because sequences are identified by position, not title, the call operation will always go to the sequence loaded into the given position.

1. To create the example multiple sequences, press:

```
(SEQ) NEW SEQ/MODIFY SEQ SEQUENCE 1 SEQ1
(CENTER) (134) (M/μ)
(SPAN) (50) (M/μ)
(SEQ) DO SEQUENCE SEQUENCE 2
DONE SEQ MODIFY
NEW SEQ/MODIFY SEQ SEQUENCE 2 SEQ2
(MEAS) Trans: FWD S21 (B/R)
(FORMAT) LOG MAG
(SCALE REF) AUTOSCALE
(SEQ) DONE SEQ MODIFY
```

The following sequences will be created:

SEQUENCE SEQ1

Start of Sequence

CENTER

134 M/u

SPAN

50 M/u

DO SEQUENCE

SEQUENCE 2

SEQUENCE SEQ2

Start of Sequence

Trans: FWD S21 (B/R)

LOG MAG

SCALE/DIV

AUTO SCALE

You can extend this process of calling the next sequence from the last line of the present sequence to 6 internal sequences, or an unlimited number of externally stored sequences.

2. To run both sequences, press:

```
(PRESET) SEQUENCE 1 SEQ1
```

Loop Counter Example Sequence

This example shows you the basic steps necessary for constructing a looping structure within a test sequence. A typical application of this loop counter structure is for repeating a specific measurement as you step through a series of CW frequencies or dc bias levels. For an example application, see “Fixed IF Mixer Measurements” in Chapter 3.

1. To create a sequence that will set the initial value of the loop counter, and call the sequence that you want to repeat, press:

```
(SEQ) NEW SEQ/MODIFY SEQ SEQUENCE 1 SEQ1
SPECIAL FUNCTIONS DECISION MAKING
LOOP COUNTER (10) (x1)
(SEQ) DO SEQUENCE SEQUENCE 2
DONE SEQ MODIFY
```

This will create a displayed list as shown:

SEQUENCE LOOP 1

```
Start of Sequence
LOOP COUNTER
  10x1
DO SEQUENCE
  SEQUENCE 2
```

To create a second sequence that will perform a desired measurement function, decrement the loop counter, and call itself until the loop counter value is equal to zero, press:

```
(SEQ) NEW SEQ/MODIFY SEQ SEQUENCE 2 SEQ2
(MEAS) Trans: FWD S21 (B/R)
(SCALE REF) AUTO SCALE
(MARKER FCTN) MKR SEARCH SEARCH: MAX
(SEQ) SPECIAL FUNCTIONS DECISION MAKING
DECR LOOP COUNTER IF LOOP COUNTER<> 0
SEQUENCE 2 SEQ2
(SEQ) DONE SEQ MODIFY
```

This will create a displayed list as shown:

SEQUENCE LOOP 2

```
Start of Sequence
Trans: FWD S21 (B/R)
SCALE/DIV
AUTO SCALE
MKR Fctn
SEARCH MAX
DECR LOOP COUNTER
IF LOOP COUNTER <> 0 THEN DO
  SEQUENCE 2
```

To run the loop sequence, press:

```
(PRESET) SEQUENCE 1 SEQ1
```

Generating Files in a Loop Counter Example Sequence

This example shows how to increment the names of files that are generated by a sequence with a loop structure.

```
(SEQ) NEW SEQ/MODIFY SEQ SEQUENCE 1 SEQ 1
SPECIAL FUNCTIONS DECISION MAKING
LOOP COUNTER (7) (x1)
(SAVE/RECALL) SELECT DISK INTERNAL DISK
RETURN DEFINE DISK-SAVE DATA ONLY ON
(LOCAL) SET ADDRESSES PLOTTER PORT DISK
(SEQ) DO SEQUENCE SEQUENCE 2
DONE SEQ MODIFY
NEW SEQ/MODIFY SEQ SEQUENCE 2 SEQ 2
(Save/Recall) FILE UTILITIES SEQUENCE FILE NAMING
FILE NAME FILEO ERASE TITLE
D T LOOP COUNTER DONE
PLOT NAME PLOTFILE ERASE TITLE
P L LOOP COUNTER DONE RETURN
(MENU) TRIGGER MENU SINGLE
(SAVE/RECALL) SAVE STATE
(COPY) PLOT
(SEQ) SPECIAL FUNCTIONS DECISION MAKING
DECR LOOP COUNTER IF LOOP COUNTER < > 0
SEQUENCE 2 SEQ 2
(SEQ) DONE SEQ MODIFY
```

This will create the following displayed lists:

```
Start of Sequence
LOOP COUNTER
  7 x1
INTERNAL DISK
DATA ONLY
ON
DO SEQUENCE
SEQUENCE 2
```



```

Start of Sequence
FILE NAME
  DT[LOOP]
PLOT NAME
  PL[LOOP]
SINGLE
SAVE FILE 0
PLOT
DECR LOOP COUNTER
IF LOOP COUNTER 0 THEN DO
  SEQUENCE 2

```

Sequence 1 initializes the loop counter and calls sequence 2. Sequence 2 repeats until the loop counter reaches 0. It takes a single sweep, saves the data file and plots the display.

- The data file names generated by this sequence will be:

```

DT00007.D1
through
DT000001.D1

```

- The plot file names generated by this sequence will be:

```

PL00007.FP
through
PL00001.FP

```

To run the sequence, press:

PRESET SEQUENCE 1 SEQ 1

Limit Test Example Sequence

This measurement example shows you how to create a sequence that will branch the sequence according to the outcome of a limit test. Refer to “Testing a Device with Limit Lines,” located earlier in this Chapter, for a procedure that shows you how to create a limit test.

For this example, you must have already saved the following in register 1:

- device measurement parameters
 - a series of active (visible) limit lines
 - an active limit test
1. To create a sequence that will recall the desired instrument state, perform a limit test, and branch to another sequence position based on the outcome of that limit test, press:

```

(SEQ) NEW SEQ MODIFY SEQUENCE 1 SEQ1
(SAVE/RECALL) RECALL KEYS MENU RECALL REG1
(SEQ) SPECIAL FUNCTIONS DECISION MAKING
IF LIMIT TEST PASS SEQUENCE 2 SEQ2
IF LIMIT TEST FAIL SEQUENCE 3 SEQ3
(SEQ) DONE SEQ MODIFY

```

This will create a displayed list for sequence 1, as shown:

```

Start of Sequence

```

```
RECALL REG 1
IF LIMIT TEST PASS THEN DO
SEQUENCE 2
IF LIMIT TEST FAIL THEN DO
SEQUENCE 3
```

2. To create a sequence that stores the measurement data for a device that has passed the limit test, press:

```
(SEQ) NEW SEQ MODIFY SEQUENCE 2 SEQ2
(SAVE/RECALL) SELECT DISK INTERNAL DISK RETURN
DEFINE DISK-SAVE DATA ARRAY ON RETURN SAVE STATE
(SEQ) DONE SEQ MODIFY
```

This will create a displayed list for sequence 2, as shown:

```
Start of Sequence
INTERNAL DISK
DATA ARRAY
ON
FILENAME
FILE 0
SAVE FILE
```

3. To create a sequence that prompts you to tune a device that has failed the limit test, and calls sequence 1 to retest the device, press:

```
(SEQ) NEW SEQ/MODIFY SEQ SEQUENCE 3 SEQ3
(DISPLAY) MORE TITLE
T U N E D E V I C E DONE
(SEQ) SPECIAL FUNCTIONS PAUSE RETURN
DO SEQUENCE SEQUENCE 1 SEQ1
(SEQ) DONE SEQ MODIFY
```

This will create a displayed list for sequence 3, as shown:

```
Start of Sequence
TITLE
TUNE DEVICE
SEQUENCE
PAUSE
DO SEQUENCE
SEQUENCE 1
```

Measuring Swept Harmonics

The analyzer has the unique capability of measuring swept second and third harmonics as a function of frequency in a real-time manner. Figure 2-47 displays the absolute power of the fundamental and second harmonic in dBm. Figure 2-48 shows the second harmonic's power level relative to the fundamental power in dBc. Follow the steps listed below to perform these measurements.

1. Press **CHAN 1** **MEAS** **Trans: FWD S21 (B/R)** **INPUT PORTS B** to measure the power for the fundamental frequencies.
2. Press **CHAN 2** **MEAS** **INPUT PORTS B** to measure the power for the harmonic frequencies.
3. Set the start frequency to a value greater than 16 MHz.
4. Press **MENU** and select **COUPLED CH OFF**. Uncoupling the channels allows you to have the separate sweeps necessary for measuring the fundamental and harmonic frequencies.
5. Press **POWER** and select **CHAN POWER [COUPLED]**. Coupling the channel power allows you to maintain the same fundamental frequency power level for both channels.
6. Press **MENU** **POWER** and set the power level for both channels.
7. Press **DISPLAY** and select **DUAL CHAN ON**.
8. Press **MARKER** and position marker to desired frequency.

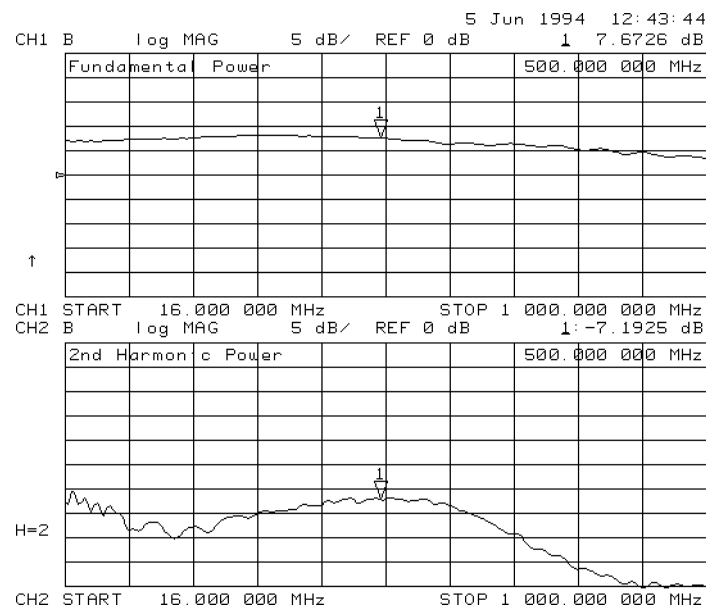

Figure 2-47. Fundamental and 2nd Harmonic Power Levels in dBm

Press **SYSTEM** **HARMONIC MEAS SECOND**. You can view both the fundamental power and harmonic power levels at the same time. (Refer to Figure 2-47.)

9. Press **CHAN 2** **DISPLAY** **MORE** and select **D2/D1 toD2 ON**. This display mode lets you see the relationship between the fundamental and second or third harmonic in dBc. (Refer to Figure 2-48.)

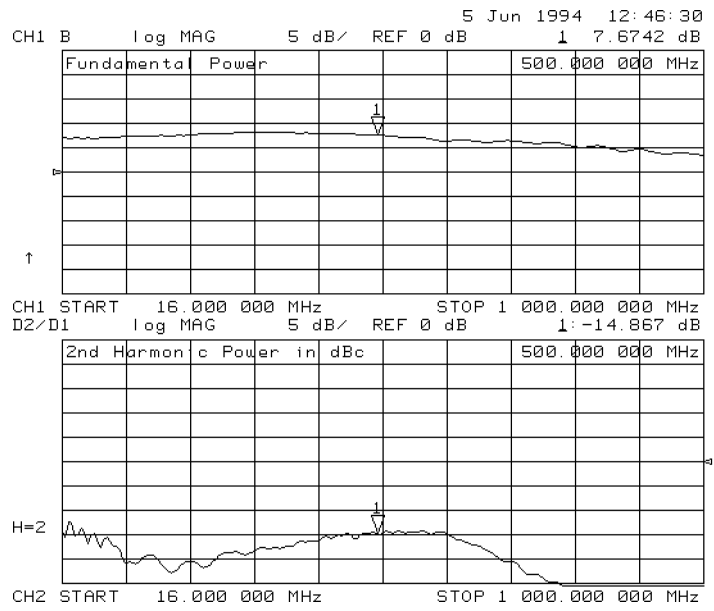

Figure 2-48. 2nd Harmonic Power Level in dBc

Measuring a Device in the Time Domain (Option 010 Only)

The HP 8753D Option 010 allows you to measure the time domain response of a device. Time domain analysis is useful for isolating a device problem in time or in distance. Time and distance are related by the velocity factor of your device under test. The analyzer measures the frequency response of your device and uses an inverse Fourier transform to convert the data to the time domain.

Gating

Time domain analysis allows you to mathematically remove individual parts of the time domain response to see the effect of potential design changes. You can accomplish this by “gating” out the undesirable responses.

This section shows you how to use the time domain function to measure a device response by the following measurement examples:

- transmission measurement of RF crosstalk and multi-path signal through a surface acoustic wave (SAW) filter
- reflection measurement that locates reflections along a terminated transmission line

Transmission Response in Time Domain

In this example measurement there are three components of the transmission response:

- RF leakage at near zero time
- the main travel path through the device ($1.6 \mu\text{s}$ travel time)
- the “triple travel” path ($4.8 \mu\text{s}$ travel time)

This example procedure also shows you how time domain analysis allows you to mathematically remove individual parts of the time domain response to see the effect of potential design changes. This is accomplished by “gating” out the undesirable responses. With the “gating” capability, the analyzer time domain allows you perform “what if” analysis by mathematically removing selected reflections and seeing the effect in the frequency domain.

1. Connect the device as shown in Figure 2-49.

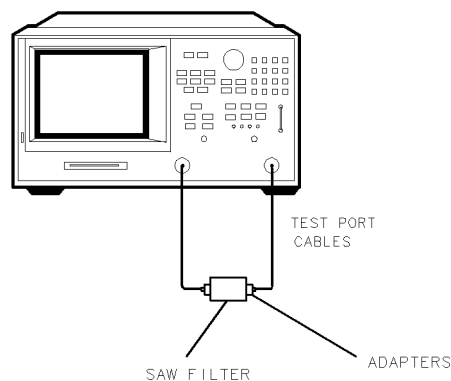

pg6112d

Figure 2-49. Device Connections for Time Domain Transmission Example Measurement

- To choose the measurement parameters, press:

```

(PRESET)
(MEAS) Trans:FWD S21 (B/R)
(START) (119) (M/μ)
(STOP) (149) (M/μ)
(SCALE REF) AUTO SCALE

```

- Substitute a thru for the device under test and perform a frequency response correction. Refer to “Calibrating the Analyzer,” located at the beginning of this Chapter, for a detailed procedure.
- Reconnect your device under test.
- To transform the data from the frequency domain to the time domain and set the sweep from 0 s to 6 μ s, press:

```

(SYSTEM) TRANSFORM MENU BANDPASS TRANSFORM ON
(START) (0) (G/n)
(STOP) (6) (M/μ)

```

The other time domain modes, low pass step and low pass impulse, are described in Chapter 6, “Application and Operation Concepts.”

- To better view the measurement trace, press:

```

(SCALE REF) REFERENCE VALUE

```

and turn the front panel knob or enter a value from the front panel keypad.

- To measure the peak response from the main path, press:

```

(MARKER FCTN) MKR SEARCH SEARCH: MAX

```

The three responses shown in Figure 2-50 are the RF leakage near zero seconds, the main travel path through the filter, and the triple travel path through the filter. Only the combination of these responses was evident to you in the frequency domain.

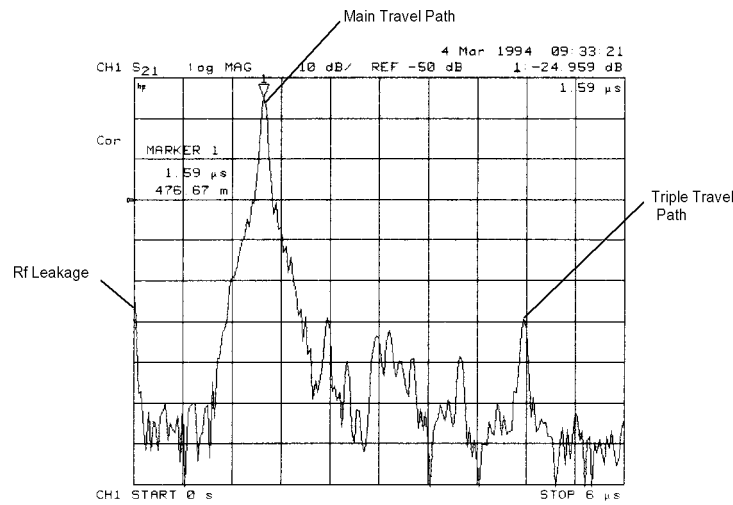

Figure 2-50. Time Domain Transmission Example Measurement

8. To access the gate function menu, press:

SYSTEM **TRANSFORM MENU** **SPECIFY GATE** **CENTER**

9. To set the gate parameters, by entering the marker value, press:

1.6 **(M/μ)**, or turn the front panel knob to position the “T” center gate marker.

10. To set the gate span, press:

SPAN **1.2** **(M/μ)** or turn the front panel knob to position the “flag” gate markers.

11. To activate the gating function to remove any unwanted responses, press:

GATE ON

As shown in Figure 2-51, only response from the main path is displayed.

Note You may remove the displayed response from inside the gate markers by pressing **SPAN** and turning the front panel knob to exchange the “flag” marker positions.

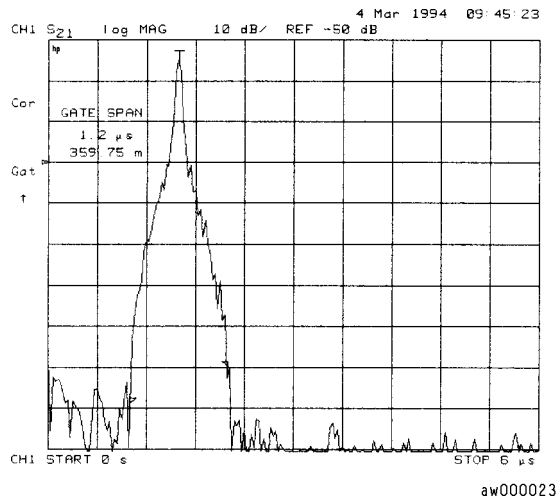

Figure 2-51.
Gating in a Time Domain Transmission Example Measurement

12. To adjust the gate shape for the best possible time domain response, press **GATE SHAPE** and select between minimum, normal, wide, and maximum. Each gate has a different passband flatness, cutoff rate, and sidelobe levels.

Table 2-2. Gate Characteristics

Gate Shape	Passband Ripple	Sidelobe Levels	Cutoff Time	Minimum Gate Span
Gate Span Minimum	±0.1 dB	-48 dB	1.4/Freq Span	2.8/Freq Span
Normal	±0.1 dB	-68 dB	2.8/Freq Span	5.6/Freq Span
Wide	±0.1 dB	-57 dB	4.4/Freq Span	8.8/Freq Span
Maximum	±0.01 dB	-70 dB	12.7/Freq Span	25.4/Freq Span

NOTE: With 1601 frequency points, gating is available only in the bandpass mode.

The passband ripple and sidelobe levels are descriptive of the gate shape. The cutoff time is the time between the stop time (-6 dB on the filter skirt) and the peak of the first sidelobe, and is equal on the left and right side skirts of the filter. Because the minimum gate span has no passband, it is just twice the cutoff time.

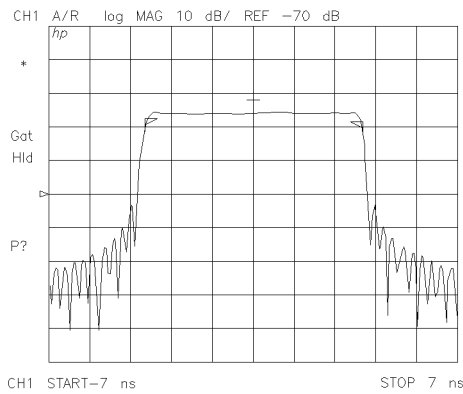

pg6121d

Figure 2-52. Gate Shape

13. To see the effect of the gating in the frequency domain, press:

(SYSTEM) TRANSFORM MENU TRANSFORM OFF

(SCALE REF) AUTO SCALE

(DISPLAY) DATA—MEM DISPLAY: DATA AND MEMORY

(SYSTEM) TRANSFORM MENU SPECIFY GATE GATE OFF

This places the gated response in memory. Figure 2-53 shows the effect of removing the RF leakage and the triple travel signal path using gating. By transforming back to the frequency domain we see that this design change would yield better out-of-band rejection.

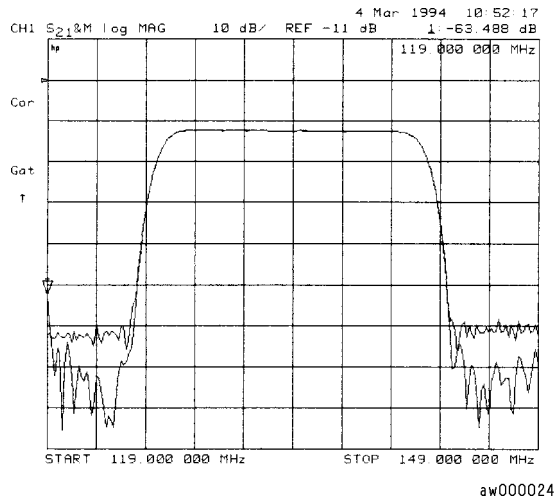

Figure 2-53.
Gating Effects in a Frequency Domain Example Measurement

Reflection Response in Time Domain

The time domain response of a reflection measurement is often compared with the time domain reflectometry (TDR) measurements. Like the TDR, the analyzer measures the size of the reflections versus time (or distance). Unlike the TDR, the time domain capability of the analyzer allows you to choose the frequency range over which you would like to make the measurement.

1. To choose the measurement parameters, press:

PRESET

MEAS Refl: FWD S11 (A/R)

START 50 M/μ

STOP 3 G/n

2. Perform an S_{11} 1-port correction on PORT 1. Refer to Chapter 5, “Optimizing Measurement Results,” for a detailed procedure.
3. Connect your device under test as shown in Figure 2-54.

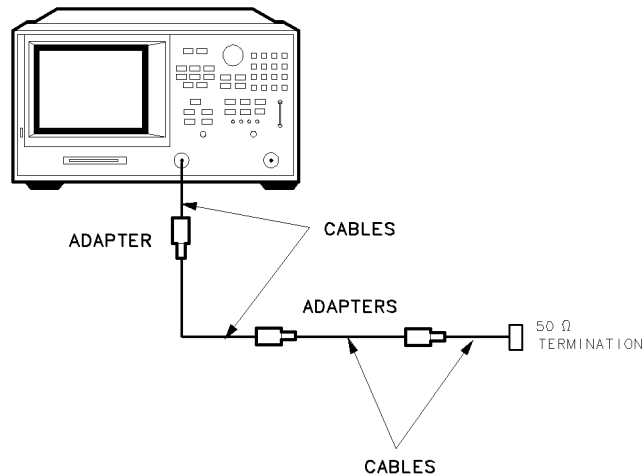

pg6115d

Figure 2-54. Device Connections for Reflection Time Domain Example Measurement

4. To better view the measurement trace, press:

SCALE REF **AUTO SCALE**

Figure 2-55 shows the frequency domain reflection response of the cables under test. The complex ripple pattern is caused by reflections from the adapters interacting with each other. By transforming this data to the time domain, you can determine the magnitude of the reflections versus distance along the cable.

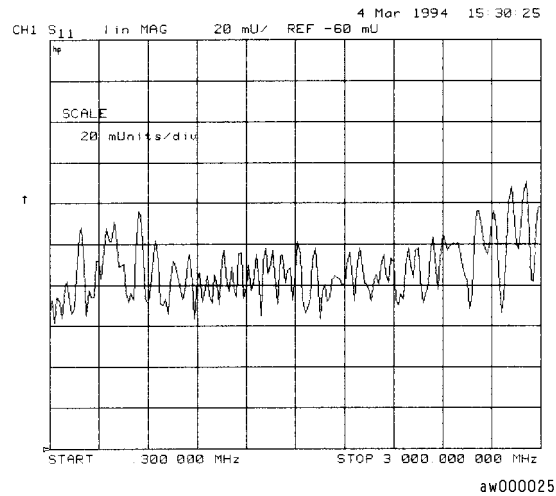

Figure 2-55. Device Response in the Frequency Domain

5. To transform the data from the frequency domain to the time domain, press:

SYSTEM **TRANSFORM MENU** **BANDPASS** **TRANSFORM ON**

6. To view the time domain over the length (<4 meters) of the cable under test, press:

FORMAT **LIN MAG**

START **0** **x1**

STOP **35** **G/n**

The stop time corresponds to the length of the cable under test. The energy travels about 1 foot per nanosecond, or 0.3 meter/ns, in free space. Most cables have a relative velocity of about 0.66 the speed in free space. Calculate about 3 ns/foot, or 10 ns/meter, for the stop time when you are measuring the return trip distance to the cable end.

7. To enter the relative velocity of the cable under test, press:

CAL **MORE** **VELOCITY FACTOR**

and enter a velocity factor for your cable under test.

Note

Most cables have a relative velocity of 0.66 (for polyethylene dielectrics) or 0.7 (for teflon dielectrics). If you would like the markers to read actual one-way distance rather than return trip distance, enter one-half the actual velocity factor. Then the markers will read the actual round trip distance to the reflection of interest rather than the “electrical length” that assumes a relative velocity of 1.

$$VelocityFactor = \frac{1}{\sqrt{\epsilon_r}}$$

where ϵ_r is the relative permittivity of the cable dielectric.

8. To position the marker on the reflection of interest, press:

MARKER

and turn the front panel knob or enter a value from the front panel keypad.

In this example, the velocity factor was set to one-half the actual value, so the marker reads the time and distance to the reflection.

9. To position a marker at each reflection of interest, as shown in Figure 2-56, press:

MARKER 2

MARKER 3

MARKER 4

, turning the front panel knob or entering a value from the front panel keypad after each key press.

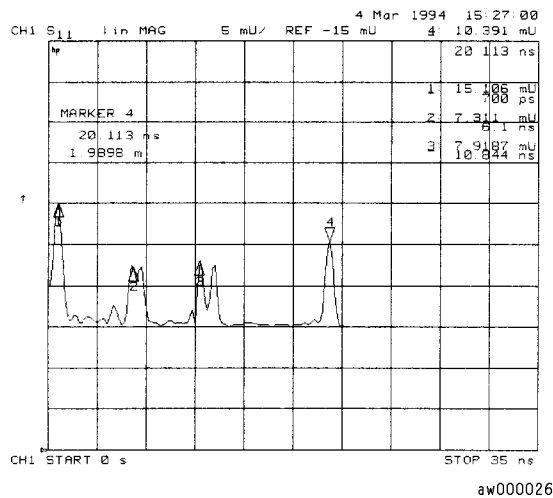

Figure 2-56. Device Response in the Time Domain

Non-coaxial Measurements

The capability of making non-coaxial measurements is available with the HP 8753 family of analyzers with TRL* (thru-reflect-line) or LRM* (line-reflect-match) calibration. For indepth information on TRL*/LRM* calibration, refer to Chapter 6, “Application and Operation Concepts.”

Non-coaxial, on-wafer measurements present a unique set of challenges for error correction in the analyzer:

- The close spacing between the microwave probes makes it difficult to maintain a high degree of isolation between the input and the output.
- The type of device measured on-wafer is often not always a simple two-port.
- It may be difficult to make repeatable on-wafer contacts due to the size of the device contact pads.

Due to the simplicity of the calibration standards, TRL* or LRM* calibrations may be used for non-coaxial applications such as on-wafer measurements. This type of calibration with time domain gating and a variety of probe styles can provide optimal accuracy in on-wafer measurements. At frequencies where on-wafer calibration standards are available, SOLT calibrations can also be done and may be preferred due to the better accuracy of the SOLT calibration method.

For information on how to perform TRL* or LRM* calibrations, refer to the section “TRL* and TRM* Error-Correction” in Chapter 5, “Optimizing Measurement Results.”

Making Mixer Measurements

This chapter contains information and example procedures on the following topics:

- Measurement considerations
 - Minimizing Source and Load Mismatches
 - Reducing the Effect of Spurious Responses
 - Eliminating Unwanted Mixing and Leakage Signals
 - How RF and IF Are Defined
 - Frequency Offset Mode Operation
 - Differences Between Internal and External R-Channel Inputs
 - Power Meter Calibration
- Conversion loss using the frequency offset mode
- High dynamic range swept RF/IF conversion loss
- Fixed IF measurements
- Group delay measurements
- Conversion compression using the frequency offset mode
- Isolation
 - LO to RF isolation
 - RF feedthrough

Where to Look for More Information

Additional information about many of the topics discussed in this chapter is located in the following areas:

- Chapter 2, “Making Measurements,” contains step-by-step procedures for making measurements or using particular functions.
- Chapter 4, “Printing, Plotting, and Saving Measurement Results,” contains instructions for saving to disk or the analyzer internal memory, and printing and plotting displayed measurements.
- Chapter 5, “Optimizing Measurement Results,” describes techniques and functions for achieving the best measurement results.
- Chapter 6, “Application and Operation Concepts,” contains explanatory-style information about many applications and analyzer operation.

Measurement Considerations

To ensure successful mixer measurements, the following measurement challenges must be taken into consideration:

- Mixer Considerations
 - Minimizing Source and Load Mismatches
 - Reducing the Effect of Spurious Responses
 - Eliminating Unwanted Mixing and Leakage Signals
- Analyzer Operation
 - How RF and IF Are Defined
 - Frequency Offset Mode Operation
 - Differences Between Internal and External R-Channel Inputs
 - Power Meter Calibration

Minimizing Source and Load Mismatches

When characterizing linear devices, you can use vector accuracy enhancement to mathematically remove all systematic errors, including source and load mismatches, from your measurement. This is not possible when the device you are characterizing is a mixer operating over multiple frequency ranges. Therefore, source and load mismatches are not corrected for and will add to overall measurement uncertainty.

You should place attenuators at all of the test ports to reduce the measurement errors associated with the interaction between mixer port matches and system port matches. To avoid overdriving the receiver, you should give extra care to selecting the attenuator located at the mixer's IF port. For best results, you should choose the attenuator value so that the power incident on the analyzer R-channel input is less than -10 dBm and greater than -35 dBm.

Reducing the Effect of Spurious Responses

By choosing test frequencies (frequency list mode), you can reduce the effect of spurious responses on measurements by avoiding frequencies that produce IF signal path distortion.

Eliminating Unwanted Mixing and Leakage Signals

By placing filters between the mixer's IF port and the receiver's input port, you can eliminate unwanted mixing and leakage signals from entering the analyzer's receiver. Filtering is required in both fixed and broadband measurements. Therefore, when configuring broad-band (swept) measurements you may need to trade some measurement bandwidth for the ability to more selectively filter signals entering the analyzer receiver.

How RF and IF Are Defined

In standard mixer measurements, the input of the mixer is always connected to the analyzer's RF source, and the output of the mixer always produces the IF frequencies that are received by the analyzer's receiver.

However, the ports labeled RF and IF on most mixers are not consistently connected to the analyzer's source and receiver ports, respectively. These mixer ports are switched, depending on whether a down converter or an up converter measurement is being performed.

It is important to keep in mind that in the setup diagrams of the frequency offset mode, the analyzer's source and receiver ports are labeled according to the mixer port that they are connected to.

- In a down converter measurement where the **DOWN CONVERTER** softkey is selected, the notation on the analyzer's setup diagram indicates that the analyzer's source frequency is labeled RF, connecting to the mixer RF port, and the analyzer's receiver frequency is labeled IF, connecting to the mixer IF port.

Because the RF frequency can be greater or less than the set LO frequency in this type of measurement, you can select either **RF > LO** or **RF < LO**.

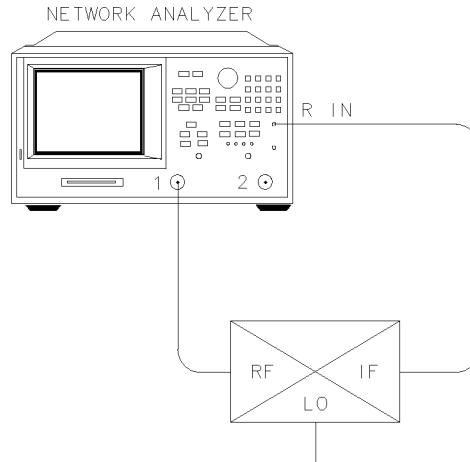

pg6243d

Figure 3-1. Down Converter Port Connections

- In an up converter measurement where the **UP CONVERTER** softkey is selected, the notation on the setup diagram indicates that the analyzer's source frequency is labeled IF, connecting to the mixer IF port, and the analyzer's receiver frequency is labeled RF, connecting to the mixer RF port.

Because the RF frequency will always be greater than the set LO frequency in this type of measurement, you *must select only* **RF > LO**.

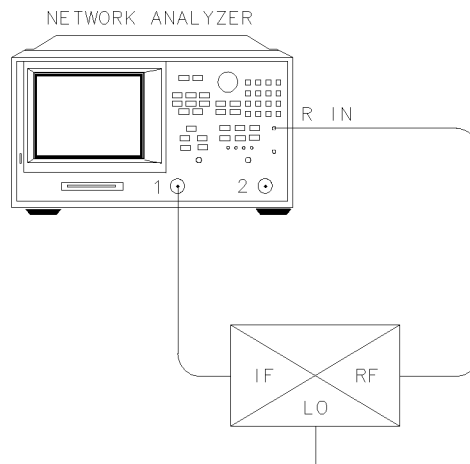

pg6244d

Figure 3-2. Up Converter Port Connections

Frequency Offset Mode Operation

Frequency offset measurements do not begin until all of the frequency offset mode parameters are set. These include the following:

- Start and Stop IF Frequencies
- LO frequency
- Up Converter / Down Converter
- $RF > LO$ / $RF < LO$

The LO frequency for frequency offset mode must be set to the same value as the external LO source. The offset frequency between the analyzer source and receiver will be set to this value.

When frequency offset mode operation begins, the receiver locks onto the entered IF signal frequencies and then offsets the source frequency required to produce the IF. Therefore, since it is the analyzer receiver that controls the source, it is only necessary to set the start and stop frequencies from the receiver.

Differences Between Internal and External R-Channel Inputs

Due to internal losses in the analyzer's test set, the power measured internally at the R-Channel is 16 dB lower than that of the source. To compensate for these losses, the traces associated with the R-Channel have been offset 16 dB higher. As a result, power measured *directly* at the R-Channel via the R CHANNEL IN port will appear to be 16 dB higher than its actual value. If power meter calibration is not used, this offset in power must be accounted for with a receiver calibration before performing measurements.

The following steps can be performed to observe this offset in power:

1. To set the power range to manual, press:

```
MENU
POWER
PWR RANGE MAN 0 x1
```

Setting the power range to manual prevents the internal source attenuator from switching when changing power levels. If you choose a different power range, the R-channel offset compensation and R-channel measurement changes by the amount of the attenuator setting.

2. Connect the analyzer source output, port 1, directly to the R-channel input as shown in Figure 3-3.

Caution To prevent connector damage, use an adapter (HP part number 1250-1462) as a connector saver for R CHANNEL IN.

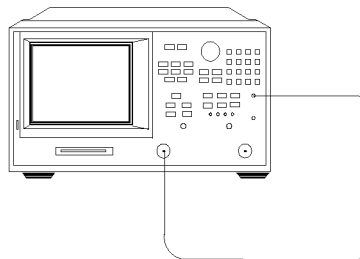

pg6241d

Figure 3-3. R-Channel External Connection

3. To activate the frequency offset mode, press:

SYSTEM
INSTRUMENT MODE
FREQ OFFS MENU
FREQ OFFS ON

Since the LO (offset) frequency is still set to the default value of 0 Hz, the analyzer will operate normally.

4. Measure the output power in the R-channel by pressing:

MEAS
INPUT PORTS
R

Observe the 13 to 16 dB offset in measured power. The actual input power level to the R-channel input must be 0 dBm or less, -10 dBm typical, to avoid receiver saturation effects. The minimum signal level must be greater than -35 dBm to provide sufficient signal for operation of the phaselock loop.

5. You cannot trust R channel power settings without knowing about the offset involved. Perform a receiver calibration to remove any power offsets by pressing:

CAL
RECEIVER CAL
TAKE RCVR CAL SWEEP

Once completed, the R-channel should display 0 dBm. Changing power ranges will require a recalibration of the R-channel.

Power Meter Calibration

Mixer transmission measurements are generally configured as follows:

$$\text{measured output power (Watts)} / \text{set input power (Watts)}$$

OR

$$\text{measured output power (dBm)} - \text{set input power (dBm)}$$

For this reason, the set input power must be accurately controlled in order to ensure measurement accuracy.

The amplitude variation of the analyzer is specified ± 1 dB over any given source frequency. This may give a maximum 2 dB error for a mixer transmission test setup: ± 1 dB for the source over the IF range during measurement and ± 1 dB over the RF range during measurement.

Higher measurement accuracy may be obtained through the use of power meter calibration. You can use power meter calibration to correct for power offsets, losses, and flatness variations occurring between the analyzer source and the input to the mixer under test.

Conversion Loss Using the Frequency Offset Mode

Conversion loss is the measure of efficiency of a mixer. It is the ratio of side-band IF power to RF signal power, and is usually expressed in dB. (Express ratio values in dB amounts to a subtraction of the dB power in the denominator from the dB power in the numerator.) The mixer translates the incoming signal, (RF), to a replica, (IF), displaced in frequency by the local oscillator, (LO). Frequency translation is characterized by a loss in signal amplitude and the generation of additional sidebands. For a given translation, two equal output signals are expected, a lower sideband and an upper sideband.

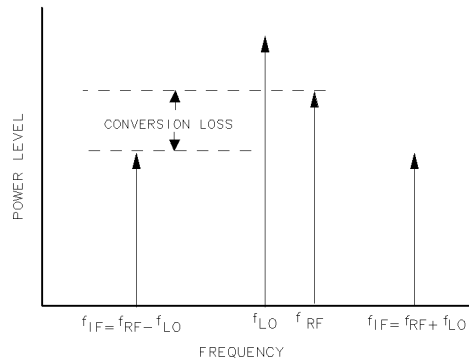

pg694d

Figure 3-4.
An Example Spectrum of RF, LO, and IF Signals Present in a Conversion Loss Measurement

The analyzer allows you to make a swept RF/IF conversion loss measurement holding the LO frequency fixed. You can make this measurement by using the analyzer's frequency offset measurement mode. This mode of operation allows you to offset the analyzer's source by a fixed value, above or below the analyzer's receiver. That is, this allows you to use a device input frequency range that is different from the receiver input frequency range.

The following procedure describes the swept IF frequency conversion loss measurement of a broadband component mixer:

1. Set the LO source to the desired CW frequency and power level.

CW frequency = 1000 MHz

Power = 13 dBm

2. Set the desired source power to the value which will provide -10 dBm or less to the R-channel input. Press:

(MENU)

POWER PWR RANGE MAN **(0)** **(x1)**

3. Calibrate and zero the power meter.
4. Connect the measurement equipment as shown in Figure 3-5.
 - The low pass filter is required to limit the range of frequencies passed into the R-channel input port. The filter is selected to pass the IF frequencies for the measurement but prevent the LO feedthrough and unwanted mixer products from confusing the phase lock loop operation.
 - A pad is used to isolate the filter and improve the IF port match for the mixer.
 - The attenuation of the power splitter is used to improve the RF port match for the mixer.

Caution To prevent connector damage, use an adapter (HP part number 1250-1462) as a connector saver for R CHANNEL IN.

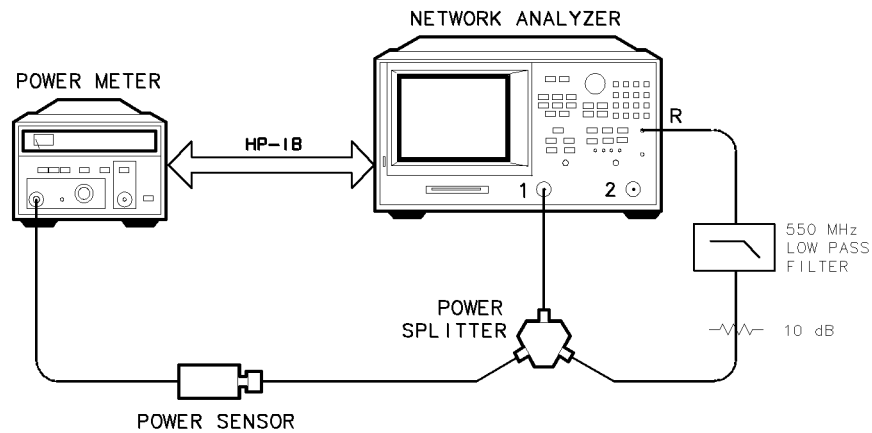

pg6245d

Figure 3-5. Connections for R Channel and Source Calibration

- From the front panel of the HP 8753D or analyzer, set the desired receiver frequency and source output power, by pressing:

```

[SYSTEM] INSTRUMENT MODE [FREQ OFFS MENU]
[START] [100] [M/μ]
[STOP] [350] [M/μ]
[FREQ OFFS ON]
[MENU] POWER [0] [x1]

```

- To view the measurement trace, press:

```
[MEAS] INPUT PORTS [R]
```

- Select the HP 8753D as the system controller:

```
[LOCAL]
[SYSTEM CONTROLLER]

```

- Set the power meter's address:

```
[SET ADDRESSES]
[ADDRESS: P MTR/HPIB] [##] [x1]

```

- Select the appropriate power meter by pressing **POWER MTR** [] until the correct model number is displayed (HP 436A or HP 438A/437).
- Press **[CAL] PWRMTR CAL LOSS/SENSR LISTS CAL FACTOR SENSOR A** and enter the correction factors as listed on the power sensor. Press **ADD FREQUENCY** [XX] [M/μ] **CAL FACTOR** [XX] [x1] **DONE** for each correction factor. When finished, press **DONE**.

11. To perform a one sweep power meter calibration over the IF frequency range at 0 dBm, press:

[CAL]
 PWRMTR CAL
 ONE SWEEP
 [0] [x1]
 TAKE CAL SWEEP

Note Because power meter calibration requires a longer sweep time, you may want to reduce the number of points before pressing TAKE CAL SWEEP. After the power meter calibration is finished, return the number of points to its original value and the analyzer will automatically interpolate this calibration.

12. To calibrate the R-channel over the IF range, press:

[CAL] RECEIVER CAL
 TAKE RCVR CAL SWEEP

Once completed, the display should read 0 dBm.

13. Make the connections as shown in Figure 3-6 for the one-sweep power meter calibration over the RF range.

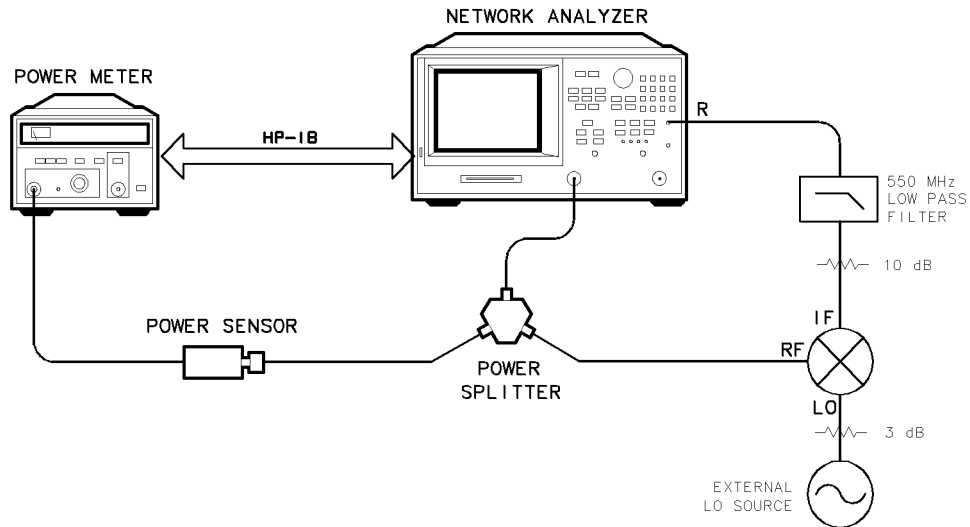

pg6246d

Figure 3-6.
Connections for a One-Sweep Power Meter Calibration for Mixer Measurements

14. To set the frequency offset mode LO frequency from the analyzer, press:

[SYSTEM]
 INSTRUMENT MODE
 FREQ OFFS MENU
 LO MENU FREQUENCY: CW [1000] [M/ μ]

15. To select the converter type and a high-side LO measurement configuration, press:

RETURN

DOWN CONVERTER

RF < LO

Notice, in this high-side LO, down conversion configuration, the analyzer's source is actually sweeping backwards, as shown in Figure 3-7. The measurements setup diagram is shown in Figure 3-8.

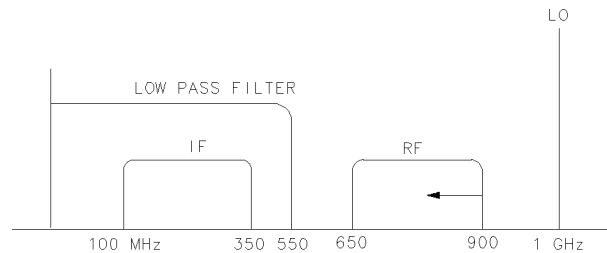

pg6155d

Figure 3-7. Diagram of Measurement Frequencies

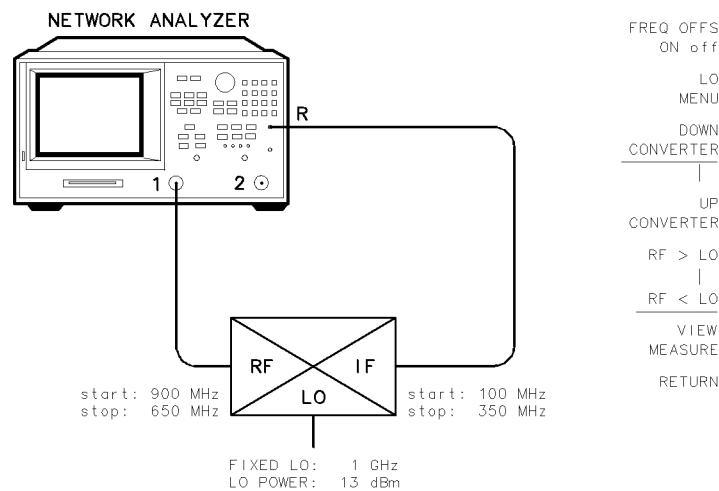

pg6247d

Figure 3-8. Measurement Setup from Display

16. To view the measurement trace, press:

VIEW MEASURE

17. To perform a one-sweep power meter calibration over the RF frequency range, press:

CAL PWRMTR CAL ONE SWEEP 0 x1 TAKE CAL SWEEP

Note *Do not* reduce the number of points to perform this power meter calibration. Reducing the number of points will turn off the receiver calibration.

The analyzer is now displaying the conversion loss of the mixer calibrated with power meter accuracy.

18. To view the conversion loss in the best vertical resolution, press:

SCALE REF **AUTOSCALE**

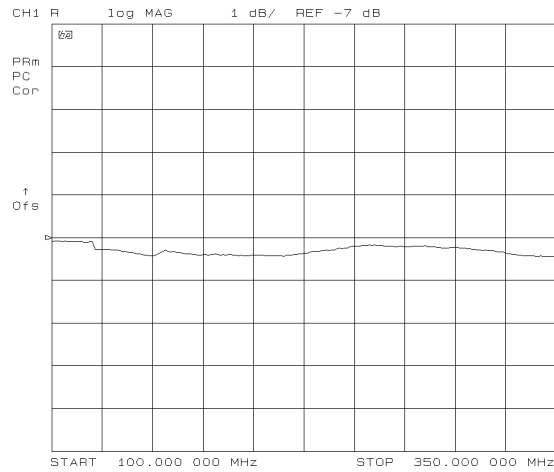

Figure 3-9. Conversion Loss Example Measurement

$$\text{Conversion loss/gain} = \text{output power} - \text{input power}$$

In this measurement, you set the input power and measured the output power. Figure 3-9 shows the absolute loss through the mixer versus mixer output frequency. If the mixer under test contained built-in amplification, then the measurement results would have shown conversion gain.

High Dynamic Range Swept RF/IF Conversion Loss

The HP 8753D's frequency offset mode enables the testing of high dynamic range frequency converters (mixers), by tuning the analyzer's high dynamic range receiver above or below its source, by a fixed offset. This capability allows the complete measurement of both pass and reject band mixer characteristics.

The analyzer has a 35 dB dynamic range limitation on measurements made directly with its R (phaselock) channel. For this reason, the measurement of high dynamic range mixing devices (such as mixers with built in amplification and filtering) with greater than 35 dB dynamic range must be made on either the analyzer's A or B channel, with a reference mixer providing input to the analyzer's R-channel for phaselock.

This example describes the swept IF conversion loss measurement of a mixer and filter. The output filtering demonstrates the analyzer's ability to make high dynamic range measurements.

To avoid the complexity of performing a separate power meter calibration over the RF frequency range while the mixer under test and reference mixer are operating, a broad band power meter calibration is used. The broad band calibration covers the entire range of IF and RF frequencies.

1. Set the following analyzer parameters:

```
PRESET
START 100 M/μ
STOP 2.5 G/n

MENU POWER PWR RANGE MAN 0 x1
```

2. Calibrate and zero the power meter.
3. Connect the measurement equipment as shown in Figure 3-10.

Caution To prevent connector damage, use an adapter (HP part number 1250-1462) as a connector saver for R CHANNEL IN.

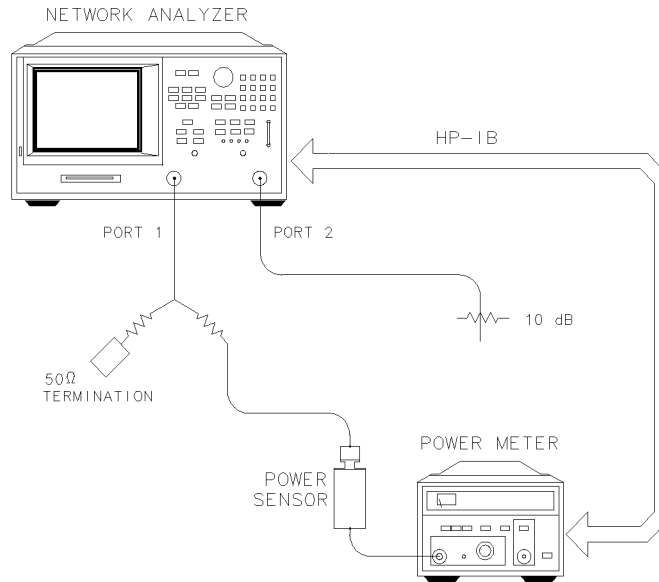

pg6248d

Figure 3-10. Connections for Broad Band Power Meter Calibration

4. Select the HP 8753D as the system controller:

LOCAL
SYSTEM CONTROLLER

5. Set the power meter's address:

SET ADDRESSES
ADDRESS: P MTR/HPIB **##** **x1**

6. Select the appropriate power meter by pressing **POWER MTR** [] until the correct model number is displayed (HP 436A or HP 438A/437).

7. Press **CAL** **PWRMTR CAL** **LOSS/SENSR LISTS** **CAL FACTOR SENSOR A** and enter the correction factors as listed on the power sensor. Press **ADD FREQUENCY** **XX** **M/μ** **CAL FACTOR** **XX** **x1** **DONE** for each correction factor. When finished, press **DONE** **RETURN**.

8. **MEAS** **INPUT PORTS** **B**

9. **CAL** **PWRMTR CAL**

10. Perform a one sweep power meter calibration over the IF frequency range at 0 dBm:

ONE SWEEP
0 **x1**
TAKE CAL SWEEP

Note Because power meter calibration requires a longer sweep time, you may want to reduce the number of points before pressing **TAKE CAL SWEEP**. After the power meter calibration is finished, return the number of points to its original value and the analyzer will automatically interpolate this calibration.

11. Connect the measurement equipment as shown in Figure 3-11.

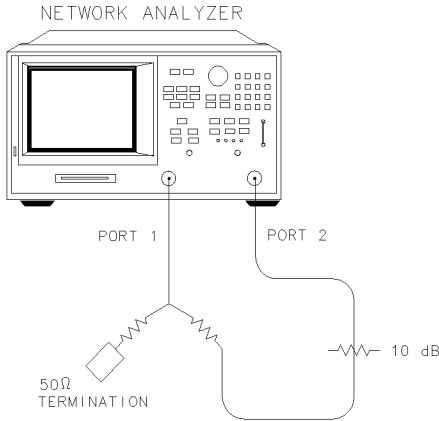

pg6249d

Figure 3-11. Connections for Receiver Calibration

12. Set the following analyzer parameters:

START **100** **(M/μ)**
STOP **1** **(G/n)**

13. To calibrate the B-channel over the IF range, press:

CAL **RECEIVER CAL** **TAKE RCVR CAL SWEEP**

Once completed, the analyzer should display 0 dBm.

14. Make the connections shown in Figure 3-12.

15. Set the LO source to the desired CW frequency and power level. For this example the values are as follows:

- CW frequency = 1500 MHz
- source power = 13 dBm

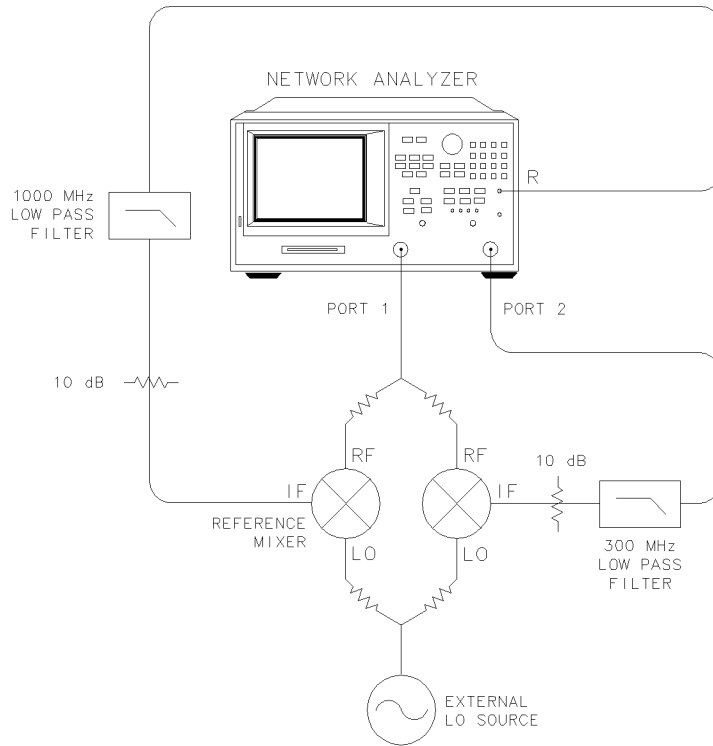

pg6250d

Figure 3-12.
Connections for a High Dynamic Range Swept IF Conversion Loss Measurement

16. To set the frequency offset mode LO frequency, press:

(SYSTEM) INSTRUMENT MODE FREQ OFFS MENU
LO MENU FREQUENCY: CW **(1500)** (M/ μ)

17. To select the converter type and low-side LO measurement configuration, press:

(RETURN)
(DOWN CONVERTER) RF>LO FREQ OFFS ON

In this low-side LO, down converter measurement, the analyzer's source frequency range will be offset higher than the receiver frequency range. The source frequency range can be determined from the following equation:

$$\text{receiver frequency range (100 - 1000 MHz) + LO frequency (1500 MHz) = 1.6-2.5 GHz}$$

18. To view the conversion loss in the best vertical resolution, press:

(VIEW MEASURE)
(SCALE REF) AUTOSCALE

Figure 3-13 shows the conversion loss of this low-side LO, mixer with output filtering. Notice that the dynamic range from the pass band to the noise floor is well above the dynamic range limit of the R Channel. If the mixer under test also contained amplification, then this dynamic range would have been even greater due to the conversion gain of the mixer.

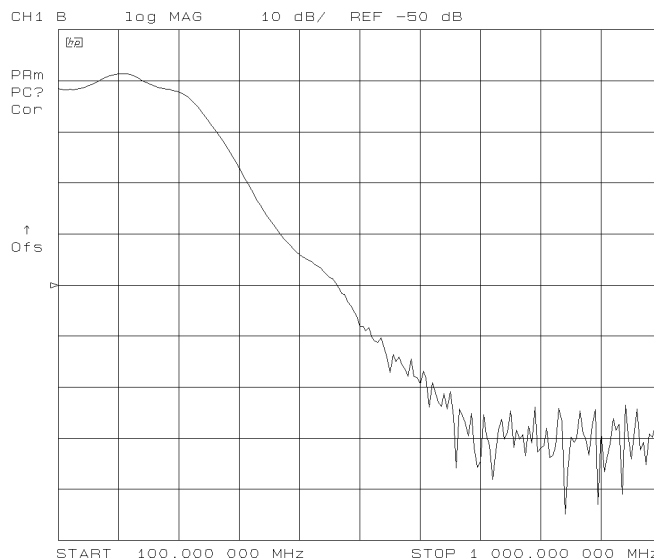

Figure 3-13. Example of Swept IF Conversion Loss Measurement

Fixed IF Mixer Measurements

A fixed IF can be produced by using both a swept RF and LO that are offset by a certain frequency. With proper filtering, only this offset frequency will be present at the IF port of the mixer.

This measurement requires two external RF sources as stimuli. Figure 3-15 shows the hardware configuration for the fixed IF conversion loss measurement. This example measurement procedure uses the analyzer's test sequence function for automatically controlling the two external synthesizers (with SCPI commands), and making a conversion loss measurement in tuned receiver mode. The test sequence function is an instrument automation feature internal to the analyzer. For more information on the test sequence function refer to "Test Sequencing" located in Chapter 2.

Tuned Receiver Mode

The analyzer's tuned receiver mode allows you to tune its receiver to an arbitrary frequency and measure signal power. This is only possible if the signal you wish to analyze is at an exact known frequency. Therefore, the RF and LO sources must be synthesized and synchronized with the analyzer's time base.

Sequence 1 Setup

The following sequence initializes and calibrates the network analyzer. It then initializes the two external sources prior to measurement. This sequence includes:

- putting the network analyzer into tuned receiver mode
 - setting up a frequency list sweep of 26 points
 - performing a response calibration
 - prompting the user to connect a mixer to the test set up
 - initializing a loop counter value to 26
 - addressing and configuring the two sources
 - calling the next measurement sequence
1. Make the following connections as shown in Figure 3-14. Set the HP-IB address of the external RF source to 19 and the external LO source to 21.
 2. Confirm that the external sources are configured to receive commands in the SCPI programming language and that their output power is switched on.

Note You may have to consult the User's Guide of the external source being used to determine how to set the source to receive SCPI commands.

3. Be sure to connect the 10 MHz reference signals of the external sources to the EXT REF connector on the rear panel of the analyzer (a BNC tee must be used).

Note If the 10 MHz reference signals of the external sources are connected together, then it will only be necessary to connect one reference signal from one of the sources to the EXT REF connector of the analyzer.

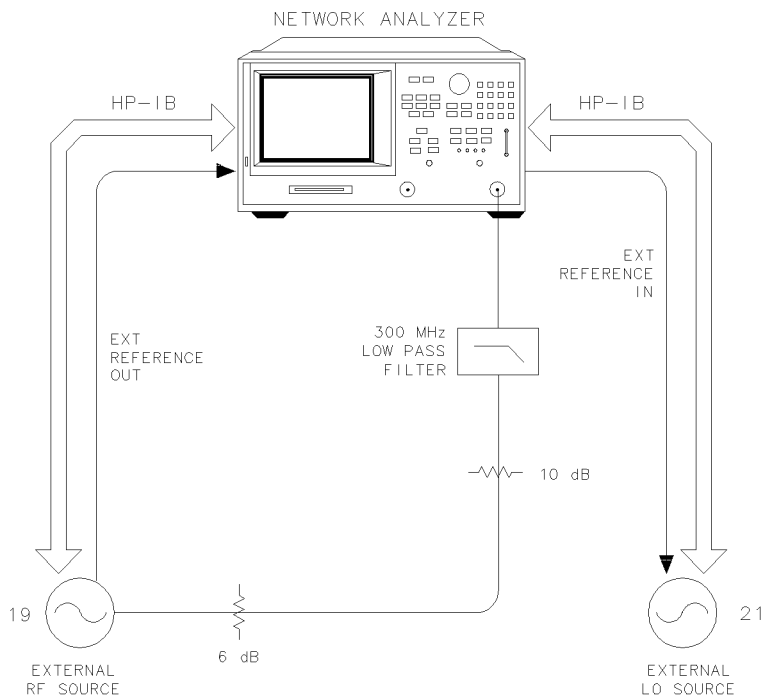

pg6251d

Figure 3-14. Connections for a Response Calibration

4. Press the following keys on the analyzer to create sequence 1:

Note To enter the following sequence commands that require titling, an external keyboard may be used for convenience.

[SEQ] NEW SEQ/MODIFY SEQ SEQUENCE 1 SEQ1

Presetting the Instrument

[SAVE/RECALL] SELECT DISK INTERNAL MEMORY
RETURN (Select the preset state.) **RECALL STATE**

Putting the Analyzer into Tuned Receiver Mode

[LOCAL] SYSTEM CONTROLLER
[SYSTEM] INSTRUMENT MODE TUNED RECEIVER

Setting Up a Frequency List Sweep of 26 Points

[MENU] SWEEP TYPE MENU EDIT LIST ADD
 CW FREQ **[100]** **[M/μ]**
 NUMBER OF POINTS **[26]** **[x1]** DONE DONE
 LIST FREQ

Performing a Response Calibration

[MEAS] INPUT PORTS B
[DISPLAY] MORE TITLE ERASE TITLE

POW:LEV 6DBM

DONE

(SEQ) SPECIAL FUNCTIONS PERIPHERAL HPIB ADDR (19) (x1)

TITLE TO PERIPHERAL

(DISPLAY) MORE TITLE ERASE TITLE

FREQ:MODE CW;CW 100MHZ

DONE

(SEQ) SPECIAL FUNCTIONS PERIPHERAL HPIB ADDR (19) (x1)

TITLE TO PERIPHERAL

(CAL) CALIBRATE MENU RESPONSE

THRU

Prompting the User to Connect a Mixer to the Test Set Up

(DISPLAY) MORE TITLE ERASE TITLE

CONNECT MIXER

DONE

(SEQ) SPECIAL FUNCTIONS

PAUSE

Initializing a Loop Counter Value to 26

(SEQ) SPECIAL FUNCTIONS DECISION MAKING

LOOP COUNTER (26) (x1)

(SCALE REF) (2) (x1)

REFERENCE POSITION (0) (x1)

REFERENCE VALUE (-20) (x1)

(MENU) TRIGGER MENU MANUAL TRG ON POINT

Addressing and Configuring the Two Sources

(DISPLAY) MORE TITLE ERASE TITLE

FREQ:MODE CW;CW 500MHZ;:FREQ:CW:STEP 100MHZ

DONE

(SEQ) SPECIAL FUNCTIONS PERIPHERAL HPIB ADDR (19) (x1)

TITLE TO PERIPHERAL

(DISPLAY) MORE TITLE ERASE TITLE

POW:LEV 13DBM

DONE

(SEQ) SPECIAL FUNCTIONS PERIPHERAL HPIB ADDR (21) (x1)

TITLE TO PERIPHERAL

(DISPLAY) MORE TITLE ERASE TITLE

FREQ:MODE CW;CW 600MHZ;:FREQ:CW:STEP 100MHZ

DONE

(SEQ) SPECIAL FUNCTIONS PERIPHERAL HPIB ADDR (21) (x1)

TITLE TO PERIPHERAL

Calling the Next Measurement Sequence

SEQ DO SEQUENCE SEQUENCE 2 SEQ2

SEQ DONE SEQ MODIFY

Press **SEQ** NEW SEQ/MODIFY SEQ SEQUENCE 1 SEQ 1 and the analyzer will display the following sequence commands:

```
SEQUENCE SEQ1
  Start of Sequence
RECALL PRST STATE
SYSTEM CONTROLLER
TUNED RECEIVER
EDIT LIST
ADD
CW FREQ
  100M/u
NUMBER OF POINTS
  26x1
DONE
DONE
LIST FREQ
  B
TITLE
  POW:LEV 6DBM
PERIPHERAL HPIB ADDR
  19x1
TITLE TO PERIPHERAL
TITLE
  FREQ:MODE CW;CW 100MHZ
TITLE TO PERIPHERAL
CALIBRATE: RESPONSE
CAL STANDARD
DONE CAL CLASS
TITLE
  CONNECT MIXER
PAUSE
LOOP COUNTER
  26x1
SCALE/DIV
  2 x1
REFERENCE POSITION
  0 x1
REFERENCE VALUE
  -20x1
MANUAL TRG ON POINT
TITLE
  FREQ:MODE CW;CW 500MHZ;:FREQ:CW:STEP 100MHZ
TITLE TO PERIPHERAL
TITLE
  POW:LEV 13DBM
PERIPHERAL HPIB ADDR
  21x1
TITLE TO PERIPHERAL
TITLE
```

```
FREQ:MODE CW;CW 600MHZ;:FREQ:CW:STEP 100MHZ
TITLE TO PERIPHERAL
DO SEQUENCE
SEQUENCE 2
```

Sequence 2 Setup

The following sequence makes a series of measurements until all 26 CW measurements are made and the loop counter value is equal to zero. This sequence includes:

- taking data
- incrementing the source frequencies
- decrementing the loop counter
- labeling the screen

1. Press the following keys on the analyzer to create sequence 2:

Note To enter the following sequence commands that require titling, an external keyboard may be used for convenience.

```
(SEQ) DONE SEQ MODIFY
(SEQ) NEW SEQ/MODIFY SEQ SEQUENCE 2 SEQ2
```

Taking Data

```
(SEQ) SPECIAL FUNCTIONS WAIT x (1) (x1)
(MENU) TRIGGER MENU MANUAL TRG ON POINT
```

Incrementing the Source Frequencies

```
(DISPLAY) MORE TITLE ERASE TITLE
FREQ:CW UP
DONE
(SEQ) SPECIAL FUNCTIONS PERIPHERAL HP IB ADDR (19) (x1)
TITLE TO PERIPHERAL
PERIPHERAL HP IB ADDR (21) (x1) TITLE TO PERIPHERAL
```

Decrementing the Loop Counter

```
DECISION MAKING DECR LOOP COUNTER IF LOOP COUNTER<>0 SEQUENCE 2 SEQ2
```

Labeling the Screen

```
(DISPLAY) MORE TITLE ERASE TITLE
MEASUREMENT COMPLETED
DONE
(SEQ) DONE SEQ MODIFY
```

Press (SEQ) NEW SEQ/MODIFY SEQ SEQUENCE 2 SEQ 2 and the analyzer will display the following sequence commands:

```
SEQUENCE SEQ2
Start of Sequence
WAIT x
.1 x1
```

```

MANUAL TRG ON POINT
TITLE
FREQ: CW UP
PERIPHERAL HPIB ADDR
19x1
TITLE TO PERIPHERAL
PERIPHERAL HPIB ADDR
21x1
TITLE TO PERIPHERAL
DECR LOOP COUNTER
IF LOOP COUNTER <>0 THEN DO
SEQUENCE 2
TITLE
MEASUREMENT COMPLETED

```

2. Press the following keys to run the sequences:

SEQ **DONE** **SEQ** **MODIFY** **DO** **SEQUENCE** **SEQUENCE2** **SEQ2**

When the prompt CONNECT MIXER appears, connect the equipment as shown in Figure 3-15.

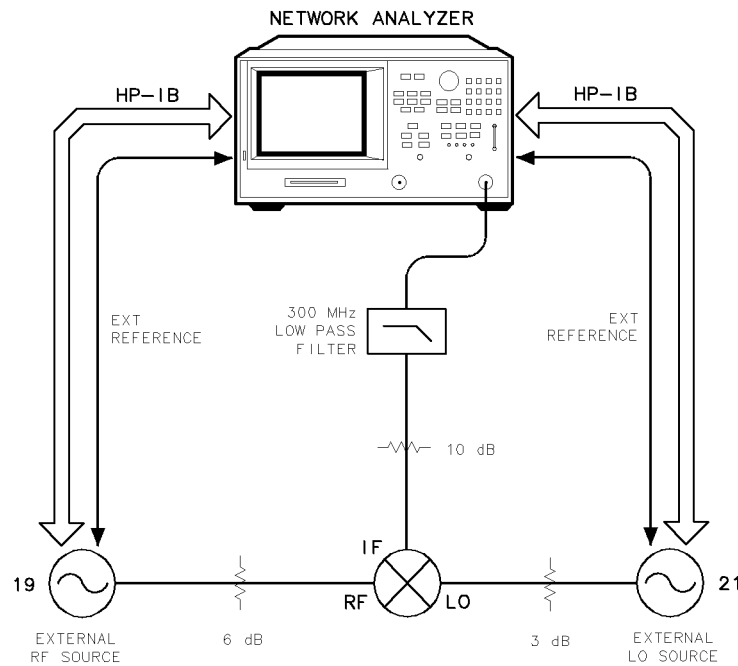

pg6252d

Figure 3-15. Connections for a Conversion Loss Using the Tuned Receiver Mode

When the sequences are finished you should have a result as shown in Figure 3-16.

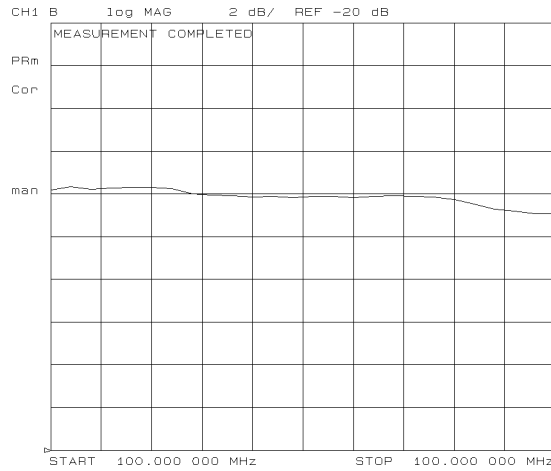

Figure 3-16. Example Fixed IF Mixer Measurement

The displayed trace represents the conversion loss of the mixer at 26 points. Each point corresponds to one of the 26 different sets of RF and LO frequencies that were used to create the same fixed IF frequency.

Phase or Group Delay Measurements

For information on group delay principles, refer to “Group Delay Principles” in Chapter 6. The accuracy of this measurement depends on the quality of the mixer that is being used for calibration and how well this mixer has been characterized. The following measurement must be performed with a broadband calibration mixer that has a known group delay. The following table lists the specifications of two mixers that may be used for calibration:

Model Number	Useful Frequency Range	Group Delay
ANZAC MCD-123	.03 to 3 GHz	.5 ns
Mini-Circuits ZFM-4	dc to 1250 MHz	.6 ns

1. Set the LO source to the desired CW frequency and power level. For this example the LO source is set to the following values:

CW frequency = 1000 MHz

power = 13 dBm

2. Initialize the analyzer by pressing **PRESET**.
3. From the front panel of the HP 8753D, set the desired receiver frequency and source output power by pressing:

CENTER **300** **(M/μ)**

SPAN **100** **(M/μ)**

MENU **POWER** **PWR RANGE MAN** **0** **(x1)**

4. Connect the instruments as shown in Figure 3-17, placing a broadband “calibration” mixer (ZFM-4) between PORT 1 and PORT 2.

Caution To prevent connector damage, use an adapter (HP part number 1250-1462) as a connector saver for R CHANNEL IN.

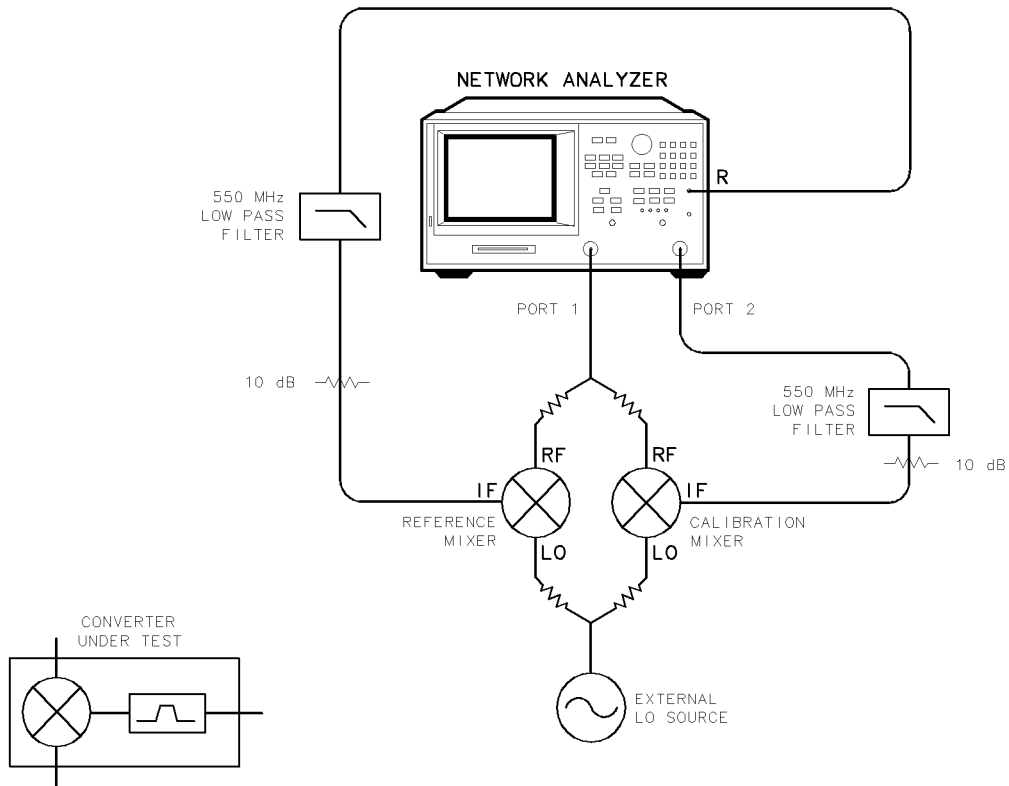

pg6253d

Figure 3-17. Connections for a Group Delay Measurement

- To set the frequency offset mode LO frequency from the analyzer, press:

SYSTEM
 INSTRUMENT MODE
 FREQ OFFS MENU
 VIEW MEASURE
 LO MENU FREQUENCY: CW 1000 M/μ

- To select the converter type and a high-side LO measurement configuration, press:

RETURN
 DOWN CONVERTER
 RF < LO
 FREQ OFFS ON

- To select the format type, press:

FORMAT DELAY

8. To make a response error-correction, press:

MEAS INPUT PORTS B/R

CAL CALIBRATE MENU RESPONSE THRU

9. Replace the “calibration” mixer with the device under test. If measuring group delay, set the delay equal to the “calibration” mixer delay (for example -0.6 ns) by pressing:

SCALE REF

ELECTRICAL DELAY

-0.6 **G/n**

10. Scale the data for best vertical resolution.

SCALE REF

AUTOSCALE

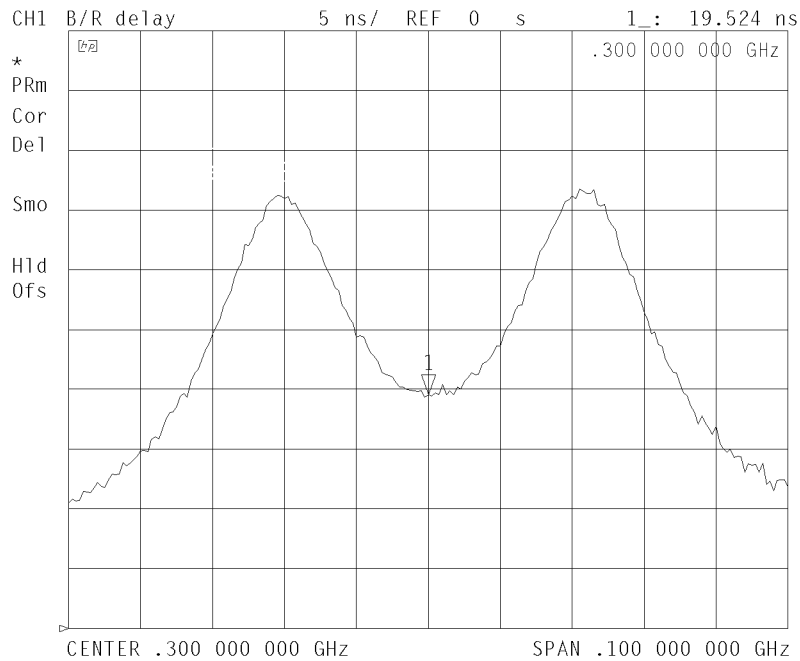

pb6102d

Figure 3-18. Group Delay Measurement Example

The displayed measurement trace shows the device under test delay, relative to the “calibration” mixer. This measurement is also useful when the device under test has built-in filtering, which requires >30 dB range (the maximum of R input). PORT 1 to PORT 2 range is >100 dB.

Amplitude and Phase Tracking

Using the same measurement set-up as in “Phase or Group Delay Measurements,” you can determine how well two mixers track each other in terms of amplitude and phase.

1. Repeat steps 1 through 8 of the previous “Group Delay Measurements” section with the following exception:

In step 7, select **FORMAT** **PHASE**.

2. Once the analyzer has displayed the measurement results, press **DISPLAY** **DATA—MEM**.
3. Replace the calibration mixer with the mixer under test.
4. Press **DATA/MEM**.

The resulting trace should represent the amplitude and phase tracking of the two mixers.

Conversion Compression Using the Frequency Offset Mode

Conversion compression is a measure of the maximum RF input signal level, where the mixer provides linear operation. The conversion loss is the ratio of the IF output level to the RF input level. This value remains constant over a specified input power range. When the input power level exceeds a certain maximum, the constant ratio between IF and RF power levels will begin to change. The point at which the ratio has decreased 1 dB is called the 1 dB compression point. See Figure 3-19.

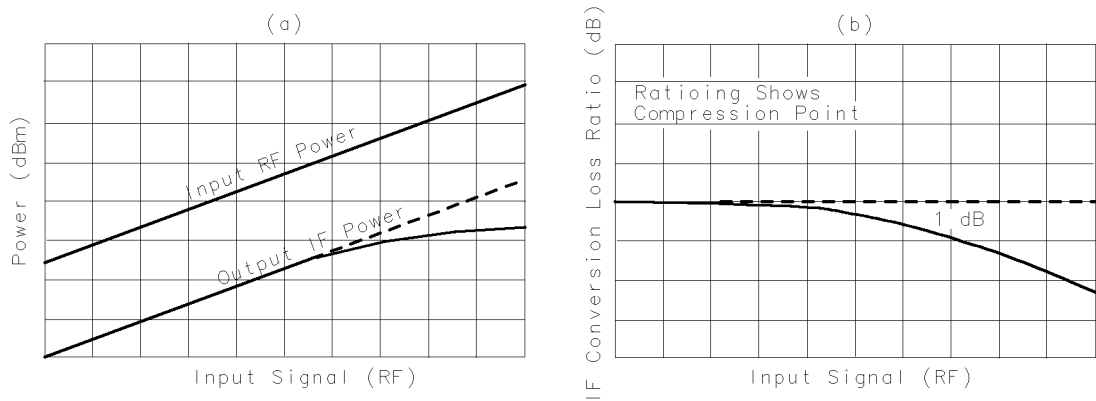

pb6100d

Figure 3-19.
Conversion Loss and Output Power as a Function of Input Power Level Example

Notice that the IF output power increases linearly with the increasing RF signal, until mixer compression begins and the mixer saturates.

The following example uses a ratio of mixer output to input power and a marker search function to locate a mixer's 1 dB compression point.

1. Set the LO source to the desired CW frequency and power level.

CW frequency = 600 MHz
Power = 13 dBm

2. Initialize the analyzer by pressing **(PRESET)**.
3. To set the desired CW frequency and power sweep range, press:

```

(MENU)
SWEEP TYPE MENU POWER SWEEP RETURN
CW FREQ
(800) (M/μ)
POWER PWR RANGE MAN
POWER RANGES RANGE 0
(START) (-10) (x1)
(STOP) (10) (x1)
    
```

4. Make the connections, as shown in Figure 3-20.

Caution To prevent connector damage, use an adapter (HP part number 1250-1462) as a connector saver for R CHANNEL IN.

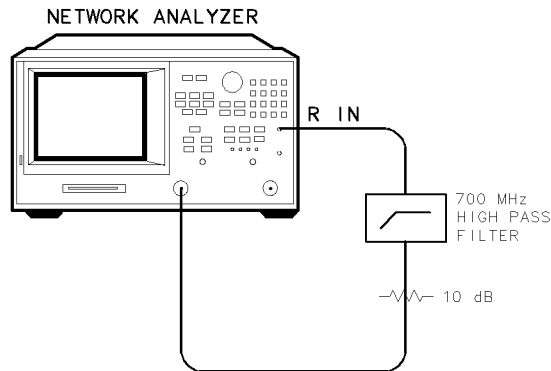

pg6254d

Figure 3-20. Connections for the First Portion of Conversion Compression Measurement

5. To view the absolute input power to the analyzer's R-channel, press:

MEAS **INPUT PORTS** **R**

6. To store a trace of the receiver power versus the source power into memory and view data/memory, press:

DISPLAY
DATA → **MEMORY**
DATA/MEM

This removes the loss between the output of the mixer and the input to the receiver, and provides a linear power sweep for use in subsequent measurements.

7. Make the connections as shown in Figure 3-21.

Caution To prevent connector damage, use an adapter (HP part number 1250-1462) as a connector saver for R CHANNEL IN.

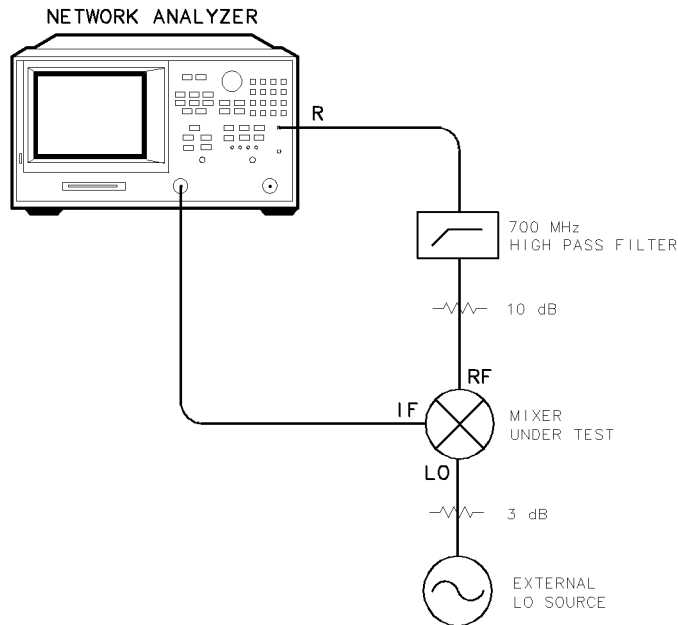

pg6255d

Figure 3-21.
Connections for the Second Portion of Conversion Compression Measurement

8. To set the frequency offset mode LO frequency, press:

```
SYSTEM  
INSTRUMENT MODE FREQ OFFS MENU  
LO MENU FREQUENCY: CW 600 (M/μ)
```

9. To select the converter type, press:

```
RETURN  
UP CONVERTER
```

10. To select a low-side LO measurement configuration, press:

```
RF>LO  
FREQ OFFS ON
```

In this low-side LO, up converter measurement, the analyzer source frequency is offset lower than the receiver frequency. The analyzer source frequency can be determined from the following equation:

$$\text{receiver frequency (800 MHz)} - \text{LO frequency (600 MHz)} = 200 \text{ MHz}$$

The measurements setup diagram is shown in Figure 3-22.

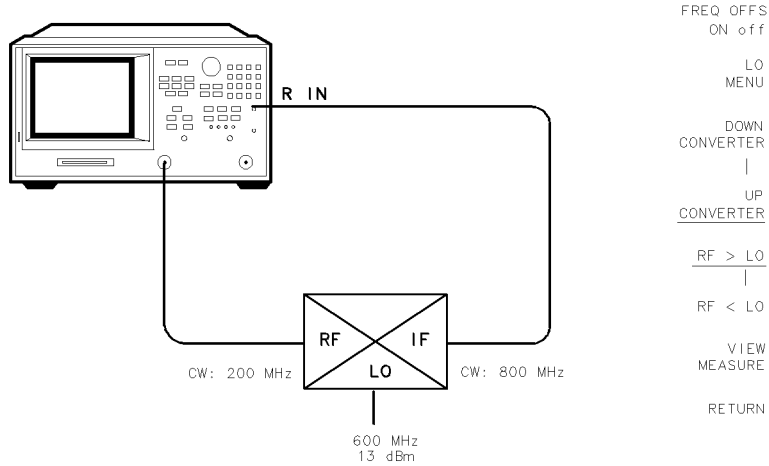

Figure 3-22. Measurement Setup Diagram Shown on Analyzer Display

11. To view the mixer's output power as a function of its input power, press:

VIEW MEASURE

12. To set up an active marker to search for the 1 dB compression point of the mixer, press:

SCALE REF

AUTO SCALE

MARKER FCTN MKR SEARCH ON SEARCH:MAX

13. Press:

MARKER MKR ZERO

MARKER FCTN

MKR SEARCH ON TARGET (-1) (x1)

The measurement results show the mixer's 1 dB compression point. By changing the target value, you can easily locate other compression points (for example, 0.5 dB, 3 dB). See Figure 3-22.

14. Read the compressed power on by turning marker Δ off.

MARKER Δ MODE Δ MODE OFF .

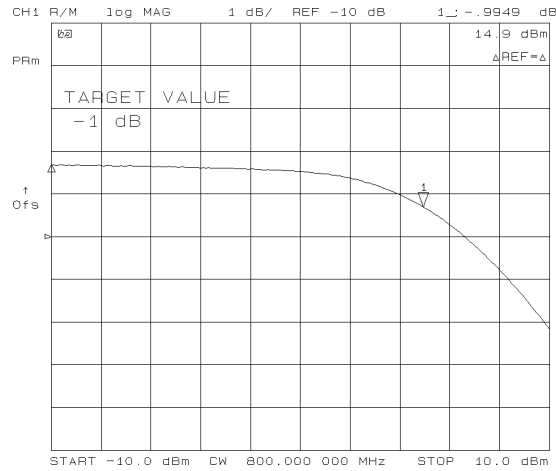
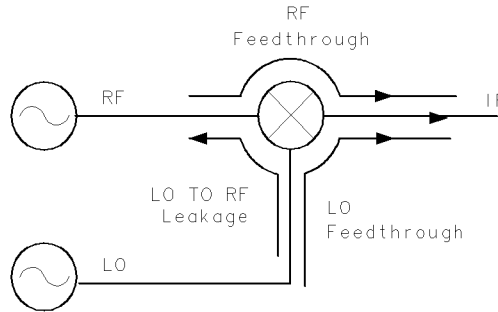

Figure 3-23.
Example Swept Power Conversion Compression Measurement

Isolation Example Measurements

Isolation is the measure of signal leakage in a mixer. Feedthrough is specifically the forward signal leakage to the IF port. High isolation means that the amount of leakage or feedthrough between the mixer's ports is very small. Isolation measurements do not use the frequency offset mode. Figure 3-24 illustrates the signal flow in a mixer.



pg6105d

Figure 3-24. Signal Flow in a Mixer Example

The RF and LO feedthrough signals may appear at the mixer IF output, together with the desired IF signal.

The LO to RF isolation and the LO feedthrough are typically measured with the third port terminated in 50 ohms. Measurement of the RF feedthrough is made as the LO signal is being applied to the mixer.

LO to RF Isolation

1. Initialize the analyzer by pressing **PRESET**.
2. To select the analyzer frequency range and source power, press:

START **10** **(M/μ)**
STOP **3000** **(M/μ)**
MENU **POWER** **PWR RANGE** **MAN** **0** **(x1)**

This source stimulates the mixer's LO port.

3. To select a ratio B/R measurement, press:

MEAS **INPUT PORTS** **B/R**

4. Make the connections as shown in Figure 3-25.

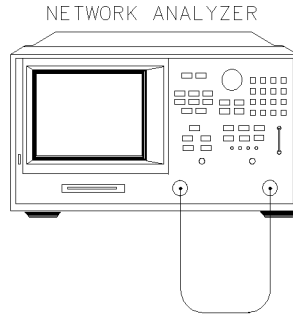

pg6256d

Figure 3-25. Connections for a Response Calibration

5. Perform a response calibration by pressing **[CAL]** **CALIBRATE MENU** **RESPONSE THRU**.

Note A full 2 port calibration will increase the accuracy of isolation measurements. Refer to Chapter 5, “Optimizing Measurement Results.”

6. Make the connections as shown in Figure 3-26.

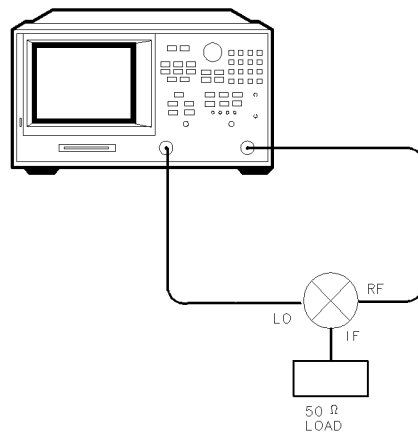

pg6102d

Figure 3-26. Connections for a Mixer Isolation Measurement

7. To adjust the display scale, press:

[SCALE REF]
AUTO SCALE

The measurement results show the mixer’s LO to RF isolation.

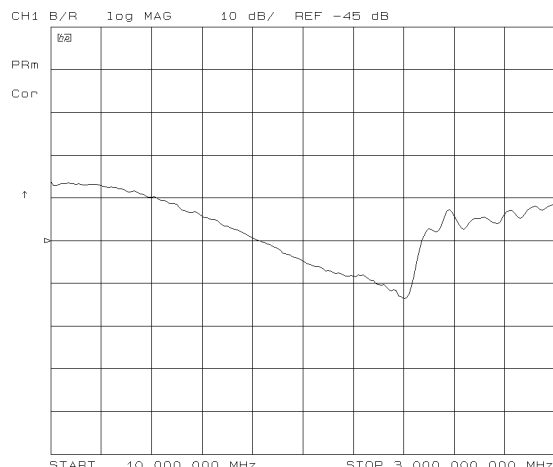

Figure 3-27. Example Mixer LO to RF Isolation Measurement

RF Feedthrough

The procedure and equipment configuration necessary for this measurement are very similar to those above, with the addition of an external source to drive the mixer's LO port as we measure the mixer's RF feedthrough. RF feedthrough measurements do not use the frequency offset mode.

1. Select the CW LO frequency and source power from the front panel of the external source.

CW frequency = 300 MHz

Power = 10 dBm

2. Initialize the analyzer by pressing **[PRESET]**.
3. To select the analyzer's frequency range and source power, press:

[START] **[10]** **[M/μ]**

[STOP] **[3000]** **[M/μ]**

[MENU] **POWER PWR RANGE MAN** **[0]** **[x1]**

This signal stimulates the mixer's RF port.

4. To select a ratio measurement, press:

[MEAS] **INPUT PORTS** **B/R**

Note Isolation is dependent on LO power level and frequency. To ensure good test results, you should choose these parameters as close to actual operating conditions as possible.

5. Make the connections as shown in Figure 3-28.

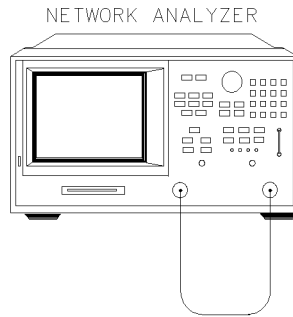

pg6256d

Figure 3-28. Connections for a Response Calibration

6. Perform a response calibration by pressing (CAL) CALIBRATE MENU RESPONSE THRU
7. Make the connections as shown in Figure 3-29.

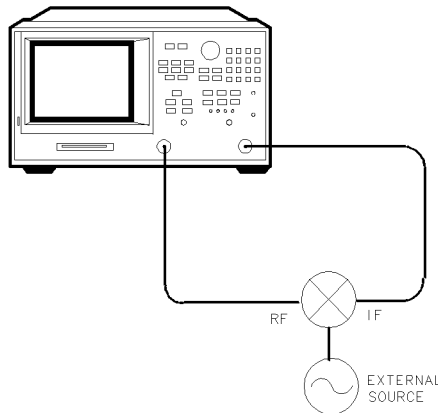

pg6114d

Figure 3-29. Connections for a Mixer RF Feedthrough Measurement

8. Connect the external LO source to the mixer's LO port.
9. The measurement results show the mixer's RF feedthrough.

Note You may see spurious responses on the analyzer trace due to interference caused by LO to IF leakage in the mixer. This can be reduced with averaging or by reducing the IF bandwidth.

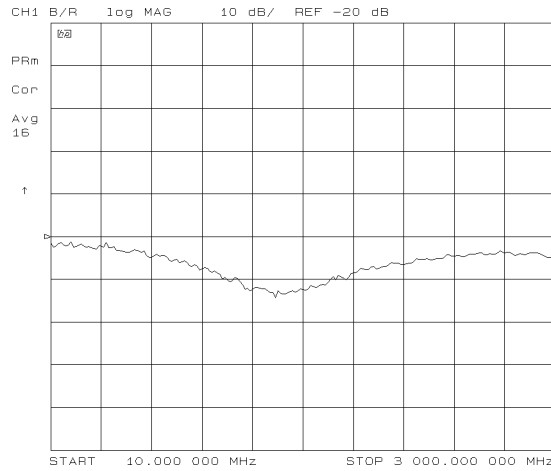

Figure 3-30. Example Mixer RF Feedthrough Measurement

You can measure the IF to RF isolation in a similar manner, but with the following modifications:

- use the analyzer source as the IF signal drive
- view the leakage signal at the RF port

Printing, Plotting, and Saving Measurement Results

This chapter contains instructions for the following tasks:

- Printing or plotting your measurement results
 - Configuring a print function
 - Defining a print function
 - Printing one measurement per page
 - Printing multiple measurements per page
 - Printing time
 - Configuring a plot function
 - Defining a plot function
 - Plotting one measurement per page using a pen plotter
 - Plotting multiple measurements per page using a pen plotter
 - Plotting time
 - Plotting a measurement to disk
 - Outputting plot files from a PC to a plotter
 - Outputting plot files from a PC to an HPGL compatible printer
 - Outputting single page plots using a printer
 - Outputting multiple plots to a single page using a printer
 - Plotting Multiple Measurements per page from disk
 - Titling the displayed measurement
 - Configuring the analyzer to produce a time stamp
 - Aborting a print or plot process
 - Printing or plotting the list values or operating parameters
 - Solving problems with printing or plotting
- Saving and recalling instrument states
 - Saving an instrument state
 - Saving measurement results
 - Re-saving an instrument state
 - Deleting a file
 - Renaming a file
 - Recalling a file
 - Formatting a disk
 - Solving problems with saving or recalling files

Where to Look for More Information

Additional information about many of the topics discussed in this chapter is located in the following areas:

- Chapter 2, “Making Measurements,” contains step-by-step procedures for making measurements or using particular functions.
- Chapter 8, “Menu Maps,” shows softkey menu relationships.
- Chapter 9, “Key Definitions,” describes all the front panel keys, softkeys, and their corresponding HP-IB commands.
- Chapter 11, “Compatible Peripherals,” lists measurement and system accessories, and other applicable equipment compatible with the analyzers. An HP-IB programming overview is also included.

Printing or Plotting Your Measurement Results

You can print your measurement results to the following peripherals:

- printers with HP-IB interfaces
- printers with parallel interfaces
- printers with serial interfaces

You can plot your measurement results to the following peripherals:

- HPGL compatible printers with HP-IB interfaces
- HPGL compatible printers with parallel interfaces
- plotters with HP-IB interfaces
- plotters with parallel interfaces
- plotters with serial interfaces

Refer to the “Compatible Peripherals” chapter for a list of recommended peripherals.

Configuring a Print Function

All copy configuration settings are stored in non-volatile memory. Therefore, they are not affected if you press **PRESET** or switch off the analyzer power.

1. Connect the printer to the interface port.

Printer Interface	Recommended Cables
Parallel	HP 92284A
HP-IB	HP 10833A/B/D
Serial	HP 24542G

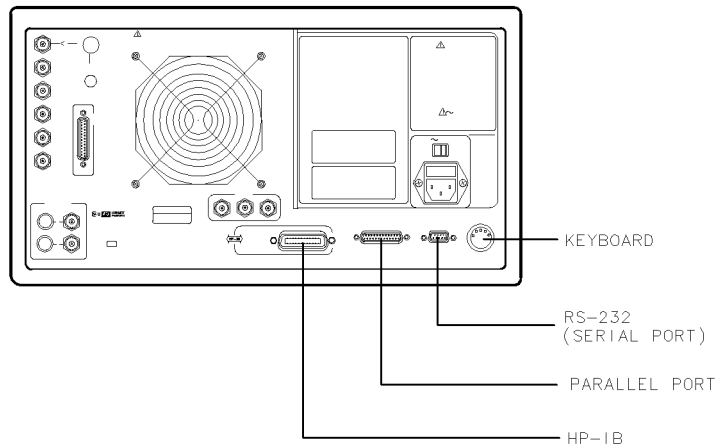

qq612d

Figure 4-1. Printer Connections to the Analyzer

2. Press **LOCAL** **SET ADDRESSES** **PRINTER PORT** **PRNTR TYPE** until the correct printer choice appears:
 - ThinkJet** (QuietJet)
 - DeskJet** (except for HP DeskJet 540 and DeskJet 850C)
 - LaserJet**
 - PaintJet**
 - Epson-P2** (printers that conform to the ESC/P2 printer control language)
 - DJ 540** (for use with the HP DeskJet 540 and DeskJet 850C)

Note Selecting **DJ 540** converts 100 dpi raster information to 300 dpi raster format. If your DeskJet printer does not support the 100 dpi raster format and your printing results seem to be less than normal size, select **DJ 540**.

3. Select one of the following printer interfaces:
 - Choose **PRNTR PORT HPIB** if your printer has an HP-IB interface, and then configure the print function as follows:
 - a. Enter the HP-IB address of the printer, followed by **[x1]**.
 - b. Press **LOCAL** and **SYSTEM CONTROLLER** if there is no external controller connected to the HP-IB bus.
 - c. Press **LOCAL** and **USE PASS CONTROL** if there is an external controller connected to the HP-IB bus.
 - Choose **PARALLEL** if your printer has a parallel (centronics) interface, and then configure the print function as follows:
 - Press **LOCAL** and then select the parallel port interface function by pressing **PARALLEL** until the correct function appears.
 - If you choose **PARALLEL [COPY]**, the parallel port is dedicated for normal copy device use (printers or plotters).
 - If you choose **PARALLEL [GPIO]**, the parallel port is dedicated for general purpose I/O, and cannot be used for printing or plotting.

- Choose **SERIAL** if your printer has a serial (RS-232) interface, and then configure the print function as follows:
 - a. Press **PRINTER BAUD RATE** and enter the printer's baud rate, followed by **(x1)**.
 - b. To select the transmission control method that is compatible with your printer, press **XMIT CNTRL** (transmit control - handshaking protocol) until the correct method appears.
 - If you choose **Xon-Xoff**, the handshake method allows the printer to control the data exchange by transmitting control characters to the network analyzer.
 - If you choose **DTR-DSR**, the handshake method allows the printer to control the data exchange by setting the electrical voltage on one line of the RS-232 serial cable.

Note Because the **DTR-DSR** handshake takes place in the hardware rather than the firmware or software, it is the fastest transmission control method.

Defining a Print Function

Note The print definition is set to default values whenever the power is cycled. However, you can save the print definition by saving the instrument state.

1. Press **(COPY) DEFINE PRINT**.
2. Press **PRINT: MONOCHROME** or **PRINT: COLOR**.
 - Choose **PRINT: MONOCHROME** if you are using a black and white printer, or you want just black and white from a color printer.
 - Choose **PRINT: COLOR** if you are using a color printer.
3. Press **AUTO-FEED** until the correct choice (ON or OFF) is high-lighted.
 - Choose **AUTO-FEED ON** if you want to print one measurement per page.
 - Choose **AUTO-FEED OFF** if you want to print multiple measurements per page.

Note Laser printers and some DeskJet printers do not begin to print until a full page, or a partial page and a form feed, have been received.

If You are Using a Color Printer

1. Press **PRINT COLORS**.
2. If you want to modify the print colors, select the print element and then choose an available color.

Note You can set all the print elements to black to create a hardcopy in black and white.

Since the media color is white or clear, you could set a print element to white if you do not want that element to appear on your hardcopy.

To Reset the Printing Parameters to Default Values

1. Press **COPY DEFINE PRINT DEFAULT PRNT SETUP**.

Table 4-1. Default Values for Printing Parameters

Printing Parameter	Default
Printer Mode	Monochrome
Auto Feed	ON
Printer Colors	
Channel 1 Data	Magenta
Channel 1 Memory	Green
Channel 2 Data	Blue
Channel 2 Memory	Red
Graticule	Cyan
Warning	Black
Text	Black

Printing One Measurement Per Page

1. Configure and define the print function, as explained in “Configuring a Print Function” and “Defining a Print Function” located earlier in this chapter.
2. Press **COPY PRINT MONOCHROME**.
 - If you defined the **AUTO-FEED OFF**, press **PRINTER FORM FEED** after the message **COPY OUTPUT COMPLETED** appears.

Printing Multiple Measurements Per Page

1. Configure and define the print function, as explained in “Configuring a Print Function” and “Defining a Print Function” located earlier in this chapter.
2. Press **(COPY) DEFINE PRINT** and then press **AUTO-FEED** until the softkey label appears as **AUTO-FEED OFF**.
3. Press **(RETURN) PRINT MONOCHROME** to print a measurement on the first half page.
4. Make the next measurement that you want to see on your hardcopy. Figure 4-2 shows an example of a hardcopy where two measurements appear.
5. Press **(COPY) PRINT MONOCHROME** to print a measurement on the second half page.

Note This feature will not work for all printers due to differences in printer resolution.

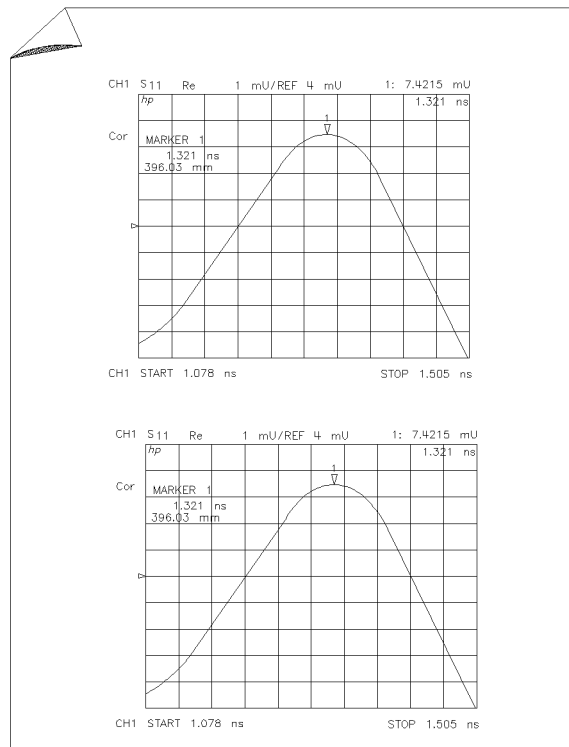

pg6148d

Figure 4-2. Printing Two Measurements

Configuring a Plot Function

All copy configuration settings are stored in non-volatile memory. Therefore, they are not affected if you press **PRESET** or switch off the analyzer power.

1. Connect the peripheral to the interface port.

Peripheral Interface	Recommended Cables
Parallel	HP 92284A
HP-IB	HP 10833A/33B/33D
Serial	HP 24542G

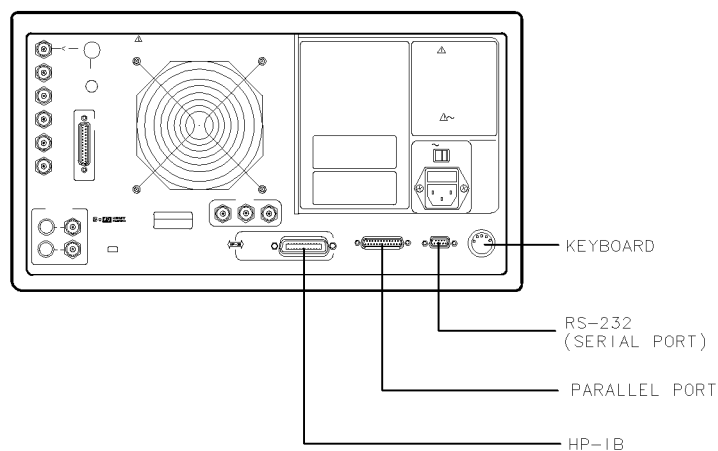

gg612d

Figure 4-3. Peripheral Connections to the Analyzer

If You are Plotting to an HPGL/2 Compatible Printer

2. Press **LOCAL** **SET ADDRESSES** **PRINTER PORT** and then press **PRNTR TYPE** until the correct printer choice appears:
 - ThinkJet** (QuietJet)
 - DeskJet** (only DeskJet 1200C and DeskJet 1600C)
 - LaserJet** (only LaserJet III and IV)
 - PaintJet**
 - Epson-P2** (printers that conform to the ESC/P2 printer control language)

3. Configure the analyzer for one of the following printer interfaces:

- Choose **PRNTR PORT HPIB** if your printer has an HP-IB interface, and then configure the print function as follows:
 - a. Enter the HP-IB address of the printer (default is 01), followed by **(x1)**.
 - b. Press **(LOCAL)** and **SYSTEM CONTROLLER** if there is no external controller connected to the HP-IB bus.
 - c. Press **(LOCAL)** and **USE PASS CONTROL** if there is an external controller connected to the HP-IB bus.
- Choose **PARALLEL** if your printer has a parallel (centronics) interface, and then configure the print function as follows:
 - Press **(LOCAL)** and then select the parallel port interface function by pressing **PARALLEL** until the correct function appears.
 - If you choose **PARALLEL [COPY]**, the parallel port is dedicated for normal copy device use (printers or plotters).
 - If you choose **PARALLEL [GPIO]**, the parallel port is dedicated for general purpose I/O, and cannot be used for printing or plotting.
- Choose **SERIAL** if your printer has a serial (RS-232) interface, and then configure the print function as follows:
 - a. Press **PRINTER BAUD RATE** and enter the printer's baud rate, followed by **(x1)**.
 - b. To select the transmission control method that is compatible with your printer, press **XMIT CNTRL** (transmit control - handshaking protocol) until the correct method appears.
 - If you choose **Xon-Xoff**, the handshake method allows the printer to control the data exchange by transmitting control characters to the network analyzer.
 - If you choose **DTR-DSR**, the handshake method allows the printer to control the data exchange by setting the electrical voltage on one line of the RS-232 serial cable.

Note Because the **DTR-DSR** handshake takes place in the hardware rather than the firmware or software, it is the fastest transmission control method.

4. Press **(LOCAL)** **SET ADDRESSES PLOTTER PORT** and then **PLTR TYPE** until **PLTR TYPE [HPGL PRT]** appears.

If You are Plotting to a Pen Plotter

1. Press **LOCAL** **SET ADDRESSES** **PLOTTER PORT** and then **PLTR TYPE** until **PLTR TYPE [PLOTTER]** appears.
2. Configure the analyzer for one of the following plotter interfaces:
 - Choose **PLTR PORT HP-IB** if your plotter has an HP-IB interface, and then configure the plot function as follows:
 - a. Enter the HP-IB address of the printer (default is 05), followed by **x1**.
 - b. Press **LOCAL** and **SYSTEM CONTROLLER** if there is no external controller connected to the HP-IB bus.
 - c. Press **LOCAL** and **USE PASS CONTROL** if there is an external controller connected to the HP-IB bus.
 - Choose **PARALLEL** if your printer has a parallel (centronics) interface, and then configure the print function as follows:
 - Press **LOCAL** and then select the parallel port interface function by pressing **PARALLEL** until the correct function appears.
 - If you choose **PARALLEL [COPY]**, the parallel port is dedicated for normal copy device use (printers or plotters).
 - If you choose **PARALLEL [GPIO]**, the parallel port is dedicated for general purpose I/O, and cannot be used for printing or plotting.
 - Choose **SERIAL** if your printer has a serial (RS-232) interface, and then configure the print function as follows:
 - a. Press **PRINTER BAUD RATE** and enter the printer's baud rate, followed by **x1**.
 - b. To select the transmission control method that is compatible with your printer, press **XMIT CNTRL** (transmit control - handshaking protocol) until the correct method appears.
 - If you choose **Xon-Xoff**, the handshake method allows the printer to control the data exchange by transmitting control characters to the network analyzer.
 - If you choose **DTR-DSR**, the handshake method allows the printer to control the data exchange by setting the electrical voltage on one line of the RS-232 serial cable.

Note Because the **DTR-DSR** handshake takes place in the hardware rather than the firmware or software, it is the fastest transmission control method.

If You are Plotting to a Disk Drive

1. Press **(LOCAL)** **SET ADDRESSES** **PLOTTER PORT** **DISK**.
2. Press **(SAVE/RECALL)** **SELECT DISK** and select the disk drive that you will plot to.
 - Choose **INTERNAL DISK** if you will plot to the analyzer internal disk drive.
 - Choose **EXTERNAL DISK** if you will plot to a disk drive that is external to the analyzer. Then configure the disk drive as follows:
 - a. Press **CONFIGURE EXT DISK** **ADDRESS: DISK** and enter the HP-IB address to the disk drive (default is 00) followed by **(x1)**.
 - b. Press **(LOCAL)** **DISK UNIT NUMBER** and enter the drive where your disk is located, followed by **(x1)**.
 - c. If your storage disk is partitioned, press **VOLUME NUMBER** and enter the volume number where you want to store the instrument state file.

Defining a Plot Function

Note The plot definition is set to default values whenever the power is cycled. However, you can save the plot definition by saving the instrument state.

1. Press **COPY** **DEFINE PLOT**.

Choosing Display Elements

2. Choose which of the following measurement display elements that you want to appear on your plot:
 - Choose **PLOT DATA ON** if you want the measurement data trace to appear on your plot.
 - Choose **PLOT MEM ON** if you want the displayed memory trace to appear on your plot.
 - Choose **PLOT GRAT ON** if you want the graticule and the reference line to appear on your plot.
 - Choose **PLOT TEXT ON** if you want all of the displayed text to appear on your plot. (This does not include the marker values or softkey labels.)
 - Choose **PLOT MKR ON** if you want the displayed markers, and marker values, to appear on your plot.

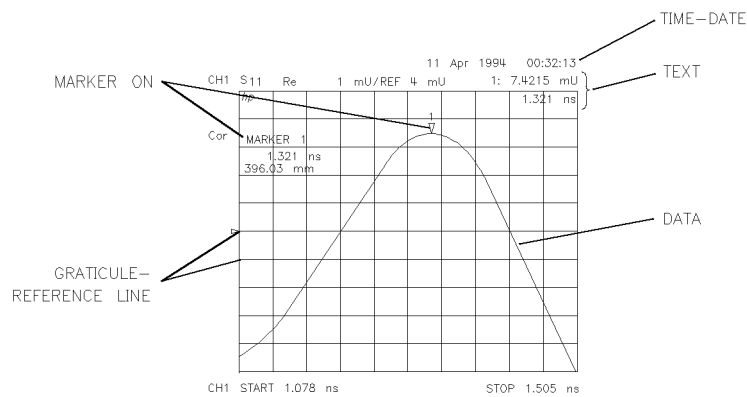

pg6150d

Figure 4-4. Plot Components Available through Definition

Selecting Auto-Feed

3. Press **AUTO-FEED** until the correct choice is high-lighted.
 - Choose **AUTO-FEED ON** if you want a “page eject” sent to the plotter or HPGL compatible printer after each time you press **PLOT**.
 - Choose **AUTO-FEED OFF** if you want multiple plots on the same sheet of paper.

Note The peripheral ignores **AUTO-FEED ON** when you are plotting to a quadrant.

Selecting Pen Numbers and Colors

4. Press **MORE** and select the plot element where you want to change the pen number. For example, press **PEN NUM DATA** and then modify the pen number. The pen number selects the color if you are plotting to an HPGL/2 compatible color printer.

Press **(x1)** after each modification.

Note The following color assignments are valid for HPGL/2 compatible color printers only. When using word processor or graphics presentation programs, different colors may be assigned to the pen numbers.

Table 4-2. Default Pen Numbers and Corresponding Colors

Pen Number	Color
0	white
1	cyan
2	magenta
3	blue
4	yellow
5	green
6	red
7	black

Table 4-3. Default Pen Numbers for Plot Elements

Corresponding Key	Plot Element	Channel 1 Pen Numbers	Channel 2 Pen Numbers
PEN NUM DATA	Measurement Data Trace	2	3
PEN NUM MEMORY	Displayed Memory Trace	5	6
PEN NUM GRATICULE	Graticule and Reference Line	1	1
PEN NUM TEXT	Displayed Text	7	7
PEN NUM MARKER	Displayed Markers and Values	7	7

Note You can set all the pen numbers to black for a plot in black and white.

You must define the pen numbers for each measurement channel (channel 1 and channel 2).

Selecting Line Types

5. Press **MORE** and select each plot element line type that you want to modify.
 - Select **LINE TYPE DATA** to modify the line type for the data trace. Then enter the new line type (see Figure 4-5), followed by **(x1)**.
 - Select **LINE TYPE MEMORY** to modify the line type for the memory trace. Then enter the new line type (see Figure 4-5), followed by **(x1)**.

Table 4-4. Default Line Types for Plot Elements

Plot Elements	Channel 1 Line Type Numbers	Channel 2 Line Type Numbers
Data Trace	7	7
Memory Trace	7	7

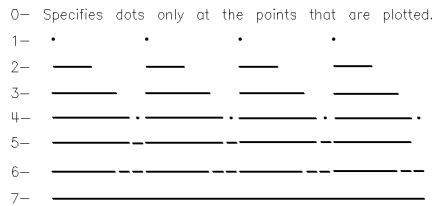

pg6135d

Figure 4-5. Line Types Available

Note You must define the line types for each measurement channel (channel 1 and channel 2).

Choosing Scale

6. Press **SCALE PLOT** until the selection appears that you want.
 - Choose **SCALE PLOT [FULL]** if you want the normal scale selection for plotting. This includes space for all display annotations such as marker values and stimulus values. The entire analyzer display fits within the defined boundaries of P1 and P2 on the plotter, while maintaining the exact same aspect ratio as the display.
 - Choose **SCALE PLOT [GRAT]** if you want the outer limits of the graticule to correspond to the defined P1 and P2 scaling point on the plotter. (Intended for plotting on preprinted rectangular or polar) forms.

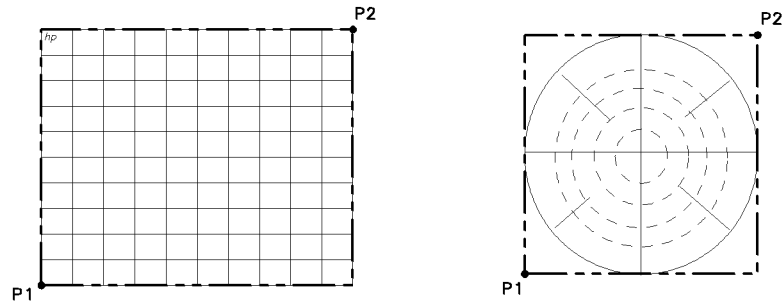

pg6157d

Figure 4-6. Locations of P1 and P2 in **SCALE PLOT [GRAT] Mode**

Choosing Plot Speed

7. Press **PLOT SPEED** until the plot speed appears that you want.
 - Choose **PLOT SPEED [FAST]** for normal plotting.
 - Choose **PLOT SPEED [SLOW]** for plotting directly on transparencies.(The slower speed provides a more consistent line width.)

To Reset the Plotting Parameters to Default Values

Press **COPY** **DEFINE PLOT** **MORE** **MORE** **DEFAULT PLOT SETUP**.

Table 4-5. Plotting Parameter Default Values

Plotting Parameter	Default
Select Quadrant	Full page
Auto Feed	ON
Define Plot	All plot elements on
Plot Scale	Full
Plot Speed	Fast
Line Type	7 (solid line)
Pen Numbers: Channel 1	
Data	2
Memory	5
Graticule	1
Text	7
Marker	7
Pen Numbers: Channel 2	
Data	3
Memory	6
Graticule	1
Text	7
Marker	7

Plotting One Measurement Per Page Using a Pen Plotter

1. Configure and define the plot, as explained in “Configuring a Plot Function” and “Defining a Plot Function” located earlier in this chapter.
2. Press **COPY** **PLOT**.
 - If you defined the **AUTO-FEED OFF**, press **PLOTTER FORM FEED** after the message **COPY OUTPUT COMPLETED** appears.

Plotting Multiple Measurements Per Page Using a Pen Plotter

1. Configure and define the plot, as explained in “Configuring a Plot Function” and “Defining a Plot Function” located earlier in this chapter.
2. Press **(COPY) SEL QUAD**.
3. Choose the quadrant where you want your displayed measurement to appear on the hardcopy. The following quadrants are available:
 - LEFT UPPER**
 - LEFT LOWER**
 - RIGHT UPPER**
 - RIGHT LOWER**

The selected quadrant will appear in the brackets under **SEL QUAD**.

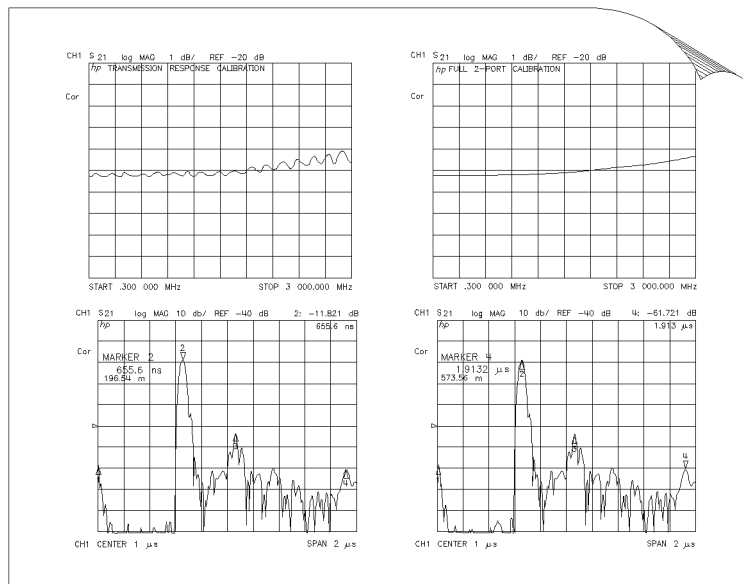

pg65e

Figure 4-7. Plot Quadrants

4. Press **PLOT**.
5. Make the next measurement that you want to see on your hardcopy.
6. Press **(COPY) SEL QUAD** and choose another quadrant where you want to place the displayed measurement.
7. Repeat the previous three steps until you have captured the results of up to four measurements.

If You are Plotting to an HPGL Compatible Printer

1. Configure and define the plot, as explained in “Configuring a Plot Function” and “Defining a Plot Function” located earlier in this chapter.
2. Press **(COPY) PLOT PLOTTER FORM FEED** to print the data the printer has received.

Hint

Use test sequencing to automatically plot all four S-parameters.

1. Set all measurement parameters.
2. Perform a full 2-port calibration.
3. Enter the test sequence:

(SEQ) NEW SEQ/MODIFY SEQ SEQUENCE 1 SEQ1

(MEAS) Ref1: FWD S11 (A/R)

(COPY) SEL QUAD LEFT UPPER PLOT

(MEAS) Trans: FWD S21 (B/R)

(COPY) SEL QUAD LEFT LOWER PLOT

(MEAS) Ref1: REV S22 (B/R)

(COPY) SEL QUAD RIGHT UPPER PLOT

(MEAS) Trans: REV S12 (B/R)

(COPY) SEL QUAD RIGHT LOWER PLOT

(SEQ) DONE SEQ MODIFY

4. Run the test sequence by pressing:

(SEQ) DO SEQUENCE SEQUENCE 1 SEQ1

Plotting a Measurement to Disk

The plot files that you generate from the analyzer, contain the HPGL representation of the measurement display. The files will not contain any setup or formfeed commands.

1. Configure the analyzer to plot to disk.
 - a. Press **(LOCAL) SET ADDRESSES PLOTTER PORT DISK**.
 - b. Press **(SAVE/RECALL) SELECT DISK** and select the disk drive that you will plot to.
 - Choose **INTERNAL DISK** if you will plot to the analyzer internal disk drive.
 - Choose **EXTERNAL DISK** if you will plot to a disk drive that is external to the analyzer. Then configure the disk drive as follows:
 - i. Press **CONFIGURE EXT DISK ADDRESS: DISK** and enter the HP-IB address to the disk drive (default is 00) followed by **(x1)**.
 - ii. Press **(LOCAL) DISK UNIT NUMBER** and enter the drive where your disk is located, followed by **(x1)**.
 - iii. If your storage disk is partitioned, press **VOLUME NUMBER** and enter the volume number where you want to store the instrument state file.
2. Press **(COPY) PLOT**.

The analyzer assigns the first available default filename for the displayed directory. For example, the analyzer would assign PLOT00FP for a LIF format (PLOT00.FP for a DOS format) if there were no previous plot files saved to the disk.

The figure below shows the three parts of the file name that is generated automatically by the analyzer whenever a plot is requested. The two digit sequence number is incremented by one each time a file with a default name is added to the directory.

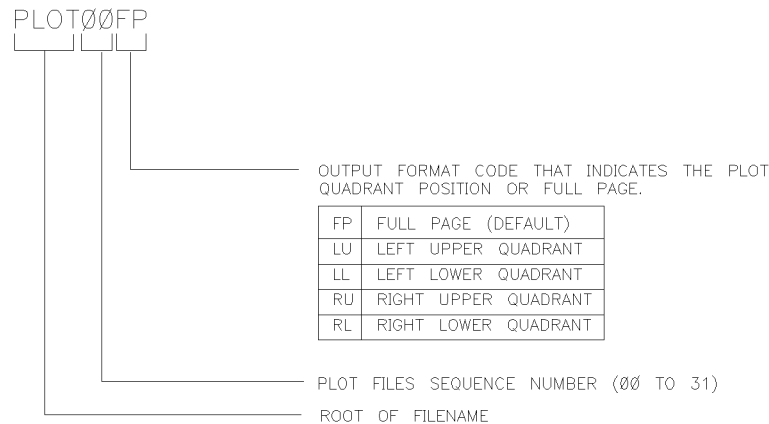

ph648c

Figure 4-8. Automatic File Naming Convention for LIF Format

To Output the Plot Files

- You can plot the files to a plotter from a personal computer.
- You can output your plot files to an HPGL compatible printer, by following the sequence in “Outputting Plot Files from a PC to an HPGL Compatible Printer” located later in this chapter.
- You can run a program that plots all of the files, with the root filename of PLOT, to an HPGL compatible printer. This program is provided on the “Example Programs Disk” that is included in the *HP 8753D Network Analyzer Programmer’s Guide*. However, this program is for use with LIF formatted disks and is written in HP BASIC.

To View Plot Files on a PC

Plot files can be viewed and manipulated on a PC using a word processor or graphics presentation program. Plot files contain a text stream of HPGL (Hewlett-Packard Graphics Language) commands. In order to import a plot file into an application, that application *must* have an import filter for HPGL (often times call HGL). Two such applications from the Lotus® suite of products are the word processor “AmiPro” and the graphics presentation package “Freelance Graphics.”

Note Lotus applications are not supported by Hewlett-Packard. The following procedures are provided for informational use only. Other applications or other versions of the same application may function differently.

When viewed in such programs, the color and font size of the plot may vary from the output of an HPGL/2 compatible color printer. The following table shows the differences between the color assignments of HPGL/2 compatible printers and Lotus applications. Also refer to “Selecting Pen Numbers and Colors” located earlier in this chapter.

HPGL/2 Printer		Lotus Applications	
Pen No.	Color	Pen No.	Color
0	white		
1	cyan (aqua)	1	black
2	magenta (red-violet)	2	red
3	blue	3	green
4	yellow	4	yellow
5	green	5	blue
6	red	6	red-violet (magenta)
7	black	7	aqua (cyan)

To modify the color or font size, consult the documentation for the particular application being used.

Using AmiPro

To view plot files in AmiPro, perform the following steps:

1. From the FILE pull-down menu, select IMPORT PICTURE.
2. In the dialog box, change the File Type selection to HPGL. This automatically changes the file suffix in the filename box to *.PLT.

Note The network analyzer does not use the suffix *.PLT, so you may want to change the filename filter to *.* or some other pattern that will allow you to locate the files you wish to import.

3. Click OK to import the file.
4. The next dialog box allows you to select paper type, rotation (landscape or portrait), and pen colors. You will probably need to change pen colors.

Note The network analyzer uses pen 7 for text. The default color in Ami Pro for pen 7 is aqua, which is not very readable against the typical white background. You may want to change pen 7 to black.

5. After all selections have been made, the file is imported and rendered in a small graphics frame which can be sized to the page by grabbing one of the nodes and stretching the box as required.
 - You will notice that the annotation around the display is not optimum, as the Ami Pro filter does not accurately import the HPGL command to render text.

Using Freelance

To view plot files in Freelance, perform the following steps:

1. From the FILE pull-down menu, select IMPORT.
2. Set the file type in the dialog box to HGL.

Note The network analyzer does not use the suffix *.HGL, so you may want to change the filename filter to *.* or some other pattern that will allow you to locate the files you wish to import.

3. Click OK to import the file.
 - You will notice that when the trace is displayed, the text annotation will be illegible. You can easily fix this with the following steps:
 - a. From the TEXT pull-down menu select FONT.
 - b. Select the type face and size. (Fourteen point text is a good place to start.)
 - c. Click OK to resize the font.
 - If you wish to modify the color of the displayed text, perform the following steps:
 - a. From the ARRANGE pull-down menu select UNGROUP.
 - b. Highlight a piece of text.
 - c. From the STYLE pull-down menu select ATTRIBUTES.
 - d. Select the desired text color and click OK.
 - e. Repeat steps b through d for each piece of text.

Outputting Plot Files from a PC to a Plotter

1. Connect the plotter to an output port of the computer (for example, COM1).
2. If using the COM1 port, output the file to the plotter by using the following command:

```
C:> TYPE PLOT00.FP > COM1
```

Outputting Plot Files from a PC to an HPGL Compatible Printer

To output the plot files to an HPGL compatible printer, you can use the HPGL initialization sequence linked in a series as follows:

- Step 1. Store the HPGL initialization sequence in a file named `hpglinit`.
- Step 2. Store the exit HPGL mode and form feed sequence in a file named `exithpgl`.
- Step 3. Send the HPGL initialization sequence to the printer.
- Step 4. Send the plot file to the printer.
- Step 5. Send the exit HPGL mode and form feed sequence to the printer.

Step 1. Store the HPGL initialization sequence.

1. Create a test file, by typing in each character as shown in the left hand column of Table 4-6. Do not insert spaces or linefeeds. Most editors allow the inclusion of escape sequences.

For example, in the MS-DOS editor (DOS 5.0 or greater), press CNTRL-P (hold down the CTRL key and press P) followed by the ESCape key to create the escape character.
2. Name the file `hpglinit`.

Table 4-6. HPGL Initialization Commands

Command	Remark
<code><esc>E</code>	conditional page eject
<code><esc>&12A</code>	page size 8.5 x 11
<code><esc>&11O</code>	landscape orientation (lower case 1, one, capital O)
<code><esc>&a0L</code>	no left margin (a, zero, capitol L)
<code><esc>&a400M</code>	no right margin (a, 4, zero, zero, capitol M)
<code><esc>&l0E</code>	no top margin (lower case 1, zero, capitol E)
<code><esc>*c7680x5650Y</code>	frame size 10.66"x 7.847" (720 decipoints/inch)
<code><esc>*p50x50Y</code>	move cursor to anchor point
<code><esc>*c0T</code>	set picture frame anchor point
<code><esc>*r-3U</code>	set CMY palette
<code><esc>%1B</code>	enter HPGL mode; cursor at PCL

Note As shown in Table 4-6, the `<esc>` is the symbol used for the escape character, decimal value 27.

Step 2. Store the exit HPGL mode and form feed sequence.

1. Create a test file by typing in each character as shown in the left hand column of Table 4-7. Do not insert spaces or linefeeds.
2. Name the file `exithpgl`.

Table 4-7. HPGL Test File Commands

Command	Remark
<code><esc>%0A</code>	exit HPGL mode
<code><esc>E</code>	form feed

Step 3. Send the HPGL initialization sequence to the printer.

Step 4. Send the plot file to the printer.

Step 5. Send the exit HPGL mode and form feed sequence to the printer.

Outputting Single Page Plots Using a Printer

You can output plot files to an HPGL compatible printer, using the DOS command line and the files created in the previous steps. This example assumes that the escape sequence files and the plot files are in the current directory and the selected printer port is PRN.

Command	Remark
<code>C:></code>	<code>type hpglinit > PRN</code>
<code>C:></code>	<code>type PLOT00.FP > PRN</code>
<code>C:></code>	<code>type exithpgl > PRN</code>

Outputting Multiple Plots to a Single Page Using a Printer

Refer to the “Plotting Multiple Measurements Per Page Using a Disk Drive,” located earlier in this chapter, for the naming conventions for plot files that you want printed on the same page. You can use the following batch file to automate the plot file printing. This batch file must be saved as “do_plot.bat.”

```
rem _____
rem Name: do_plot
rem
rem Description:
rem
rem output HPGL initialization sequence to a file:spooler
rem append all the requested plot files to the spooler
rem append the formfeed sequence to the spooler
rem copy the file to the printer
rem
rem (This routine uses COPY instead of PRINT because COPY
rem will not return until the action is completed. PRINT
rem will queue the file so the subsequent DEL will likely
rem generate an error. COPY avoids this.)
rem _____

echo off
type hpglinit > spooler
for %%i in (%1) do type %%i >> spooler
type exithpgl >> spooler
copy spooler LPT1
del spooler
echo on
```

For example, you have the following list of files to plot:

```
PLOT00.LL
PLOT00.LU
PLOT00.RL
PLOT00.RU
```

You would invoke the batch print as follows:

```
C:> do_plot PLOT00.*
```

Plotting Multiple Measurements Per Page From Disk

The following procedures show you how to store plot files on a LIF formatted disk. A naming convention is used so you can later run an HP BASIC program on an external controller that will output the files to the following peripherals:

- a plotter with auto-feed capability, such as the HP 7550B
- an HP-GL/2 compatible printer, such as the LaserJet 4 series (monochrome) or the DeskJet 1200C or DeskJet 1600C (color)

The program is contained on the “Example Programs Disk” that is provided with the *HP 8753D Network Analyzer Programmer’s Guide*. The file naming convention allows the program to initiate the following:

- to initialize the printer for HP-GL/2 at the beginning of a page
- to plot multiple plot files on the same page
- to send a page eject (form feed) to the hardcopy device, when all plots to the same page have been completed

The plot file name is made up of four parts, the first three are generated automatically by the analyzer whenever a plot is requested. The two digit sequence number is incremented by one each time a file with a default name is added to the directory.

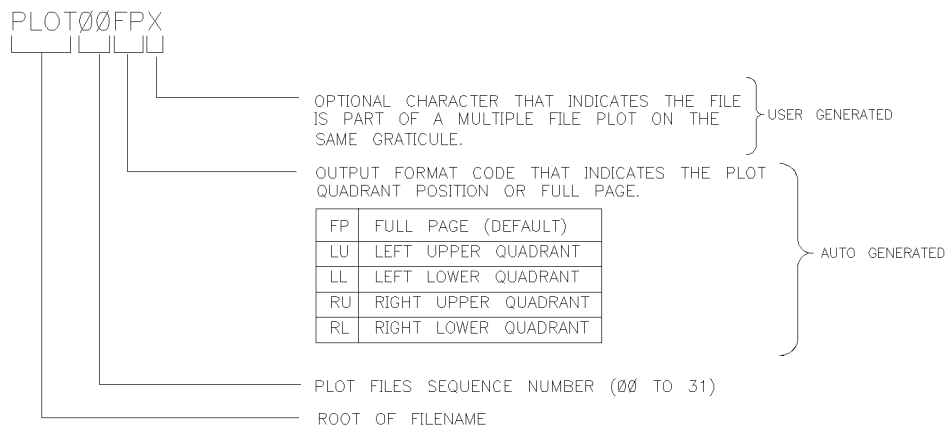

ph646c

Figure 4-9. Plot Filename Convention

To Plot Multiple Measurements on a Full Page

You may want to plot various files to the same page, for example, to show measurement data traces for different input settings, or parameters, on the same graticule.

1. Define the plot, as explained in “Defining the Plot Function” located earlier in this chapter.
2. Press **(COPY) PLOT**. The analyzer assigns the first available default filename for the displayed directory. For example, the analyzer would assign PLOT00FP if there were no previous plot files on the disk.
3. Press **(SAVE/RECALL)** and turn the front panel knob to high-light the name of the file that you just saved.
4. Press **FILE UTILITIES RENAME FILE** and turn the front panel knob to place the ↑ pointer to the A character.

5. Press **SELECT LETTER DONE**.
6. Define the next measurement plot that you will be saving to disk.
For example, you may want only the data trace to appear on the second plot for measurement comparison. In this case, you would press **(COPY) DEFINE PLOT** and choose **PLOT DATA ON PLOT MEM OFF PLOT GRAT OFF PLOT TEXT OFF PLOT MKR OFF**.
7. Press **(COPY) PLOT**. The analyzer will assign PLOT00FP because you renamed the last file saved.
8. Press **(SAVE/RECALL)** and turn the front panel knob to high-light the name of the file that you just saved.
9. Press **FILE UTILITIES RENAME FILE** and turn the front panel knob to place the ↑ pointer to the B character.
10. Press **SELECT LETTER DONE**.
11. Continue defining plots and renaming the saved file until you have saved all the data that you want to put on the same page. Renaming the files as shown below allows you to use the provided program, that organizes and plots the files, according to the file naming convention.

Plot File	Recognized Filename
First File Saved	PLOT00FPA
Second File Saved	PLOT00FPB
Third File Saved	PLOT00FPC
Fourth File Saved	PLOT00FPD

The figure below shows plots for both the frequency and time domain responses of the same device.

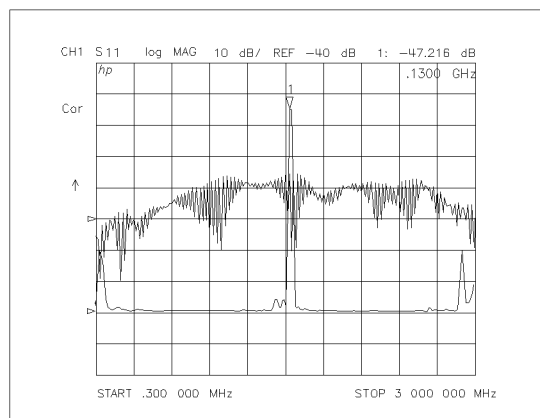

ph647c

Figure 4-10. Plotting Two Files on the Same Page

To Plot Measurements in Page Quadrants

1. Define the plot, as explained in “Defining the Plot Function” located earlier in this chapter.
2. Press **COPY** **SEL QUAD**.
3. Choose the quadrant where you want your displayed measurement to appear on the hardcopy. The selected quadrant appears in the brackets under **SEL QUAD**.

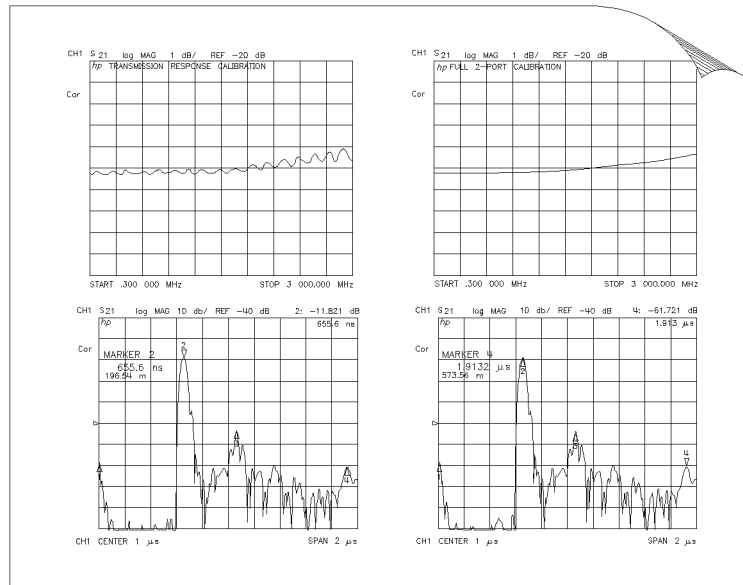

pg65e

Figure 4-11. Plot Quadrants

4. Press **PLOT**. The analyzer assigns the first available default filename for the selected quadrant. For example, the analyzer would assign PLOT01LU if there were no other left upper quadrant plots on the disk.
5. Make the next measurement that you want to see on your hardcopy.
6. Repeat this procedure for the remaining plot files that you want to see as quadrants on a page. If you want to see what quadrants you have already saved, press **SAVE/RECALL** to view the directory.

Titling the Displayed Measurement

You can create a title that is printed or plotted with your measurement result.

1. Press **DISPLAY** **MORE** **TITLE** to access the title menu.
2. Press **ERASE TITLE**.
3. Turn the front panel knob to move the arrow pointer to the first character of the title.
4. Press **SELECT LETTER**.
5. Repeat the previous two steps to enter the rest of the characters in your title. You can enter a title that has a maximum of 50 characters. Press **BACK SPACE** if you enter an incorrect character.
6. Press **DONE** to complete the title entry.

Note Titles may also be entered using the optional external keyboard.

Caution The **NEWLINE** and **FORMFEED** keys are not intended for creating display titles. Those keys are for creating commands to send to peripherals during a sequence program.

Configuring the Analyzer to Produce a Time Stamp

You can set a clock, and then activate it, if you want the time and date to appear on your hardcopies.

1. Press **(SYSTEM) SET CLOCK**.
2. Press **SET YEAR** and enter the current year (four digits), followed by **(x1)**.
3. Press **SET MONTH** and enter the current month of the year, followed **(x1)**.
4. Press **SET DAY** and enter the current day of the month, followed by **(x1)**.
5. Press **SET HOUR** and enter the current hour of the day (0-23), followed by **(x1)**.
6. Press **SET MINUTES** and enter the next immediate minute, followed by **(x1)**.
7. Press **ROUND SECONDS** when the current time is exactly as you have set it.
8. Press **TIME STAMP** until **TIME STAMP ON** appears on the softkey label.

Aborting a Print or Plot Process

1. Press the **(LOCAL)** key to stop all data transfer.
2. If your peripheral is not responding, press **(LOCAL)** again or reset the peripheral.

Printing or Plotting the List Values or Operating Parameters

Press **(COPY) LIST** and select the information that you want to appear on your hardcopy.

- Choose **LIST VALUES** if you want a tabular listing of the measured data points, and their current values, to appear on your hardcopy. This list will also include the limit test information, if you have the limits function activated.
- Choose **OP PARMS (MKRS etc)** if you want a tabular listing of the parameters for both measurement channels to appear on your hardcopy. The parameters include: operating parameters, marker parameters, and system parameters that relate to the control of peripheral devices.

If You want a Single Page of Values

1. Choose **PRINT MONOCHROME** for a printer or **PLOT** for a plotter peripheral, to create a hardcopy of the displayed page of listed values.
2. Press **NEXT PAGE** to display the next page of listed values. Press **PREVIOUS PAGE** to display the previous page of listed values. Or, you can press **NEXT PAGE** or **PREVIOUS PAGE** repeatedly to display a particular page of listed values that you want to appear on your hardcopy. Then repeat the previous step to create the hardcopy.

3. Repeat the previous two steps until you have created hardcopies for all the desired pages of listed values.

If you are printing the list of measurement data points, each page contains 30 lines of data. The number of pages is determined by the number of measurement points that you have selected under the **(MENU)** key.

If You Want the Entire List of Values

Choose **PRINT ALL** to print all pages of the listed values.

Note If you are printing the list of operating parameters, only the first four pages are printed. The fifth page, system parameters, is printed by displaying that page and then pressing **PRINT**.

Solving Problems with Printing or Plotting

If you encounter a problem when you are printing or plotting, check the following list for possible causes:

- Look in the analyzer display message area. The analyzer may show a message that will identify the problem. Refer to the “Error Messages” chapter if a message appears.
- If necessary, refer to the configuration procedures in this chapter to check that you have done the following:
 - connected an interface cable between the peripheral and the analyzer
 - connected the peripheral to ac power
 - switched on the power
 - switched the peripheral on line
 - selected the correct printer or plotter type
- If you are using a laser printer for plotting, and the printer is outputting partial plots, the printer may require more memory and/or the page protection activated.

Note Consult your printer manual for information on upgrading memory and how to activate page protection.

- Make sure that the analyzer address setting for the peripheral corresponds to the actual HP-IB address of the peripheral. The procedure is explained earlier in this chapter.
- Make sure that the analyzer is in system controller mode, by pressing **(LOCAL)** **SYSTEM CONTROLLER**, if the analyzer is not connected to an external controller. Otherwise, the analyzer must be in the pass control mode.
- Substitute the interface cable.
- Substitute a different printer or plotter.

Saving and Recalling Instrument States

Places Where You Can Save

- analyzer internal memory
- floppy disk using the analyzer's internal disk drive
- floppy disk using an external disk drive
- IBM compatible personal computer using HP-IB mnemonics

What You Can Save to the Analyzer's Internal Memory

The number of registers that the analyzer allows you to save depends on the size of associated error-correction sets, and memory traces. Refer to the "Preset State and Memory Allocation" chapter for further information.

You can save instrument states in the analyzer internal memory, along with the following list of analyzer settings. The default filenames are REG<01-31>.

- error-corrections on channels 1 and 2
- displayed memory trace
- print/plot definitions
- measurement setup
 - frequency range
 - number of points
 - sweep time
 - output power
 - sweep type
 - measurement parameter

Note When the ac line power is switched off, the internal non-volatile memory is retained by a battery. The data retention time with the 3 V, 1.2 Ah battery is as follows:

Temperature at 70 °C	250 days (0.68 year) characteristically
Temperature at 40 °C	1244 days (3.4 years) characteristically
Temperature at 25 °C	10 years characteristically

What You Can Save to a Floppy Disk

You can save an instrument state and/or measurement results to a disk. The default filenames are FILEn, where n gets incremented by one each time a file with a default name is added to the directory. The default filenames for data-only files are DATAnDn (DATAn.Dn for DOS), where the first n is incremented by one each time a file with a default name is added to the directory. The second n is the channel where the measurement was made. When you save a file to disk, you can choose to save some or all of the following:

- all settings listed above for internal memory
- active error-correction for the active channel only
- displayed measurement data trace
- displayed user graphics
- data only
- HPGL plots

What You Can Save to a Computer

Instrument states can be saved to and recalled from an external computer (system controller) using HP-IB mnemonics. For more information about the specific analyzer settings that can be saved, refer to the output commands located in the “Command Reference” chapter of the *HP 8753D Network Analyzer Programmer’s Guide*. For an example program, refer to “Saving and Recalling Instruments States” in the “Programming Examples” chapter of the *HP 8753D Network Analyzer Programmer’s Guide*.

Saving an Instrument State

1. Press **(SAVE/RECALL) SELECT DISK** and select one of the storage devices:
 - INTERNAL MEMORY**
 - INTERNAL DISK**
 - EXTERNAL DISK** and then configure as follows:
 - a. Connect an external disk drive to the analyzer's HP-IB connector, and configure as follows:
 - b. Press **(LOCAL) DISK UNIT NUMBER** and enter the drive where your disk is located, followed by **(x1)**.
 - c. If your storage disk is partitioned, press **VOLUME NUMBER** and enter the volume number where you want to store the instrument state file.
 - d. Press **SET ADDRESSES ADDRESS: DISK**.
 - e. Enter the HP-IB address of the peripheral, if the default address is incorrect (default = 00). Follow the entry by pressing **(x1)**.
 - f. Press **(LOCAL)** and select one of the following:
 - Choose **SYSTEM CONTROLLER** to allow the analyzer to control peripherals directly.
 - Choose **TALKER/LISTENER** to allow the computer controller to be involved in all peripheral access operations.
 - Choose **USE PASS CONTROL** to allow yourself to control the analyzer over HP-IB and also allows the analyzer to take or pass control.
2. Press **(SAVE/RECALL) SAVE STATE**.

The analyzer saves the state in the next available register, if you are saving to internal memory, or saves the state to disk. Although one file is shown to represent an instrument state on the analyzer display, each instrument state is composed of numerous files (which can be viewed on a PC).

Note

If you have saved enough files that you have used all the default names (FILE00 - FILE31 for disk files, or REG1 - REG31 for memory files), you must do one of the following in order to save more states:

- use another disk
 - rename an existing file to make a default name available
 - re-save a file/register
 - delete an existing file/register
-

Saving Measurement Results

Instrument states combined with measurements results can only be saved to disk. Files that contain data-only, and the various save options available under the `DEFINE DISK SAVE` key, are also only valid for disk saves.

The analyzer stores data in arrays along the processing flow of numerical data, from IF detection to display. These arrays are points in the flow path where data is accessible, usually via HP-IB. You can choose from three different arrays which vary in modification flexibility when they are recalled.

- raw data
- data (raw data with error-correction applied)
- format (data processed to the display format)

If you choose to save the raw data array, you will have the most flexibility in modifying the recalled measurement (including the ability to view all four S-parameters). This is because the raw data array has the least amount of processing associated with it. Conversely, if you choose to save the format array, your modification of the recalled measurement will be limited by all the processes that are associated with that measurement result. However, the format array is appropriate if you want to retrieve data traces that look like the currently displayed data.

Define Save	Modification Flexibility During Recall
Raw Data Array	Most
Data Array	Medium
Format Array	Least

You can also save data-only. This is saved to disk with default filenames DATA00D1 to DATA31D1, for channel 1, or DATA00D2 to DATA31D2, for channel 2. However, these files are not instrument states and cannot be recalled.

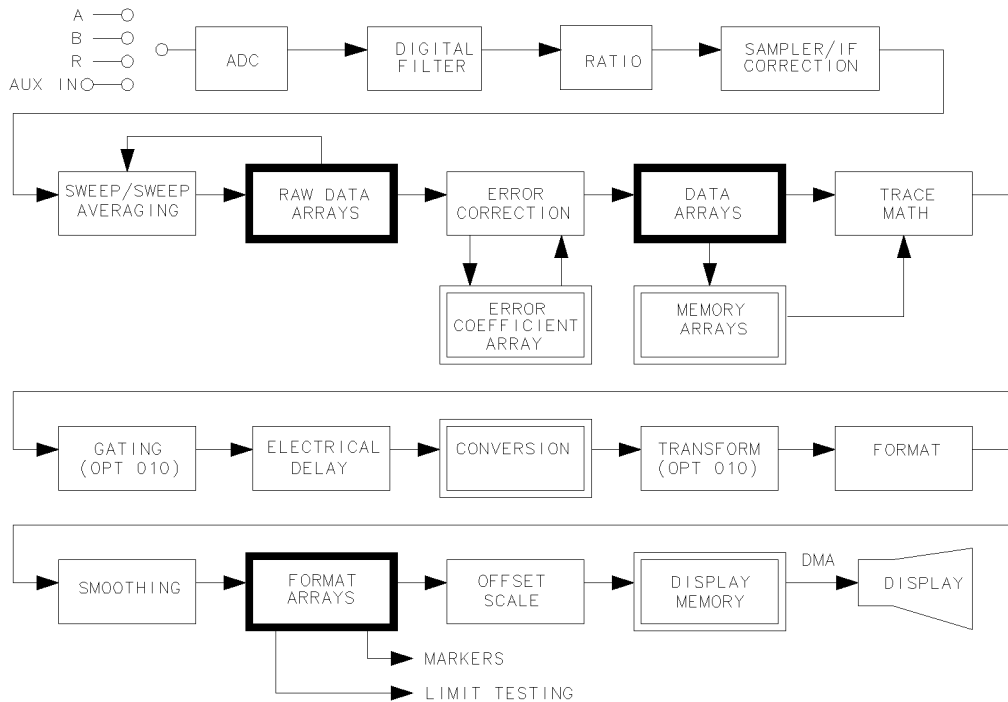

pg624d

Figure 4-12. Data Processing Flow Diagram

Note If the analyzer has an active two-port measurement calibration, all four S-parameters will be saved with the measurement results. All four S-parameters may be viewed if the raw data array has been saved.

1. If you want to title the displayed measurement, refer to “Titling the Displayed Measurement,” located earlier in this chapter.
2. Press **(SAVE/RECALL) SELECT DISK**.
3. Choose one of the following disk drives:
 - **INTERNAL DISK**
 - **EXTERNAL DISK** and then configure as follows:
 - a. Connect an external disk drive to the analyzer’s HP-IB connector, and configure as follows:
 - b. Press **(LOCAL) DISK UNIT NUMBER** and enter the drive where your disk is located, followed by **(x1)**.
 - c. If your storage disk is partitioned, press **VOLUME NUMBER** and enter the volume number where you want to store the instrument state file.
 - d. Press **SET ADDRESSES ADDRESS: DISK**.
 - e. Enter the HP-IB address of the peripheral, if the default address is incorrect (default = 00). Follow the entry by pressing **(x1)**.

- f. Press **LOCAL** and select one of the following:
- Choose **SYSTEM CONTROLLER** to allow the analyzer to control peripherals directly.
 - Choose **TALKER/LISTENER** to allow the computer controller to be involved in all peripheral access operations.
 - Choose **PASS CONTROL** to allow yourself to control the analyzer over HP-IB and also allows the analyzer to take or pass control.
4. Press **SAVE/RECALL** **DEFINE DISK-SAVE**.

5. Define the save by selecting one of the following choices:

- DATA ARRAY ON**
- RAW ARRAY ON**
- FORMAT ARRAY ON**
- GRAPHICS ON**
- DATA ONLY ON** (see note below)

If you select **DATA ARRAY ON**, **RAW ARRAY ON**, or **FORMAT ARRAY ON**, the data is stored to disk in IEEE-64 bit real format (for LIF disks), and 32 bit PC format for DOS disks. This makes the DOS data files half the size of the LIF files.

Note Selecting **DATA ARRAY ON** may store data to disk in the S2P ASCII data format. See “ASCII Data Formats.”

If you select **GRAPHICS ON**, the user graphics area is saved. (Refer to the *HP 8753D Network Analyzer Programmer's Guide* for information on using display graphics.) The measurement display is not saved with this selection. (Refer to the information located earlier in this chapter for a procedure that shows you how to plot measurement displays to disk.)

Note Selecting **DATA ONLY ON** will override all of the other save options. Because this type of data is only intended for computer manipulation, the file contents of a **DATA ONLY ON** save cannot be recalled and displayed on the analyzer.

6. Choose the type of format you want:

- Choose **SAVE USING BINARY** for all applications except CITIfile, S2P, or CAE applications.
- Choose **SAVE USING ASCII** for CITIfile, S2P, and CAE applications or when you want to import the information into a spread sheet format.

7. Press **RETURN** **SAVE STATE**.

ASCII Data Formats

CITIfile

CITIfile (Common Instrumentation Transfer and Interchange file) is an ASCII data format that is useful when exchanging data between different computers and instruments. For more information on the CITIfile data format as well as a list of CITIfile keywords, refer to Appendix A, “The CITIfile Data Format and Keyword Reference.”

S2P Data Format

Component data files contain small signal S-parameters described by frequency dependent linear network parameters for 2 port components. These files are assigned a filename with the suffix S1 or S2 depending on which measurement channel generated the data. These files are output only. (They cannot be read in by the analyzer.)

An S2P file is output only when the user has either a full 2-port or TRL 2-port error correction turned on, and has selected it under **SAVE/RECALL**:

```
DEFINE DISK-SAVE
DATA ARRAY ON or DATA ONLY ON
SAVE USING ASCII
SAVE STATE
```

The template for component data files is as follows:

```
! comment line
# <frequency units> <parameter> <format> <Rn>
<data line>
...
<data line>
```

where

!	indicates that all following on this line is a comment
#	indicates that entries following on this line are parameters that are being specified
frequency units	GHz, MHz, kHz, Hz
parameter	S for S-parameters
format	DB for dB magnitude and angle in degrees MA for linear magnitude and angle in degrees RI for real and imaginary pair
Rn	the reference impedance in ohms for the analyzer making the measurement (R 50 or R 75)

The “format” above is selected by the current selection under the FORMAT menu. To select the DB format, the FORMAT must be LOG MAG. For MA, the FORMAT must be LIN MAG, and all other FORMAT selections will output RI data. The S2P data will always represent the format array data, including effects of electrical delay and port extensions. A CITI file will be saved at the same time. To be consistent with previous versions, the CITI file data saved will represent the DATA array (corrected data) without effects of electrical delay or port extensions.

Here is an S2P example file for an 21 point measurement of a 20 dB attenuator:

```
! Network Analyzer HP 8753D.06.11 Serial No. US31240052
! <Title line for current channel>
! 23 May 1997 15:26:54
# HZ S DB R 50

50000000 -56.404 -145.38 -.0083 -.3337 -.0079 -.1606 -58.034 5.0084
1050000000 -68.761 -65.356 .0142 .0137 .0042 .1043 -64.085 -83.573
2050000000 -64.108 41.723 .0253 .0068 .0147 .1675 -61.954 -173.75
3050000000 -60.125 119.38 .0358 0.0 .0279 .1455 -60.338 56.346
4050000000 -61.224 -32.686 .0474 -.0137 .0384 .1249 -61.743 169.73
5050000000 -59.429 38.486 .0596 -.0494 .0448 .0700 -55.876 156.44
6050000000 -56.035 70.648 .0681 -.0975 .0553 .0315 -63.449 39.47
7050000000 -54.229 88.746 .0749 -.1139 .0633 -.0068 -55.804 30.247
8050000000 -61.411 111.97 .0802 -.1977 .0712 -.0521 -51.102 97.546
9050000000 -52.49 103.21 .0828 -.2952 .0764 -.1249 -52.406 126.36
10050000000 -64.291 35.461 .0875 -.3213 .0775 -.2252 -59.417 85.038
11050000000 -52.096 46.505 .0918 -.4298 .0770 -.2774 -48.868 68.46
12050000000 -49.648 78.573 .0878 -.5232 .0787 -.3364 -50.699 77.157
13050000000 -48.431 25.793 .0805 -.5616 .0751 -.4229 -48.461 60.445
14050000000 -45.984 36.612 .0717 -.6097 .0651 -.4202 -44.971 37.711
15050000000 -52.703 -9.3823 .0748 -.6001 .0614 -.3749 -46.822 -23.128
16050000000 -50.548 -63.182 .0863 -.5685 .0849 -.3364 -53.049 11.283
17050000000 -57.776 19.931 .0973 -.5877 .0971 -.4229 -48.105 -34.254
18050000000 -56.256 -98.687 .1022 -.7045 .0993 -.5081 -54.446 -67.992
19050000000 -76.33 149.78 .0965 -.7635 .1004 -.5644 -48.489 48.591
20050000000 -59.269 163.78 .1050 -.7951 .1078 -.6083 -44.865 2.8304
```

Re-Saving an Instrument State

If you re-save a file, the analyzer overwrites the existing file contents.

Note You cannot re-save a file that contains data only. You must create a new file.

1. Press **SAVE/RECALL** **SELECT DISK** and select the storage device.
 - INTERNAL MEMORY**
 - INTERNAL DISK**
 - EXTERNAL DISK**
2. Press **RETURN** and then use the **↓** **↑** keys or the front panel knob to high-light the name of the file that you want to re-save.
3. Press **RE-SAVE STATE** **YES**.

Deleting a File

1. Press **SAVE/RECALL** **SELECT DISK**.
2. Choose from the following storage devices:
 - INTERNAL MEMORY**
 - INTERNAL DISK**
 - EXTERNAL DISK**
3. Press **RETURN**.

To Delete an Instrument State File

- Press the **↓** **↑** keys or the front panel knob to high-light the name of the file that you want to delete.
- Press **FILE UTILITIES** **DELETE FILE** **YES** to delete all of the files that make up the selected instrument state.

To Delete all Files

- Press **FILE UTILITIES** **DELETE ALL FILES** **YES** to delete all of the files that are on the selected storage device.

Renaming a File

1. Press **SAVE/RECALL** **SELECT DISK** .
2. Choose from the following storage devices:
 - INTERNAL MEMORY**
 - INTERNAL DISK**
 - EXTERNAL DISK**
3. Press **RETURN** and then use the **↓** **↑** keys or the front panel knob to high-light the name of the file that you want to rename.
4. Press **RETURN** **FILE UTILITIES** **RENAME FILE** **ERASE TITLE** .
5. Turn the front panel knob to point to each character of the new filename, pressing **SELECT LETTER** when the arrow points to each character. Press **BACK SPACE** if you enter an incorrect character. After you have selected all the characters in the new filename, press **DONE** .

Note Renaming files may also be done by using the optional external keyboard.

Recalling a File

1. Press **SAVE/RECALL** **SELECT DISK** .
2. Choose from the following storage devices:
 - INTERNAL MEMORY**
 - INTERNAL DISK**
 - EXTERNAL DISK**
3. Press the **↓** **↑** keys or the front panel knob to high-light the name of the file that you want to recall.
4. Press **RETURN** **RECALL STATE** .

Formatting a Disk

1. Press **(SAVE/RECALL) FILE UTILITIES FORMAT DISK**.
2. Choose the type of format you want:
 - FORMAT:LIF**
 - FORMAT:DOS**
3. Press **FORMAT EXT DISK YES**.

Solving Problems with Saving or Recalling Files

If you encounter a problem when you are storing files to disk, or the analyzer internal memory, check the following list for possible causes:

- Look in the analyzer display message area. The analyzer may show a message that will identify the problem. Refer to the “Error Messages” chapter if you view a message.
- Make sure that you are NOT using a single-sided floppy disk in the analyzer disk drive.
- Make sure that you are using a formatted disk.
- Make sure that the disk has not been formatted with the LIF-1 (hierarchical file system) extensions as the analyzer does not support this format.

If You are Using an External Disk Drive

- Make sure that the analyzer is in system controller mode, by pressing **(LOCAL) SYSTEM CONTROLLER**.
- Make sure that you have connected the disk drive to ac power, switched on the power, and connected an HP-IB cable between the disk drive and the analyzer.
- Make sure that the analyzer recognizes the disk drive’s HP-IB address, as explained earlier in this chapter.
- Make sure that the analyzer recognizes the disk (drive) unit that you selected (0 or 1).
- If the external disk is a hard disk, make sure that the disk volume number is set correctly.
- If the disk drive is an older HP 9122, it may not recognize the newer high density disks.
- Substitute the HP-IB cable.
- Substitute the disk drive.

Optimizing Measurement Results

This chapter describes techniques and analyzer functions that help you achieve the best measurement results. The following topics are included in this chapter:

- Increasing measurement accuracy
 - Connector repeatability
 - Interconnecting cables
 - Temperature drift
 - Frequency drift
 - Performance verification
 - Reference plane and port extensions
 - Measurement error-correction
 - Frequency response correction
 - Frequency response and isolation correction
 - One-port reflection correction
 - Full two-port correction
 - TRL* and TRM* error-correction
 - Modifying calibration kit standards
 - Power meter measurement calibration
 - Calibrating for noninsertable devices
 - Adapter removal
 - Matched adapters
 - Modify the cal kit thru definition
 - Maintaining testport output power during sweep retrace
 - Making accurate measurements of electrically long devices
 - Increasing sweep speed
 - Increasing dynamic range
 - Reducing trace noise
 - Reducing receiver crosstalk
 - Reducing recall time

Where to Look for More Information

Additional information about many of the topics discussed in this chapter is located in the following areas:

- Chapter 2, “Making Measurements,” contains step-by-step procedures for making measurements or using particular functions.
- Chapter 4, “Printing, Plotting, and Saving Measurement Results,” contains instructions for saving to disk or to the analyzer internal memory, and printing and plotting displayed measurements.
- Chapter 6, “Application and Operation Concepts,” contains explanatory-style information about many applications and analyzer operation.

Increasing Measurement Accuracy

Connector Repeatability

Connector repeatability is a source of random measurement error. Measurement error-corrections do not compensate for these errors. For all connectors, you should frequently do the following:

- inspect the connectors
- clean the connectors
- gauge the connectors
- use correct connection techniques (See Chapter 2, Table 2-1.)

Interconnecting Cables

Cables connecting the device under test to the analyzer can contribute random errors to your measurement. You should frequently do the following:

- inspect for lossy cables
- inspect for damaged cable connectors
- practice good connector care techniques
- minimize cable position changes between error-correction and measurements
- inspect for cables which dramatically change magnitude or phase response when flexing (This may indicate an intermittent problem.)

Temperature Drift

Electrical characteristics will change with temperature due to the thermal expansion characteristics of devices within the analyzer, calibration devices, test devices, cables, and adapters. Therefore, the operating temperature is a critical factor in their performance. During a measurement calibration, the temperature of the calibration devices must be stable and within 25 ± 5 °C.

- use a temperature-controlled environment
- ensure the temperature stability of the calibration devices
- avoid handling the calibration devices unnecessarily during calibration
- ensure the ambient temperature is ± 1 °C of measurement error-correction temperature

Frequency Drift

Minute changes in frequency accuracy and stability can occur as a result of temperature and aging (on the order of parts per million). If you require greater frequency accuracy, do the following:

- Override the internal crystal with a high-stability external source, frequency standard, or (if your analyzer is equipped with Option 1D5) use the internal frequency standard.

Performance Verification

You should periodically check the accuracy of the analyzer measurements, by doing the following:

- perform a measurement verification at least once per year

Refer to the *HP 8753D Service Guide* for the measurement verification procedure.

Reference Plane and Port Extensions

Use the port extension feature to compensate for the phase shift of an extended measurement reference plane, due to such additions as cables, adapters, and fixtures, after completing an error-correction procedure (or when there is no active correction).

Using port extensions is similar to using electrical delay. However, using port extensions is the preferred method of compensating for test fixture phase shift. Table 5-1 explains the difference between port extensions and electrical delay.

Table 5-1.
Differences between PORT EXTENSIONS and ELECTRICAL DELAY

	PORT EXTENSIONS	ELECTRICAL DELAY
Main Effect	The end of a cable becomes the test port plane for all S-parameter measurements.	Compensates for the electrical length of a cable. Set the cable's electrical length x 1 for transmission. Set the cable's electrical length x 2 for reflection.
Measurements Affected	All S-parameters.	Only the currently selected S-parameter.
Electrical Compensation	Intelligently compensates for 1 times or 2 times the cable's electrical delay, depending on which S-parameter is computed.	Only compensates for electrical length.

You can activate a port extension by pressing **(CAL) MORE PORT EXTENSIONS EXTENSIONS ON**. Then enter the delay to the reference plane.

Measurement Error-Correction

The accuracy of network analysis is greatly influenced by factors external to the network analyzer. Components of the measurement setup, such as interconnecting cables and adapters, introduce variations in magnitude and phase that can mask the actual response of the device under test.

Error-correction is an accuracy enhancement procedure that removes systematic errors (repeatable measurement variations) in the test setup. The analyzer measures known standard devices, and uses the results of these measurements to characterize the system.

Conditions Where Error-Correction is Suggested

Measurement accuracy and system characteristics can be affected by the following factors:

- Adapting to a different connector type or impedance.
- Connecting a cable between the test device and an analyzer test port.
- Connecting any attenuator or other such device on the input or output of the test device.

If your test setup meets any of the conditions above, the following system characteristics may be affected:

- amplitude at device input
- frequency response accuracy
- directivity
- crosstalk (isolation)
- source match
- load match

Types of Error-Correction

Several types of error correction are available that remove from one to twelve systematic errors. The full 2-port correction effectively removes all twelve correctable systematic errors. Some measurements do not require correction for all twelve errors. The following table explains each correction and its uses.

Table 5-2. Purpose and Use of Different Error-Correction Procedures

Correction Procedure	Corresponding Measurement	Errors Corrected	Standard Devices
Response	Transmission or reflection measurement when the highest accuracy is not required.	Frequency response.	Thru for transmission, open or short for reflection.
Response & isolation	Transmission of high insertion loss devices or reflection of high return loss devices. Not as accurate as 1-port or 2-port correction.	Frequency response plus isolation in transmission or directivity in reflection.	Same as response plus isolation standard. (load)
S_{11} 1-port	Reflection of any one-port device or well terminated two-port device.	Directivity, source match, frequency response.	Short and open and load.
S_{22} 1-port	Reflection of any one-port device or well terminated two-port device.	Directivity, source match, frequency response.	Short and open and load.
Full 2-port	Transmission or reflection of highest accuracy for two-port devices.	Directivity, source match, load match, isolation, frequency response, forward and reverse.	Short and open and load and thru. (2 loads for isolation)
TRL*/LRM*	Transmission or reflection when highest accuracy is not required.	Directivity, isolation, frequency response. (forward and reverse)	Thru, reflect, line, or line, reflect, match, or thru, reflect, match.

Note Frequency response calibration is not as accurate as other calibration methods.

Error-Correction Stimulus State

Error-correction is only valid for a specific stimulus state, which you must select before you start a correction. If you change any of the following parameters, you will invalidate the correction and the analyzer will switch the correction off (unless the interpolated error correction feature is activated):

- frequency range
- number of points
- sweep type

The error-correction quality may be degraded (Cor changes to C?), if you change the following stimulus state parameters:

- sweep time
- system bandwidth
- output power

Note If you activate averaging, the analyzer may increase the sweep time if more time is needed to calculate the averages. If the sweep time changes, you will see Cor change to C?. The number of averages does not affect a sweep cycle time. Therefore, if you use averaging for error-correction, leave it on for the measurement and set the averaging factor to 1, for a faster sweep.

Calibration Standards

The quality of the error-correction is limited by two factors: (1) the difference between the model of the calibration standards and the actual electrical characteristics of those standards, and (2) the condition of the calibration standards. To make the highest quality measurement calibration, follow the suggestions below:

- use the correct standard model
- inspect the calibration standards
- clean the calibration standards
- gauge the calibration standards
- use correct connection techniques

If you want to use calibration standards other than the default sets, you must change the standard model. (Refer to “Modifying Calibration Kit Standards” located later in this chapter.) After you enter the mathematical model for the new calibration standards, the analyzer can then use the model that corresponds to the new standards.

Compensating for the Electrical Delay of Calibration Standards

Short and open calibration standards in the 3.5 mm, 2.4 mm, and 2.92 mm connector types have a certain amount of electrical delay. The analyzer compensates for this delay by offsetting the calibration results by the total amount of electrical delay caused by the calibration standard in both the forward and reverse direction. As a result, if these standards are measured after a calibration, they will not appear to be “perfect” shorts or opens. This is an indication that *your analyzer is working properly* and that it has successfully performed a calibration.

Note If you enter the opposite amount of electrical delay that was used by the analyzer during calibration, then the short calibration standard *will* appear to be “perfect.” The open calibration standard has additional phase shift caused by fringing capacitance. See “Calibration Considerations” in Chapter 6, “Application and Operation Concepts.”

Clarifying Type-N Connector Sex

When you are performing error-correction for a system that has type-N test port connectors, the softkey menus label the sex of the test port connector - *not* the calibration standard connector. For example, the label **SHORT (F)** refers to the short that will be connected to the female *test port*.

When to Use Interpolated Error-Correction

You may want to use interpolated error-correction when you choose a subset of a frequency range that you already corrected, when you change the number of points, or when you change to CW. This feature also allows you to change the parameters in a 2-port correction, such as IF bandwidth, power, or sweep time. The analyzer calculates the systematic errors from the errors of the original correction.

The quality of the interpolated error-correction depends on the amount of phase shift and amplitude change of the error coefficients between measurement points. If the phase shift is $<180^\circ$ per five measurement points, the interpolated error-correction can be a great improvement over uncorrected measurement.

To activate interpolated measurement correction, press **CAL INTERPOL ON CORRECTION ON**. When interpolation is in use, the notation **C?** will appear on the analyzer display.

Procedures for Error-Correcting Your Measurements

This section has example procedures or information on the following topics:

- frequency response correction
- frequency response and isolation correction
- one-port reflection correction
- full two-port correction
- TRL*/LRM* correction
- modifying calibration kit standards
- power meter measurement calibration procedure

Note If you are making measurements on uncoupled measurement channels, you must make a correction for each channel.

Frequency Response Error-Corrections

You can remove the frequency response of the test setup for the following measurements.

- reflection measurements
- transmission measurements
- combined reflection and transmission measurements

Response Error-Correction for Reflection Measurements

1. Press **PRESET**.
2. Select the type of measurement you want to make.
 - If you want to make a reflection measurement on PORT 1 (in the forward direction, S_{11}), leave the instrument default setting.
 - If you want to make a reflection measurement on PORT 2 (in the reverse direction S_{22}), press:
MEAS Ref1: REV S22 (B/R)
 - Set any other measurement parameters that you want for the device measurement: power, sweep type, number of points, or IF bandwidth.
 - To access the measurement error-correction menus, press:
CAL
 - If your calibration kit is different than the kit specified under the **CAL KIT []** softkey, press:
CAL KIT **SELECT CAL KIT** (select your type of kit)
RETURN
If your type of calibration kit is not listed in the displayed menu, refer to the “Modifying Calibration Standards” procedure, located later in this chapter.
 - To select a response correction, press:
CAL **CALIBRATE MENU** **RESPONSE**
 - Connect the short or open calibration standard to the port you selected for the test port (PORT 1 for S_{11} or PORT 2 for S_{22}).

Note Include any adapters or cables that you will have in the device measurement. That is, connect the standard device to the particular connector where you will connect your device under test.

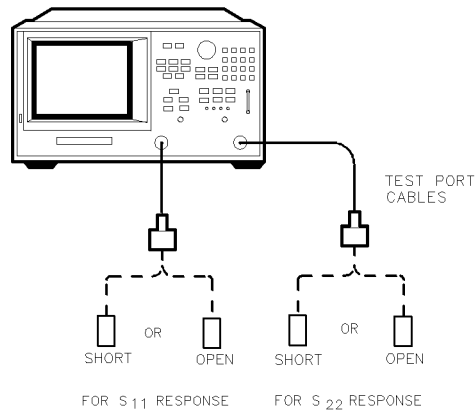

pg686d

Figure 5-1.
Standard Connections for a Response Error-Correction for Reflection Measurement

- To measure the standard when the displayed trace has settled, press:

SHORT or **OPEN**

If the calibration kit you selected has a choice between male and female calibration standards, remember to select the sex that applies to the test port and not the standard.

The analyzer displays **WAIT - MEASURING CAL STANDARD** during the standard measurement. The analyzer underlines the softkey that you selected after it finishes the measurement, and computes the error coefficients.

Note This calibration allows *only* one standard to be measured. If you press the wrong key for a standard, start over with step 6. *Do not* use a thru standard for a reflection response correction.

Note You can save or store the measurement correction to use for later measurements, that use the same measurement parameters. Refer to the “Printing, Plotting, and Saving Measurement Results” chapter for procedures.

- This completes the response correction for reflection measurements. You can connect and measure your device under test.

Response Error-Correction for Transmission Measurements

1. Press **PRESET**.
2. Select the type of measurement you want to make.
 - If you want to make a transmission measurement in the forward direction (S_{21}), press:
MEAS Trans: FWD S21 (B/R)
 - If you want to make a transmission measurement in the reverse direction (S_{12}), press:
MEAS Trans: REV S12 (A/R)
3. Set any other measurement parameters that you want for the device measurement: power, number of points, IF bandwidth.
4. To select a response correction, press:
CAL CALIBRATE MENU RESPONSE
5. Make a "thru" connection between the points where you will connect your device under test.

Note Include any adapters or cables that you will have in the device measurement. That is, connect the standard device where you will connect your device under test.

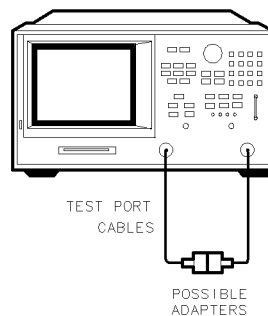

pg677d

Figure 5-2.
Standard Connections for Response Error-Correction for Transmission Measurements

6. To measure the standard, press:

THRU

The analyzer displays **WAIT - MEASURING CAL STANDARD** during the standard measurement. The analyzer underlines the **THRU** softkey after it measures the calibration standard, and computes the error coefficients.

Note *Do not* use an open or short standard for a transmission response correction.

Note You can save or store the measurement correction to use for later measurements. Refer to the “Printing, Plotting, and Saving Measurement Results” chapter for procedures.

7. This completes the response correction for transmission measurements. You can connect and measure your device under test.

Receiver Calibration

Receiver calibration provides a frequency response error-correction that also indicates absolute power in dBm. This calibration is most useful when performed with a power meter calibration.

1. Perform a power meter calibration. See “Power Meter Measurement Calibration,” located later in this chapter.
2. To set the analyzer test port power to 0 dBm, press:

MENU **POWER** **0** **x1**

3. Make a “thru” connection between the points where you will connect your device under test.

Note Include any adapters or cables that you will have in the device measurement. That is, connect the standard device where you will connect your device under test.

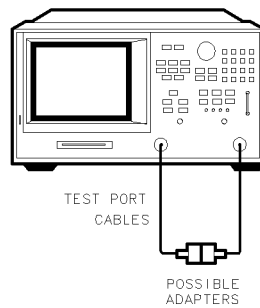

pg677d

Figure 5-3. Standard Connections for Receiver Calibration

4. To choose a non-ratioed measurement, press:

MEAS **INPUT PORTS** **B** **TEST PORT 1**

This sets the source at PORT 1, and the measurement receiver to PORT 2, or B channel.

5. Set any other measurement parameters that you want for the device measurement: power, number of points, IF bandwidth.
6. To perform a receiver error-correction, press:

CAL **RECEIVER CAL** **0** **x1** **TAKE RCVR CAL SWEEP**

Note You can save or store the measurement correction to use for later measurements. Refer to the “Printing, Plotting, and Saving Measurement Results” chapter for procedures.

7. This completes the receiver calibration for transmission measurements. You can connect and measure your device under test.

Note The accuracy of the receiver calibration will be nearly the same as the test port power accuracy; and the test port power accuracy can be significantly improved by performing a power meter source calibration, as described later in this chapter

Frequency Response and Isolation Error-Corrections

- removes frequency response of the test setup
- removes isolation in transmission measurements
- removes directivity in reflection measurements

You can make a response and isolation correction for the following measurements.

- reflection measurements
- transmission measurements
- combined reflection and transmission measurements

Response and Isolation Error-Correction for Reflection Measurements

Although you can perform a response and isolation correction for reflection measurements, Hewlett-Packard recommends that you perform an S_{11} one-port error-correction; it is more accurate and just as convenient.

1. Press **PRESET**.
2. Select the type of measurement you want to make.
 - If you want to make a reflection measurement on PORT 1 (in the forward direction, S_{11}), leave the instrument default setting.
 - If you want to make a reflection measurement on PORT 2 (in the reverse direction, S_{22}), press:
MEAS Ref1: REV S22 (B/R)
3. Set any other measurement parameters that you want for the device measurement: power, sweep type, number of points, IF bandwidth.
4. To access the measurement correction menus, press:
CAL
5. If your calibration kit is different than the kit specified under the **CAL KIT []** softkey, press:
CAL KIT **SELECT CAL KIT** (select your type of kit) **RETURN**
If your type of calibration kit is not listed in the displayed menu, refer to the “Modifying Calibration Kit Standards” procedure, located later in this chapter.
6. To select a response and isolation correction, press:
CALIBRATE MENU **RESPONSE & ISOL'N** **RESPONSE**
7. Connect the short or open calibration standard to the port you selected for the test port (PORT 1 for S_{11} or PORT 2 for S_{22}).

Note Include any adapters that you will have in the device measurement. That is, connect the standard device to the particular connector where you will connect your device under test.

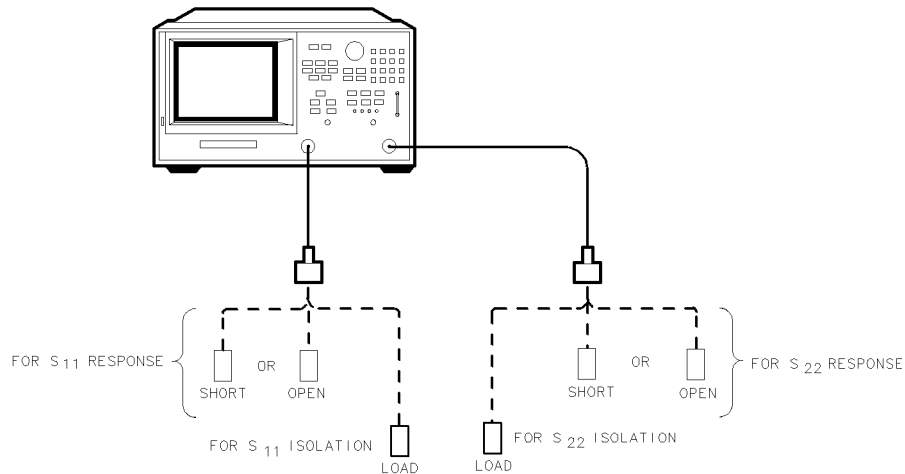

pg664d

Figure 5-4.
Standard Connections for a Response and Isolation Error-Correction for Reflection Measurements

8. To measure the standard, press:

SHORT or **OPEN**

If the calibration kit you selected has a choice between male and female calibration standards, remember to select the sex that applies to the test port and not the standard.

The analyzer displays WAIT - MEASURING CAL STANDARD during the standard measurement. The analyzer underlines the softkey that you selected after it finishes the measurement, and computes the error coefficients.

9. Connect the load calibration standard to the test port.
10. To measure the standard for the isolation portion of the correction, press:

ISOL'N STD

11. To compute the response and directivity error coefficients, press:

DONE RESP ISOL'N CAL

The analyzer displays the corrected S_{11} (or S_{22}) data. The analyzer also shows the notation Cor to the left of the screen, indicating that the correction is switched on for this channel.

Note You can save or store the error-correction to use for later measurements. Refer to the “Printing, Plotting, and Saving Measurement Results” chapter for procedures.

12. This completes the response and isolation error-correction for reflection measurements. You can connect and measure your device under test.

Response and Isolation Error-Correction for Transmission Measurements

This procedure is intended for measurements that have a measurement range of greater than 90 dB.

1. Press **PRESET**.
2. Select the type of measurement you want to make.
 - If you want to make a transmission measurement in the forward direction (S_{21}), press:
MEAS Trans: FWD S21 (B/R)
 - If you want to make a transmission measurement in the reverse direction (S_{12}), press:
MEAS Trans: REV S12 (A/R)
3. Set any other measurement parameters that you want for the device measurement: power, number of points, IF bandwidth.
4. To access the measurement correction menus, press:
CAL
5. If your calibration kit is different than the kit specified under the **CAL KIT []** softkey, press:
CAL KIT SELECT CAL KIT (select your type of kit)
If your type of calibration kit is not listed in the displayed menu, refer to the “Modifying Calibration Kit Standards” procedure, located later in this chapter.
6. To select a response and isolation correction, press:
CALIBRATE MENU RESPONSE & ISOL'N RESPONSE
7. Make a “thru” connection between the points where you will connect your device under test.

Note Include any adapters that you will have in the device measurement. That is, connect the standard device to the particular connector where you will connect your device under test.

8. To measure the standard, when the displayed trace has settled, press:
THRU
The analyzer displays **WAIT - MEASURING CAL STANDARD** during the standard measurement. The analyzer underlines the **THRU** softkey after it measures the calibration standard, and computes the error coefficients.
9. Connect impedance-matched loads to PORT 1 and PORT 2, as shown in Figure 5-5. Include the adapters that you would include for your device measurement.

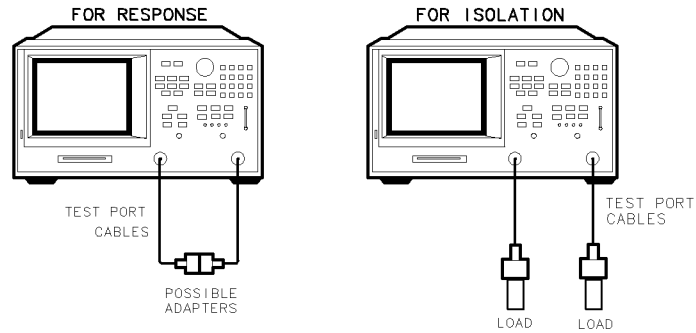

pg689d

Figure 5-5.
Standard Connections for a Response and Isolation Error-Correction for Transmission Measurements

Note If you will be measuring highly reflective devices, such as filters, use the test device, connected to the reference plane and terminated with a load, for the isolation standard.

10. To help remove crosstalk noise, set the analyzer as follows:
 - a. Press **[AVG]** **AVERAGING ON** **AVERAGING FACTOR** and enter at least four times more averages than desired during the device measurement.
 - b. Press **[CAL]** **MORE** **ALTERNATE A** and **B** to eliminate one crosstalk path.

11. To measure the calibration standard, press:

[CAL] **RESUME CAL SEQUENCE** **ISOL'N STD**

12. Return the averaging to the original state of the measurement. For example, reduce the averaging factor by at least four times or turn averaging off.

13. To compute the isolation error coefficients, press:

[CAL] **RESUME CAL SEQUENCE** **DONE RESP ISOL'N CAL**

The analyzer displays the corrected data trace. The analyzer also shows the notation **Cor** at the left of the screen, indicating that the correction is switched on for this channel.

Note You can save or store the measurement correction to use for later measurements. Refer to the “Printing, Plotting, and Saving Measurement Results” chapter for procedures.

14. This completes the response and isolation correction for transmission measurements. You can connect and measure your device under test.

One-Port Reflection Error-Correction

- removes directivity errors of the test setup
- removes source match errors of the test setup
- removes frequency response of the test setup

You can perform a 1-port correction for either an S_{11} or an S_{22} measurement. The only difference between the two procedures is the measurement parameter that you select.

Note This is the recommended error-correction process for all reflection measurements, when full two-port correction is not used.

1. Press **PRESET**.
2. Select the type of measurement you want to make.
 - If you want to make a reflection measurement on PORT 1 (in the forward direction, S_{11}), leave the instrument default setting.
 - If you want to make a reflection measurement on PORT 2 (in the reverse direction, S_{22}), press:
MEAS Ref1: REV S22 (B/R)
3. Set any other measurement parameters that you want for the device measurement: power, number of points, IF bandwidth.
4. To access the measurement correction menus, press:
CAL
5. If your calibration kit is different than the kit specified under the **CAL KIT []** softkey, press:
CAL KIT SELECT CAL KIT (select your type of kit) **RETURN**
If your type of calibration kit is not listed in the displayed menu, refer to the “Modifying Calibration Kit Standards” procedure, located later in this chapter.
6. To select the correction type, press:
CALIBRATE MENU and select the correction type
 - If you want to make a reflection measurement at PORT 1 press:
S11 1-PORT
 - If you want to make a reflection measurement at PORT 2, press:
S22 1-PORT
7. Connect a shielded open circuit to PORT 1 (or PORT 2 for an S_{22} measurement).

Note Include any adapters that you will have in the device measurement. That is, connect the calibration standard to the particular connector where you will connect your device under test.

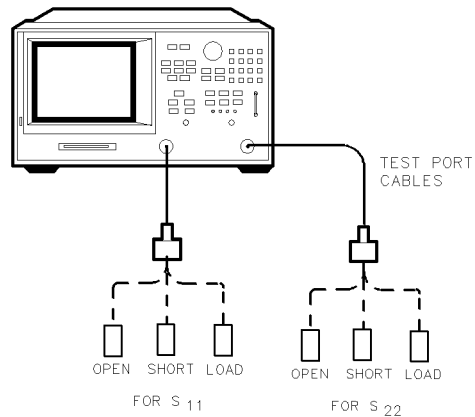

pg679d

Figure 5-6. Standard Connections for a One Port Reflection Error-Correction

8. To measure the standard, when the displayed trace has settled, press:

OPEN

Note If the calibration kit that you selected has a choice between male or female calibration standards, remember to select the sex that applies to the test port and not the standard.

The analyzer displays **WAIT - MEASURING CAL STANDARD** during the standard measurement. The analyzer underlines the **OPEN** softkey after it measures the calibration standard.

9. Disconnect the open, and connect a short circuit to the test port.
10. To measure the standard when the displayed trace has settled, press:

SHORT

The analyzer measures the short circuit and underlines the **SHORT** softkey.

11. Disconnect the short, and connect an impedance-matched load to the test port.
12. When the displayed trace settles, press **LOAD**.

The analyzer measures the load and underlines the **LOAD** softkey.

13. To compute the error coefficients, press:

DONE: 1-PORT CAL

The analyzer displays the corrected data trace. The analyzer also shows the notation **Cor** to the left of the screen, indicating that the correction is switched on for this channel.

Note The open, short, and load could be measured in any order, and need not follow the order in this example.

Note You can save or store the error-correction to use for later measurements. Refer to the “Printing, Plotting, and Saving Measurement Results” chapter for procedures.

14. This completes the one-port correction for reflection measurements. You can connect and measure your device under test.

Full Two-Port Error-Correction

- removes directivity errors of the test setup in forward and reverse directions
- removes source match errors of the test setup in forward and reverse directions
- removes load match errors of the test setup in forward and reverse directions
- removes isolation errors of the test setup in forward and reverse directions (optional)
- removes frequency response of the test setup in forward and reverse directions

Note This is the most accurate error-correction procedure. Since the analyzer takes both forward and reverse sweeps, this procedure takes more time than the other correction procedures.

1. Set any measurement parameters that you want for the device measurement: power, format, number of points, IF bandwidth.
2. To access the measurement correction menus, press:

CAL

3. If your calibration kit is different than the kit specified under the **CAL KIT []** softkey, press:

CAL KIT SELECT CAL KIT (select your type of kit) **RETURN**

If your type of calibration kit is not listed in the displayed menu, refer to the “Modifying Calibration Kit Standards” procedure, located later in this chapter.

4. To select the correction type, press:

CALIBRATE MENU FULL 2-PORT REFLECTION

5. Connect a shielded open circuit to PORT 1.

Note Include any adapters that you will have in the device measurement. That is, connect the standard to the particular connector where you will connect your device under test.

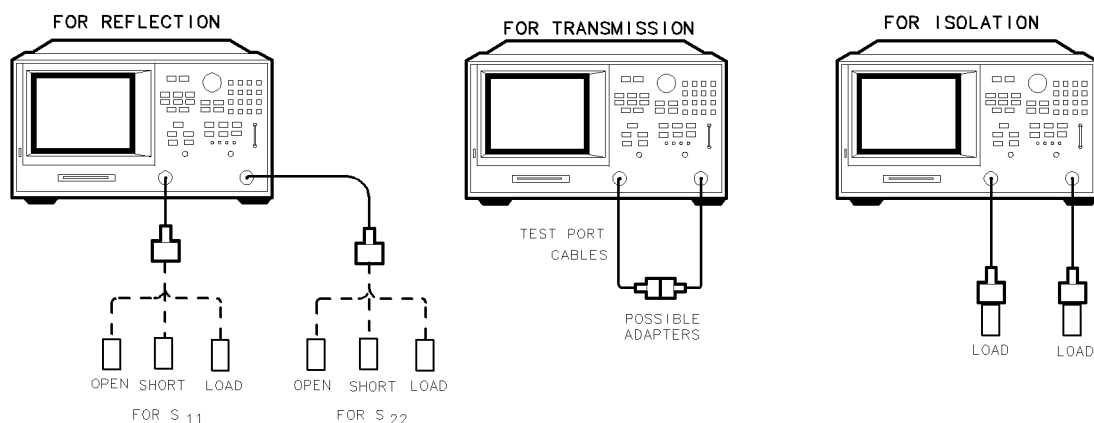

pg676d

Figure 5-7. Standard Connections for Full Two port Error-Correction

6. To measure the standard, when the displayed trace has settled, press:

FORWARD: OPEN

The analyzer displays **WAIT - MEASURING CAL STANDARD** during the standard measurement. The analyzer underlines the **OPEN** softkey after it measures the standard.

7. Disconnect the open, and connect a short circuit to PORT 1.
8. To measure the device, when the displayed trace has settled, press:

FORWARD: SHORT

The analyzer measures the short circuit and underlines the **SHORT** softkey.

9. Disconnect the short, and connect an impedance-matched load to PORT 1.
10. To measure the standard, when the displayed trace has settled, press:

FORWARD: LOAD

The analyzer measures the load and underlines the **LOAD** softkey.

11. Repeat the open-short-load measurements described above, but connect the devices in turn to PORT 2, and use the **REVERSE: OPEN**, **REVERSE: SHORT**, and **REVERSE: LOAD** softkeys. Include any adapters that you would include in your device measurement.

12. To compute the reflection correction coefficients, press:

STANDARDS DONE

13. To start the transmission portion of the correction, press: **TRANSMISSION**

14. Make a “thru” connection between the points where you will connect your device under test as shown in Figure 5-7.

Note Include any adapters or cables that you will have in the device measurement. That is, connect the standard device where you will connect your device under test.

Note The thru in most calibration kits is defined with zero length. The correction will *not* work properly if a non-zero length thru is used, unless the calibration kit is modified to change the defined thru to the length used. This is important for measurements of noninsertable devices (devices having ports that are both male or both female). The modified calibration kit must be saved as the user calibration kit, and the `USER KIT` must be selected before the calibration is started.

15. To measure the standard, when the trace has settled, press:

`DO BOTH FWD+REV`

The analyzer underlines the softkey label after it makes each measurement.

16. Press `ISOLATION` and select from the following two options:

If you will be measuring devices with a dynamic range less than 90 dB, press:

`OMIT ISOLATION`

If you will be measuring devices with a dynamic range greater than 90 dB, follow these steps:

a. Connect impedance-matched loads to PORT 1 and PORT 2. Include the adapters that you would include for your device measurement.

Note If you will be measuring highly reflective devices, such as filters, use the test device, connected to the reference plane and terminated with a load, for the isolation standard.

b. Activate at least four times more averages than desired during the device measurement.

Note If loads can be connected to both port 1 and port 2 simultaneously, then the following step can be performed using the `DO BOTH FWD + REV` softkey.

c. Press `(CAL) RESUME CAL SEQUENCE ISOLATION FWD ISOL'N ISOL'N STD
REV ISOL'N ISOL'N STD ISOLATION DONE`.

d. Return the averaging to the original state of the measurement, and press `(CAL)
RESUME CAL SEQUENCE`.

17. To compute the error coefficients, press:

`DONE 2-PORT CAL`

The analyzer displays the corrected measurement trace. The analyzer also shows the notation `Cor` at the left of the screen, indicating that error correction is on.

Note You can save or store the measurement correction to use for later measurements. Refer to the “Printing, Plotting, and Saving Measurement Results” chapter for procedures.

18. This completes the full two-port correction procedure. You can connect and measure your device under test.

TRL* and TRM* Error-Correction

The HP 8753D analyzer has the capability of making calibrations using the TRL*/LRM* method.

TRL Error-Correction

1. You must have a TRL calibration kit defined and saved in the `USER KIT`, as shown in “Modifying Calibration Kit Standards,” located later in this section.
2. Press `(CAL) CAL KIT SELECT CAL KIT USER KIT RETURN RETURN CALIBRATE MENU TRL*/LRM* 2-PORT`.
3. To measure the “TRL THRU,” connect the “zero length” transmission line between the two test ports.
4. To make the necessary four measurements, press:
`THRU TRLTHRU`
5. To measure the “TRL SHORT,” connect the short to PORT 1, and press:
`S11 REFL: TRLSHORT`
6. Connect the short to PORT 2, and press:
`S22 REFL: TRLSHORT`
7. To measure the “TRL LINE,” disconnect the short and connect the TRL line from PORT 1 to PORT 2.
8. Press `LINE/MATCH DO BOTH FWD+REV`.
9. The line data is measured and the `LN/MATCH1 TRLLINE` and `LN/MATCH2 TRLLINE` softkey labels are underlined.
10. To measure the “ISOLATION” class, press:
`ISOLATION`
 - You could choose not to perform the isolation measurement by pressing `OMIT ISOLATION DONE TRL/LRM`.

Note You should perform the isolation measurement when the highest dynamic range is desired.

To perform the best isolation measurements, you should reduce the system bandwidth, and/or activate the averaging function.

A poorly measured isolation class can actually degrade the overall measurement performance. If you are in doubt of the isolation measurement quality, you should omit the isolation portion of this procedure.

Note If loads can be connected to both port 1 and port 2 simultaneously, then the following measurement can be performed using the `DO BOTH FWD + REV` softkey.

11. Connect a load to PORT 2, and press:

REV ISOL'N ISOL'N STD

12. Connect the load to PORT 1, and press:

FWD ISOL'N ISOL'N STD

ISOLATION DONE

13. You may repeat any of the steps above. There is no requirement to go in the order of steps. When the analyzer detects that you have made all the necessary measurements, the message line will show PRESS 'DONE' IF FINISHED WITH CAL. Press DONE TRL/LRM.

The message COMPUTING CAL COEFFICIENTS will appear, indicating that the analyzer is performing the numerical calculations of error coefficients.

Note You can save or store the measurement correction to use for later measurements. Refer to the “Printing, Plotting, and Saving Measurement Results” chapter for procedures.

14. Connect the device under test. The device S-parameters are now being measured.

TRM Error-Correction

1. You must have a TRM calibration kit defined and saved in the USER KIT, as shown in “Modifying Calibration Kit Standards,” located later in this section.

Note This must be done before performing the following sequence.

2. Press **CAL** CAL KIT SELECT CAL KIT USER KIT RETURN RETURN CALIBRATE MENU TRL*/LRM* 2-PORT.

3. To measure the “TRM THRU,” connect the “zero length” transmission line between the two test ports.

4. To make the necessary four measurements, press:

THRU TRMTHRU

5. To measure the “TRM SHORT,” connect the short to PORT 1, and press:

S11 REFL: TRMSHORT

6. Connect the short to PORT 2, and press:

S22 REFL: TRMSHORT

Note If loads can be connected to both port 1 and port 2 simultaneously, then the following TRM load measurement can be performed using the DO BOTH FWD + REV softkey.

7. To measure the “TRM LOAD,” disconnect the short and connect the TRM load to PORT1. Refer to “Choosing Calibration Load Standards.”

8. Press `LINE/MATCH LN/MATCH1 TRMLoad` to access the Loads menu. When the displayed trace settles, press the softkey corresponding to the load used. If a sliding load is used, press `SLIDING` to access the Sliding Load menu. Position the slide and press `SLIDE IS SET`.
9. When all the appropriate load measurements are complete, the load data is measured and the `LN/MATCH1 TRMLoad` softkey label is underlined.
10. Connect the load to PORT 2 and press `LN/MATCH2 TRMLoad`.
11. Repeat the previous TRM load measurement steps for PORT 2.
12. After the measurement is complete, press:
`DONE LINE/MATCH`
13. To measure the “ISOLATION” class, press:
`ISOLATION`
 - You could choose not to perform the isolation measurement by pressing `OMIT ISOLATION DONE TRL/LRM`.

Note You should perform the isolation measurement when the highest dynamic range is desired.

To perform the best isolation measurements, you should reduce the system bandwidth, and/or activate the averaging function.

A poorly measured isolation class can actually degrade the overall measurement performance. If you are in doubt of the isolation measurement quality, you should omit the isolation portion of this procedure.

14. You may repeat any of the steps above. There is no requirement to go in the order of steps. When the analyzer detects that you have made all the necessary measurements, the message line will show `PRESS 'DONE' IF FINISHED WITH CAL`. Press `DONE TRL/LRM`.

The message `COMPUTING CAL COEFFICIENTS` will appear, indicating that the analyzer is performing the numerical calculations of error coefficients.

Note You can save or store the measurement correction to use for later measurements. Refer to the “Printing, Plotting, and Saving Measurement Results” chapter for procedures.

15. Connect the device under test. The device S-parameters are now being measured.

Note When making measurements using the same port with uncoupled channels, the power level for each channel must fall within the same power range setting of that single port. An error message will be displayed if you enter two power levels that do not fall within the same power range.

Modifying Calibration Kit Standards

Note Numerical data for most Hewlett-Packard calibration kits is provided in the calibration kit manuals.

The following section provides a summary of the information in the 8510-5A application note, as well as HP 8753D menu-specific information. For a detailed description of the menus and softkeys located in this section, as well as information about when user-defined calibration kits should be used, refer to Chapter 6, “Application and Operation Concepts.”

Definitions

The following are definitions of terms:

- A “standard” (represented by a number 1-8) is a specific, well-defined, physical device used to determine systematic errors. For example, standard 1 is a short in the 3.5 mm calibration kit.
- A standard “type” is one of five basic types that define the form or structure of the model to be used with that standard (short, open, load, delay/thru, and arbitrary impedance); standard 1 is of the type short in the 3.5 mm calibration kit.
- Standard “coefficients” are numerical characteristics of the standards used in the model selected. For example, the offset delay of the short is 32 ps in the 3.5 mm calibration kit.
- A standard “class” is a grouping of one or more standards that determines which of the eight standards are used at each step of the calibration. For example, standard number 2 makes up the S_{11A} reflection class.

Outline of Standard Modification

The following steps are used to modify or define user kit standard models, contained in the analyzer memory. It is not possible to alter the built-in calibration kits; all modifications will be saved in the user kit.

1. To modify a cal kit, first select the predefined kit to be modified. This is not necessary for defining a new cal kit.
2. Define the standards. For each standard, define which “type” of standard it is and its electrical characteristics.
3. Specify the class where the standard is to be assigned.
4. Store the modified cal kit.

Modifying Standards

1. Press **(CAL)** **CAL KIT** **SELECT CAL KIT**.
2. Select the softkey that corresponds to the kit you want to modify.
3. Press **RETURN** **MODIFY** **DEFINE STANDARD**.
4. Enter the number of the standard that you want to modify, followed by **(x1)**. Refer to your calibration kit manual for the numbers of the specific standards in your kit. For example, to select a short press **(1)** **(x1)**.

Table 5-3. Typical Calibration Kit Standard and Corresponding Number

Typical Standard Type	Default Standard Number
short (m)	1
open (m)	2
broadband load	3
delay/thru	4
sliding load	5
lowband load	6
short (f)	7
open (f)	8

5. Press the underlined softkey. For example, if you selected 1 (x1) in the previous step, SHORT should be the underlined softkey.

Note *Do not* press a softkey that is not underlined unless you want to change the “type” of standard.

6. This step applies only to the *open*. Go to the next step if you selected any other standard.
- Press OPEN CO. Observe the value on the analyzer screen. Use the entry keys on the analyzer front panel to change the value.
 - Repeat the modification for C1, C2, and C3.
7. This step applies only to the *load*. Go to the next step if you selected any other standard.
- Ensure that the correct load type is underlined: FIXED, SLIDING, or OFFSET.
8. Press SPECIFY OFFSET OFFSET DELAY and observe the value on the analyzer screen. To change the value, use the entry keys on the front panel.
9. Repeat the value modification for the characteristics listed below:
- OFFSET LOSS
 - OFFSET ZO
 - MINIMUM FREQUENCY
 - MAXIMUM FREQUENCY
10. Ensure that the correct transmission line is underlined: COAX or WAVEGUIDE.
11. Press STD OFFSET DONE STD DONE (DEFINED).
12. Repeat steps 4 through 11 for the remaining standards.

Saving the modified calibration constants

If you made modifications to any of the standard definitions, follow the remaining steps in this procedure to assign a kit label, and store them in the non-volatile memory. The new set of standard definitions will be available under **USER KIT** until you save another user kit.

13. Press **(CAL) CAL KIT MODIFY LABEL KIT ERASE TITLE**. Use the front panel knob to move the pointer to a character and press **SELECT LETTER**.

Note To enter titles, you may also use the optional external keyboard.

14. Press **DONE KIT DONE (MODIFIED) SAVE USER KIT**.

Note You may also save the user kit to disk, by selecting the particular kit at the time you save a measurement result.

Modifying TRL Standards

In order to use the TRL technique, the calibration standards characteristics must be entered into the analyzer's user defined calibration kit.

This example procedure shows you how to define a calibration kit to utilize a set of TRL (THRU, REFLECT, LINE) standards. This example TRL kit contains the following:

- zero length THRU
- "flush" short for the REFLECT standard (0 second offset)
- 50 ohm transmission line with 80 ps of offset delay for the LINE

Note Hewlett-Packard strongly recommends that you read product note 8510-8A before you attempt to modify the standard definitions. The part number of this product note is 5091-3645E. Although the product note was written for the HP 8510 family of network analyzers, it also applies to the HP 8753D.

For a discussion on TRL calibration, refer to "TRL/LRM Calibration" in Chapter 6, "Application and Operation Concepts."

Modify the Standard Definitions

1. Press the following keys to start modifying the standard definitions:

(PRESET)
(CAL) CAL KIT MODIFY DEFINE STANDARD

2. To select a short, press **(1) (x1)**. (In this example the REFLECT standard is a SHORT.)
3. Press the following keys:

SHORT SPECIFY OFFSET OFFSET DELAY
(0) (x1) STD OFFSET DONE STD DONE (DEFINED)

4. To define the THRU/LINE standard, press:

```
DEFINE STANDARD 4 x1
DELAY/THRU SPECIFY OFFSET OFFSET DELAY 0 x1
STD OFFSET DONE STD DONE (DEFINED)
```

5. To define the LINE/MATCH standard, press:

```
DEFINE STANDARD 6 x1
DELAY/THRU SPECIFY OFFSET OFFSET DELAY .08 G/n
STD OFFSET DONE
```

6. For the purposes of this example, change the name of the standard by pressing LABEL STD and modifying the name to "LINE."
7. When the title area shows the new label, press:

```
DONE STD DONE (DEFINED)
```

Assign the Standards to the Various TRL Classes

8. To assign the calibration standards to the various TRL calibration classes, press:

```
SPECIFY CLASS MORE MORE TRL REFLECT
```

9. Since you previously designated standard #1 for the REFLECT standard, press:

```
1 x1
```

10. Since you previously designated standard #6 for the LINE/MATCH standard, press:

```
TRL LINE OR MATCH 6 x1
```

11. Since you previously designated standard #4 for the THRU/LINE standard, press:

```
TRL THRU 4 x1
```

12. To complete the specification of class assignments, press:

```
SPECIFY CLASS DONE
```

Label the Classes

Note To enter the following label titles, an external keyboard may be used for convenience.

13. Press LABELCLASS MORE MORE .
14. Change the label of the “TRL REFLECT” class to “TRLSHORT.”
15. Change the label of the “TRL LINE OR MATCH” class to “TRLLINE.”
16. Change the label of the “TRL THRU” class to “TRLTHRU.”
17. Press LABEL CLASS DONE .

Label the Calibration Kit

18. Press LABELKIT and create a label up to 8 characters long. For this example, enter “TRL KIT1” DONE .
19. To save the newly defined kit into nonvolatile memory, press:

KIT DONE (MODIFIED) SAVE USER KIT

Modifying TRM Standards

In order to use the TRL technique, the calibration standards characteristics must be entered into the analyzer’s user defined calibration kit.

This example procedure shows you how to define a calibration kit to utilize a set of TRM (THRU, REFLECT, MATCH) standards. This example TRM kit contains the following:

- zero length THRU
- “flush” short for the REFLECT standard (0 second offset)
- 50 ohm termination for the MATCH (infinite length line)

Note Hewlett-Packard strongly recommends that you read product note 8510-8A before you attempt to modify the standard definitions. The part number of this product note is 5091-3645E. Although the product note was written for the HP 8510 family of network analyzers, it also applies to the HP 8753D.

For a discussion on TRL calibration, refer to “TRL/LRM Calibration” in Chapter 6, “Application and Operation Concepts.”

Modify the Standard Definitions

1. Press the following keys to start modifying the standard definitions:

PRESET
CAL CAL KIT MODIFY DEFINE STANDARD

2. To select a short, press 1 (x1). (In this example the REFLECT standard is a SHORT.)
3. Press the following keys:

SHORT SPECIFY OFFSET OFFSET DELAY
0 (x1) STD OFFSET DONE STD DONE (DEFINED)

4. To define the THRU/LINE standard, press:

DEFINE STANDARD (4) (x1)
DELAY/THRU SPECIFY OFFSET OFFSET DELAY (0) (x1)
STD OFFSET DONE STD DONE (DEFINED)

5. To define the LINE/MATCH standard, press:

DEFINE STANDARD (3) (x1)
LOAD

6. For the purposes of this example, change the name of the standard by pressing LABEL STD ERASE TITLE , if a previous title exists, and then modify the name to "MATCH".

7. When the title area shows the new label, press:

DONE STD DONE (DEFINED)

Assign the Standards to the Various TRM Classes

8. To assign the calibration standards to the various TRL calibration classes, press:

SPECIFY CLASS MORE MORE TRL REFLECT

9. Since you previously designated standard #1 for the REFLECT standard, press:

(1) (x1)

10. Since you previously designated standard #3 for the LINE/MATCH standard, press:

TRL LINE OR MATCH (3) (x1)

11. Since you previously designated standard #4 for the THRU/LINE standard, press:

TRL THRU (4) (x1)

12. To complete the specification of class assignments, press:

SPECIFY CLASS DONE

Label the Classes

Note To enter the following label titles, an external keyboard may be used for convenience.

13. Press LABELCLASS MORE MORE .
14. Change the label of the “TRL REFLECT” class to “TRMSHORT.”
15. Change the label of the “TRL LINE OR MATCH” class to “TRMLOAD.”
16. Change the label of the “TRL THRU” class to “TRMTHRU.”
17. Press LABEL CLASS DONE .

Label the Calibration Kit

18. Press LABELKIT and create a label up to 8 characters long. For this example, enter “TRM
KIT1”. DONE
19. To save the newly defined kit into nonvolatile memory, press:
KIT DONE (MODIFIED) SAVE USER KIT

Power Meter Measurement Calibration

You can use the power meter to monitor and correct the analyzer source power to achieve calibrated absolute power at the test port. You can also use this calibration to set a reference power for receiver power calibration, and mixer measurement calibration. The power meter can measure and correct power in two ways:

- continuous correction — each sweep mode
- sample-and-sweep correction — single sweep mode

The time required to perform a power meter calibration depends on the source power, number of points tested, and number of readings taken. The parameters used to derive the characteristic values in Table 5-4 are as follows:

- number of points: 51, 100 kHz to 3 GHz
- test port power: equal to calibration power

Table 5-4.
Characteristic Power Meter Calibration Sweep Speed and Accuracy

Power Desired at Test Port (dBm)	Number of Readings	Sweep Time (seconds) ¹	Characteristic Accuracy (dB) ²
+5	1	33	±0.7
	2	64	±0.2
	3	95	±0.1
-15	1	48	±0.7
	2	92	±0.2
	3	123	±0.1
-30	1	194	±0.7
	2	360	±0.2
	3	447	±0.1

¹ Sweep speed applies to every sweep in continuous correction mode, and to the first sweep in sample-and-sweep mode. Subsequent sweeps in sample-and-sweep mode will be much faster.

² The accuracy values were derived by combining the accuracy of the power meter and linearity of the analyzer's internal source, as well as the mismatch uncertainty associated with the power sensor.

Note Loss of Power Calibration Data

If your instrument state has not been saved after a power meter calibration, the power correction data will be lost if any of the following circumstances exists:

- if you switch off the analyzer ac power and you haven't saved the correction in an internal register
 - if you press **[PRESET]** and you haven't saved the correction in an internal register
 - if you change the sweep type (linear, log, list, CW, power) when the power meter correction is activated
 - if you change the frequency when the sweep type is in log or list mode
-

Entering the Power Sensor Calibration Data

Entering the power sensor calibration data compensates for the frequency response of the power sensor, thus ensuring the accuracy of power meter calibration.

1. Make sure that your analyzer and power meter are configured. Refer to the “Compatible Peripherals” chapter for configuration procedures.
2. Press **CAL** **PWRMTR CAL** **LOSS/SENSR LISTS** **CAL FACTOR SENSOR A**.
The analyzer shows the notation **EMPTY**, if you have not entered any segment information.

3. To create the first segment, press:

ADD FREQUENCY

4. Enter the frequency of a correction factor data point, as listed on the power sensor, followed by the appropriate key: **(G/n)** **(M/μ)** **(k/m)**.
5. Press **CAL FACTOR** and enter the correction factor that corresponds to the frequency that you have entered in the previous step. Complete the correction factor entry by pressing **(x1)** **DONE**.
6. Repeat the previous two steps to enter up to 55 frequency segments.

You may enter multiple segments in any order because the analyzer automatically sorts them and lists them on the display by frequency value. The analyzer also automatically interpolates the values between correction factor data points.

If you only enter one frequency segment the analyzer assumes that the single value is valid over the entire frequency range of the correction.

7. After you have entered all the frequency segments, press **DONE**.

Editing Frequency Segments

1. Access the “Segment Modify Menu” by pressing **CAL** **PWRMTR CAL** **LOSS/SENSR LISTS** **CAL FACTOR SENSOR A** (or **CAL FACTOR SENSOR B**, depending on where the segment is that you want to edit).
2. Identify the segment that you want to edit by pressing **SEGMENT** and using the **(↑)** and **(↓)** keys to locate and position the segment next to the pointer (**>**), shown on the display. Or press **SEGMENT** and enter the segment number followed by **(x1)**.
3. Press **EDIT** and then press either the **FREQUENCY** or **CAL FACTOR** key, depending of which part of the segment you want to edit.
 - If you are modifying the frequency, enter the new value, followed by a **(G/n)**, **(M/μ)**, or **(k/m)** key.
 - If you are modifying the correction factor, enter the new value, followed by the **(x1)** key.
4. Press **DONE** after you have finished modifying the segment.
5. If you want to edit any other segments, press **SEGMENT** and follow the previous steps, starting with step 2.

Deleting Frequency Segments

1. Access the “Segment Modify Menu” by pressing **CAL** **PWRMTR CAL** **LOSS/SENSR LISTS** **CAL FACTOR SENSOR A** (or **CAL FACTOR SENSOR B**, depending on where the segment is that you want to delete).
2. Identify the segment that you want to delete by pressing **SEGMENT** and using the **↑** and **↓** keys to locate and position the segment next to the pointer (>), shown on the display. Or press **SEGMENT** and enter the segment number followed by **x1**.
3. Press **DELETE**.
The analyzer deletes the segment and moves the remainder of the segments up one number.
4. You could also delete all the segments in a list by pressing **CLEAR LIST** **YES**.
5. Press **DONE** when you are finished modifying the segment list.

Compensating for Directional Coupler Response

If you use a directional coupler to sample power in your measurement configuration, you should enter the coupled arm power loss value into the power loss table, using the following procedure. You can enter the loss information in a single segment, and the analyzer will assume that the value applies to the entire frequency range of the instrument. Or, you can input actual measured power loss values at several frequencies using up to 55 segments, enhancing power accuracy.

1. Press **CAL** **PWRMTR CAL** **LOSS/SENSR LISTS** **POWER LOSS**.
The analyzer shows the notation **EMPTY**, if you have not entered any segment information.
2. To create the first segment, press **ADD FREQUENCY** and enter a frequency of a correction factor data point, followed by the appropriate key: **G/n** **M/μ** **k/m**.
3. Press **LOSS** and enter the power loss that corresponds to the attenuation of the directional coupler (or power splitter) at the frequency that you have entered in the previous step. Complete the power loss entry by pressing **x1** **DONE**.

Note Remember to subtract the through arm loss from the coupler arm loss before entering it into the power loss table, to ensure the correct power at the output of the coupler.

4. Repeat the previous two steps to enter up to 55 frequency segments, depending on the required accuracy.
You may enter multiple segments in any order because the analyzer automatically sorts them and lists them on the display in increasing order of frequency.
If you only enter one frequency segment, the analyzer assumes that the single value is valid over the entire frequency range of the correction.
5. After you have entered all the segments, press **DONE**.
6. Press **CAL** **PWRMTR CAL** **PWR LOSS ON** to activate the power loss compensation.

Using Sample-and-Sweep Correction Mode

You can use the sample-and-sweep mode to correct the analyzer output power and update the power meter correction data table, during the initial measurement sweep. Because the analyzer measures the actual power at each frequency point during the initial sweep, the initial sweep time is significant. However, in this mode of operation the analyzer does not require the power meter for subsequent sweeps. Therefore, this mode sweeps considerably faster than the continuous correction mode.

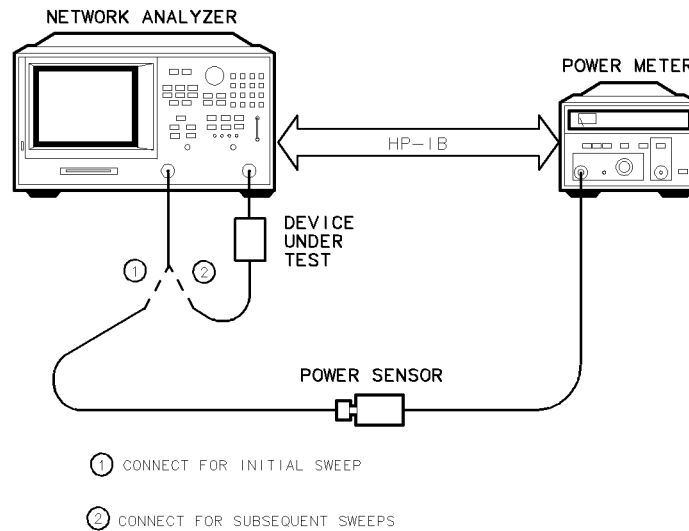

pg698d

Figure 5-8. Sample-and-Sweep Mode for Power Meter Calibration

1. Calibrate and zero the power meter.
2. Connect the equipment as shown in Figure 5-8.
3. Select the HP 8753D as the system controller:

```
LOCAL
SYSTEM CONTROLLER
```

4. Set the power meter's address:

```
SET ADDRESSES
ADDRESS: P MTR/HPIB ## x1
```

5. Select the appropriate power meter by pressing **POWER MTR []** until the correct model number is displayed (HP 436A or HP 438A/437).
6. Set test port power to the approximate desired corrected power.
7. Press **(CAL) PWRMTR CAL** and enter the test port power level that you want at the input to your test device. For example, if you enter **(-10) (x1)**, the display will read CAL POWER -10.
8. If you want the analyzer to make more than one power measurement at each frequency data point, press:

```
NUMBER OF READINGS (n) (x1), (where n = the number of desired iterations).
```

If you increase the number of readings, the power meter correction time will substantially increase.

9. Press **CAL** **PWRMTR CAL** **ONE SWEEP** **TAKE CAL SWEEP**.

Note Because power meter calibration requires a longer sweep time, you may want to reduce the number of points before pressing **TAKE CAL SWEEP**. After the power meter calibration is finished, return the number of points to its original value and the analyzer will automatically interpolate this calibration. Some accuracy will be lost for the interpolated points.

The analyzer will use the data table for subsequent sweeps to correct the output power level at each measurement point. Also, the status annunciator PC will appear on the analyzer display.

Note You can abort the calibration sweep by pressing **PWRMTR CAL OFF**.

10. Remove the power sensor from the analyzer test port and connect your test device.

Using Continuous Correction Mode

You can set the analyzer to update the correction table at each sweep (as in a leveling application), using the continuous sample mode. When the analyzer is in this mode, it continuously checks power at every point in each sweep. You must keep the power meter connected as shown in Figure 5-9. This mode is also known as power meter leveling, and the speed is limited by the power meter.

Note You may level at the input of a device under test, using a 2-resistor power splitter or a directional coupler before the device; or level at the output of the device using a 3-resistor power splitter or a bidirectional coupler after the device.

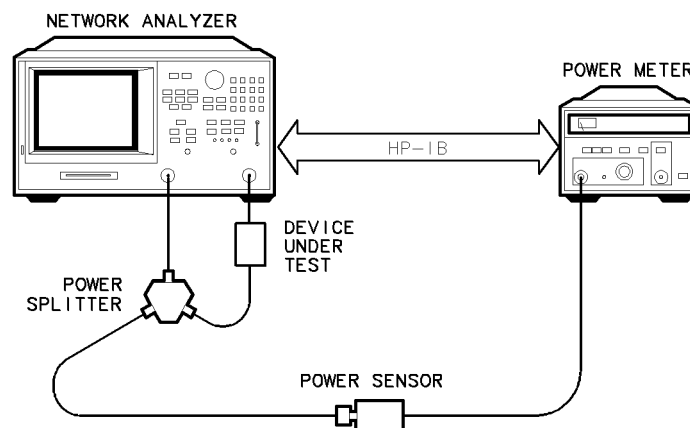

pg680d

Figure 5-9. Continuous Correction Mode for Power Meter Calibration

1. Connect a power splitter or directional coupler to the port supplying RF power to your test device, as shown in Figure 5-9.
2. Set test port power to approximate desired leveled power.

3. Press **CAL** **PWRMTR CAL** and enter the test port power level that you want the analyzer to maintain at the input to your test device. Compensate for the power loss of the power splitter or directional coupler in the setup.
4. If you want the analyzer to make more than one power measurement at each frequency data point, press **NUMBER OF READINGS** **(n)** **(x1)**, (where n = the number of desired iterations).

If you increase the number of readings, the power meter correction time will substantially increase.

5. Press **CAL** **PWRMTR CAL** **EACH SWEEP** **TAKE CAL SWEEP** to activate the power meter correction.

To Calibrate the Analyzer Receiver to Measure Absolute Power

You can use the power meter calibration as a reference to calibrate the analyzer receiver to accurately measure absolute power. The following procedure shows you how to calibrate the receiver to any power level.

1. Set the analyzer test port power to the desired level:

(MENU) **POWER** (enter power level) **(x1)**

2. Connect the power sensor to the analyzer test port 1.
3. To apply the one sweep mode, press:

CAL **PWRMTR CAL** (enter power level) **(x1)** **ONE SWEEP** **TAKE CAL SWEEP**

Note Because power meter calibration requires a longer sweep time, you may want to reduce the number of points before pressing **TAKE CAL SWEEP**. After the power meter calibration is finished, return the number of points to its original value and the analyzer will automatically interpolate this calibration.

The status notation PC will appear on the analyzer display. Port 1 is now a calibrated source of power.

4. Connect the test port 1 output to the test port 2 input.
5. Choose a non-ratioed measurement by pressing:

(MEAS) **INPUT PORTS** **B** **TEST PORT 1**

This sets the source at PORT 1, and the measurement receiver to PORT 2, or input port B.

6. To perform a receiver error-correction, press:

CAL **RECEIVER CAL** (enter power level) **(x1)** **TAKE RCVR CAL SWEEP**

The receiver channel now measures power to a characteristic accuracy of 0.35 dB or better. The accuracy depends on the match of the power meter, the source, and the receiver.

Matched Adapters

With this method, you use two precision matched adapters which are “equal.” To be equal, the adapters must have the same match, Z_0 , insertion loss, and electrical delay. The adapters in most HP calibration kits have matched electrical length, even if the physical lengths appear different.

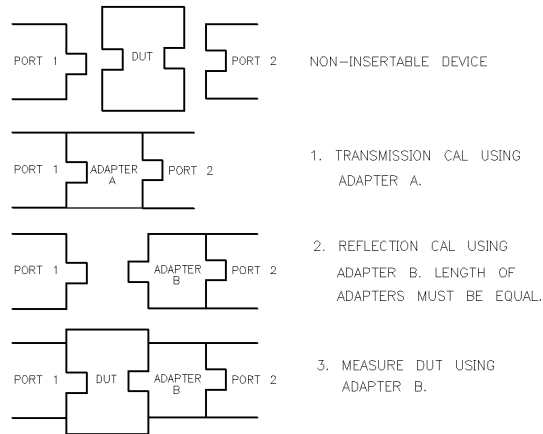

pg6136d

Figure 5-10. Calibrating for Noninsertable Devices

To use this method, refer to Figure 5-10 and perform the following steps:

1. Perform a transmission calibration using the first adapter.
2. Remove adapter A, and place adapter B on port 2. Adapter B becomes the effective test port.
3. Perform a reflection calibration.
4. Measure the test device with adapter B in place.

The errors remaining after calibration with this method are equal to the differences between the two adapters that are used.

Modify the Cal Kit Thru Definition

With this method it is only necessary to use adapter B. The calibration kit thru definition is modified to compensate for the adapter and then saved as a user kit. However, the electrical delay of the adapter must first be found.

1. Perform a 1-port calibration on PORT 2.
2. Connect adapter B to the test port.
3. Add a short to the open end of the B adapter.
4. Measure the delay of the adapter by pressing **FORMAT** **DELAY**.
5. Divide the resulting delay measurement by 2.
6. Determine the offset delay of the calibration short by examining the define standard menu (see “Define Standard Menus”).
7. Subtract the short offset delay from the value calculated in step 5. This corresponds to the delay of adapter B.
8. Modify the calibration kit thru definition by entering in the electrical delay of adapter B. Save this as a user kit.
9. Perform the desired calibration with this new user kit.
10. Measure the test device.

Calibrating for Noninsertable Devices

A test device having the same sex connector on both the input and output cannot be connected directly into a transmission test configuration. Therefore, the device is considered to be *noninsertable*, and one of the following calibration methods must be performed:

- adapter removal
- matched adapters
- modify the cal kit thru definition

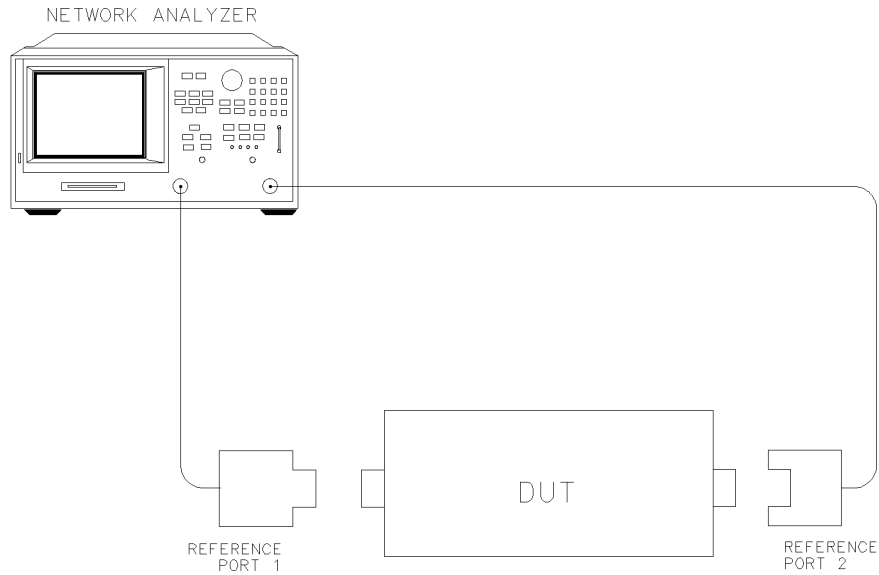

pg6281d

Figure 5-11. Noninsertable Device

Adapter Removal

The adapter removal technique provides a means to accurately measure noninsertable devices. The following adapters are needed:

- Adapter A1, which mates with port 1 of the device, must be installed on test set port 1.
- Adapter A2, which mates with port 2 of the device, must be installed on test set port 2.
- Adapter A3 must match the connectors on the test device. The effects of this adapter will be completely removed with this calibration technique.

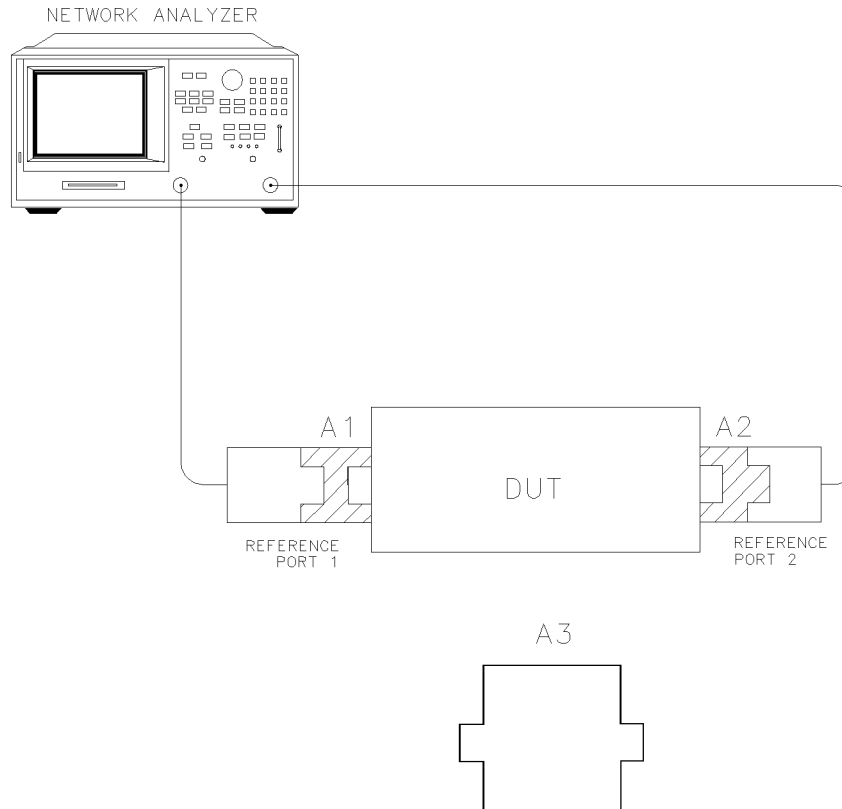

pg6282d

Figure 5-12. Adapters Needed

The following requirements must also be met:

- Calibration standards for performing a 2-port error correction for each connector type.
- Specified electrical length of adapter A3 within $\pm 1/4$ wavelength for the measurement frequency range.

For each port, a separate 2-port error correction needs to be performed to create two calibration sets. The adapter removal algorithm uses the resultant data from the two calibration sets and the nominal electrical length of the adapter to compute the adapter's actual S-parameters. This data is then used to generate a separate third calibration set in which the forward and reverse match and tracking terms are as if port 1 and port 2 could be connected. This is possible because the actual S-parameters of the adapter are measured with great accuracy, thus allowing the effects of the adapter to be completely removed when the third cal set is generated.

Perform the 2-port Error Corrections

1. Connect adapter A3 to adapter A2 on port 2. (See Figure 5-12)

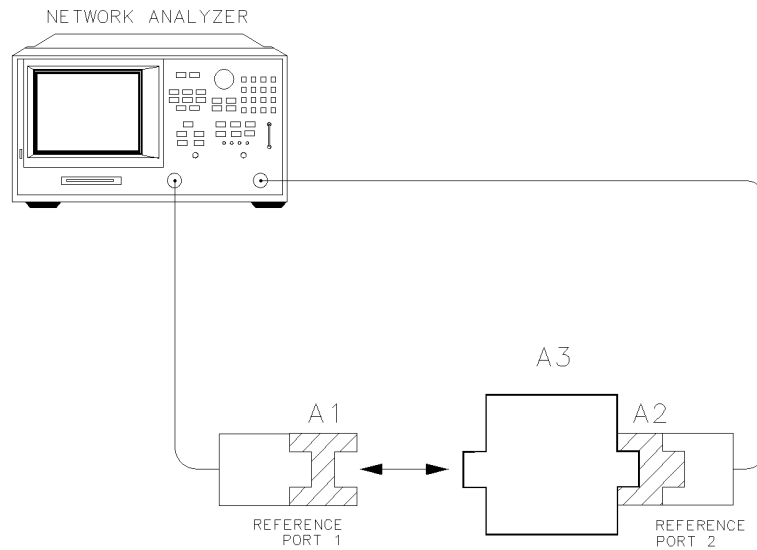

pg6283d

Figure 5-13. Two-Port Cal Set 1

2. Perform the 2-port error correction using calibration standards appropriate for the connector type at port 1.

Note When using adapter removal calibration, you must save calibration sets to the internal disk, not to internal memory.

3. Save the results to disk. Name the file "PORT1."
4. Connect adapter A3 to adapter A1 on port 1. (See Figure 5-13)

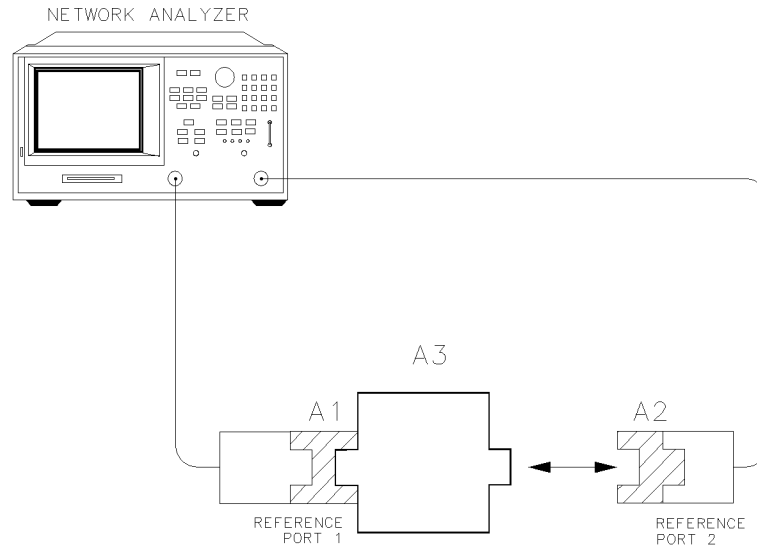

pg6284d

Figure 5-14. Two-Port Cal Set 2

5. Perform the 2-port error correction using calibration standards appropriate for the connector type at port 2.
6. Save the results to disk. Name the file "PORT2."
7. Determine the electrical delay of adapter A3 by performing steps 1 through 7 of "Modify the Cal Kit Thru Definition."

Remove the Adapter

When the two sets of error correction files have been created (now referred to as "cal sets"), the adapter may be removed.

8. Press **CAL** **MORE** **ADAPTER REMOVAL**. This brings up the following menu:
 - **HELP ADAPT REMOVAL** (This provides a quick reference guide to using the adapter removal technique.)
 - **RECALL CAL SETS**
 - **ADAPTER DELAY**
 - **ADAPTER COAX**
 - **ADAPTER WAVEGUIDE**
 - **REMOVE ADAPTER**
9. Press **RECALL CAL SETS** to bring up the following two choices:
 - **RECALL CAL PORT 1**
 - **RECALL CAL PORT 2**

RECALL CAL SETS also brings up the internal (or external if internal not used) disk file directory.

Note In the following two steps, calibration data is recalled, not instrument states.

10. From the disk directory, choose the file associated with the port 1 error correction, then press **RECALL CAL PORT 1**.
11. When this is complete, choose the file for the port 2 error correction and press **RECALL CAL PORT 2**.
12. When complete, press **RETURN**.
13. Enter the value of the electrical delay of adapter A3.
Press **ADAPTER DELAY** and enter the value.
14. Select the appropriate key: **ADAPTER COAX** or **ADAPTER WAVEGUIDE**.
15. Press **REMOVE ADAPTER** to complete the technique for calculating the new error coefficients and overwrite the current active calibration set in use.
16. To save the results of the new cal set, press **(SAVE/RECALL) SELECT DISK INTERNAL DISK** (or **EXTERNAL DISK**) **RETURN SAVE STATE**.

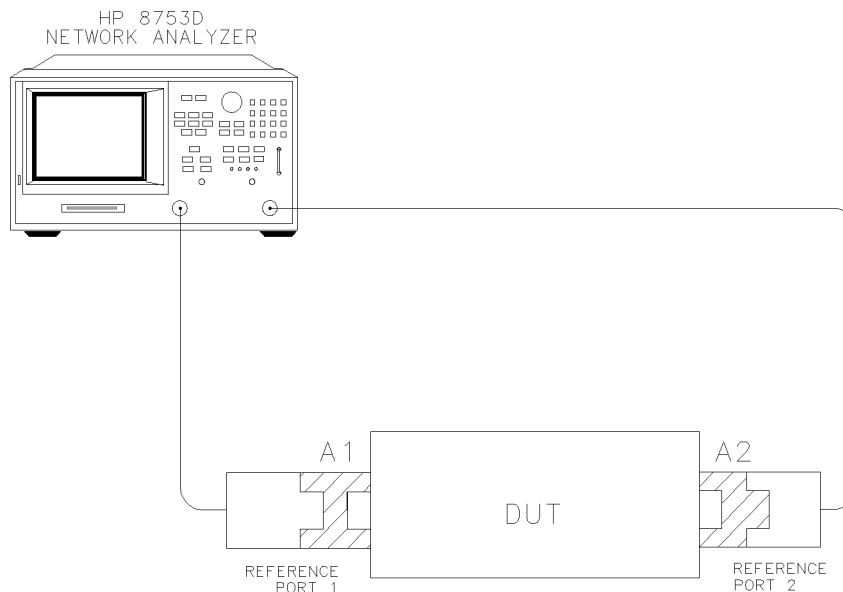

pg6285d

Figure 5-15. Calibrated Measurement

Verify the Results

Since the effect of the adapter has been removed, it is easy to verify the accuracy of the technique by simply measuring the adapter itself. Because the adapter was used during the creation of the two cal sets, and the technique removes its effects, measurement of the adapter itself should show the S-parameters.

If unexpected phase variations are observed, this indicates that the electrical delay of the adapter was not specified within a quarter wavelength over the frequency range of interest. To correct this, recall both cal sets, since the data was previously stored to disk, change the adapter delay, and press `REMOVE ADAPTER`.

Example Program

The following is an example program for performing these same operations over HP-IB:

```
10 ! File: adaptrm.bas
20 !
30 ! This demonstrates how to do adapter removal over HP--IB.
40 !
50 ASSIGN @Na TO 716
60 !
70 ! Select internal disk.
80 !
90 OUTPUT @Na;"INTD;"
100 !
110 ! Assign file #1 to the filename that has a 2-port
120 ! cal previously performed for Port 1's connector.
130 !
140 OUTPUT @Na;"TITF1""F10DCAL1"";"
150 !
160 ! Recall the cal set for Port 1.
170 !
180 OUTPUT @Na;"CALSPORT1;"
190 !
200 ! Assign file #2 to the filename that has a 2-port
210 ! cal previously performed for Port 2's connector.
220 !
230 OUTPUT @Na;"INTD;TITF2""F20DCAL2"";"
240 !
250 ! Recall the cal set for Port 2.
260 !
270 OUTPUT @Na;"CALSPORT2;"
280 !
290 ! Set the adapter electrical delay.
300 !
310 OUTPUT @Na;"ADAP158PS;"
320 !
330 ! Perform the "remove adapter" computation.
340 !
350 !OUTPUT @Na;"MODS;"
360 END
```

Making Accurate Measurements of Electrically Long Devices

A device with a long electrical delay, such as a long length of cable or a SAW filter, presents some unusual measurement problems to a network analyzer operating in swept frequency mode. Often the measured response is dependent on the analyzer's sweep time, and incorrect data may be obtained. At faster sweep rates, the magnitude of the response may seem to drop and look distorted, while at slower sweep rates it looks correct. The results may indicate that a cable has more loss than it truly does, or that a filter has some unusual ripple in the passband which isn't really there.

This section describes the cause of this behavior, and how to accurately measure these electrically long devices.

The Cause of Measurement Problems

When using a vector network analyzer to measure a device that has a long electrical delay (ΔT), the device's time delay causes a frequency shift between its input and output signals. The frequency shift, ΔF , equals the product of the sweep rate and the time delay:

$$\Delta F = dF/dt * \Delta T$$

Since frequency is changing with time as the analyzer sweeps, the time delay of the DUT causes a frequency offset between its input and output. In the analyzer receiver, the test and reference input signals will differ in frequency by ΔF . Because the test signal frequency is slightly different than the receiver frequency, the analyzer will err in measuring its magnitude or phase. The faster the analyzer's sweep rate, the larger ΔF becomes, and the larger the error in the test channel.

The HP 8753D network analyzers do not sweep at a constant rate. The frequency range is covered in several bands, and the sweep rate may be different in each band. So if an operator sets up a broadband sweep with the minimum sweep time, the error in measuring a long device will be different in each band, and the data will be discontinuous at each band edge. This can produce confusing results which make it difficult to determine the true response of the device.

To Improve Measurement Results

To reduce the error in these measurements, the frequency shift, ΔF , must be reduced. ΔF can be reduced by using the following three methods:

- decreasing the sweep rate
- decreasing the time delay (ΔT)

Decreasing the Sweep Rate

The sweep rate can be decreased by increasing the analyzer's sweep time. To increase the analyzer's sweep time, press **[MENU] SWEEP TIME [MANUAL]** and use the front panel knob, the step **[↑] [↓]** keys, or the front panel keypad enter in the appropriate sweep time.

Selection of the appropriate sweep time depends on the device being measured; the longer the electrical delay of the device under test, the slower the sweep rate must be. A good way to tell when the sweep rate is slow enough is to put the vector network analyzer into a list frequency mode of sweeping, and compare the data. In this mode, the vector network analyzer does not sweep the frequency, but steps to each listed frequency point, stops, makes a measurement, then goes on to the next point. Because errors do not occur in the list frequency mode, it can be used to check the data. The disadvantage of the list frequency mode is that it is slower than sweeping.

Decreasing the Time Delay

The other way to reduce ΔF is by decreasing the time delay, ΔT . Since ΔT is a property of the device that is being measured, it cannot literally be decreased. However, what can be decreased is the difference in delay times between the paths to the R channel and the B channel. These times can be equalized by adding a length of cable to the R channel which has approximately the same delay as the device under test.

This length of cable can be inserted between the R CHANNEL IN and OUT connectors on the front panel of the analyzer. The delay of this cable must be less than $5\mu\text{s}$.

Increasing Sweep Speed

You can increase the analyzer sweep speed by avoiding the use of some features that require computational time for implementation and updating, such as bandwidth marker tracking.

You can also increase the sweep speed by making adjustments to the measurement settings. The following suggestions for increasing sweep speed are general rules that you should experiment with:

- decrease the frequency span
- set the auto sweep time mode
- widen the system bandwidth
- reduce the averaging factor
- reduce the number of measurement points
- set the sweep type
- use chop sweep mode
- use external calibration
- fast 2-port calibration mode

To Decrease the Frequency Span

The hardware of the network analyzer sweeps the frequency range in separate bands, where switching from band to band takes time. Modify the frequency span to eliminate as many band switches as possible while maintaining measurement integrity. Refer to the following table to identify the analyzer's band switch points:

Table 5-5. Band Switch Points

Band	Frequency Span
0	.01 MHz to .3 MHz
1	.3 MHz to 3.3 MHz
2	3.3 MHz to 16 MHz
3	16 MHz to 31 MHz
4	31 MHz to 61 MHz
5	61 MHz to 121 MHz
6	121 MHz to 178 MHz
7	178 MHz to 296 MHz
8	296 MHz to 536 MHz
9	536 MHz to 893 MHz
10	893 MHz to 1.607 GHz
11	1.607 GHz to 3 GHz
12 (Option 006)	3 GHz to 4.95 GHz
13 (Option 006)	4.95 GHz to 6 GHz

To Set the Auto Sweep Time Mode

Auto sweep time mode is the default mode (the preset mode). This mode maintains the fastest sweep speed possible for the current measurement settings.

- Press **MENU** **SWEEP TIME** **0** **x1**, to re-enter the auto mode.

To Widen the System Bandwidth

1. Press **AVG** **IF BW**.
2. Set the IF bandwidth to change the sweep time.

The following table shows the relative increase in sweep time as you decrease system bandwidth. The characteristic values in the following table were derived using 201 measurement points.

IF BW	Cycle Time (Seconds) ¹	
	Full Span	Narrow Sweep
3700 Hz	.446	.150
3000 Hz	.447	.176
1000 Hz	.511	.312
300 Hz	.944	.980
100 Hz	2.25	2.070
30 Hz	7.57	7.240
10 Hz	21.98	21.600

¹ The listed sweep times correspond to an HP 8753D analyzer being set to a preset state for the full span, and 2 GHz to 3 GHz for the narrow span.

To Reduce the Averaging Factor

By reducing the averaging factor (number of sweeps) or switching off averaging, you can increase the analyzer's measurement speed. The time needed to compute averages can also slow the sweep time slightly, in narrow spans.

1. Press **AVG** **AVG FACTOR**.
2. Enter an averaging factor that is less than the value displayed on the analyzer screen and press **x1**.
3. If you want to switch off averaging, press **AVG** **AVERAGING OFF**.

To Reduce the Number of Measurement Points

1. Press **MENU** **NUMBER OF POINTS**.
2. Enter a number of points that is less than the value displayed on the analyzer screen and press **x1**.

The analyzer sweep time does not change proportionally with the number of points, but as indicated below.

Number of Points	Sweep Time (Seconds) ¹			
	Full Span		Narrow Span	
	LIN	LIST/LOG	LIN	LIST
51	0.35	0.57	0.09	0.25
101	0.39	0.77	0.12	0.43
201	0.43	1.11	0.17	0.78
401	0.49	1.73	0.27	1.33
801	0.69	3.04	0.47	2.64
1601	1.09	5.7	0.87	5.30

¹ The listed sweep times correspond to the analyzer being set to a preset state, with a 6 GHz span. A 3 GHz span would have faster sweep times.

To Set the Sweep Type

Different sweep speeds are associated with the following three types of non-power sweeps. Choose the sweep type that is most appropriate for your application.

1. Press **(MENU)** **SWEEP TYPE MENU**.
2. Select the sweep type:
 - Select **LIN FREQ** for the fastest sweep for a given number of fixed points.
 - Select **LIST FREQ** for the fastest sweep when specific non-linearly spaced frequency points are of interest.
 - Select **LOG FREQ** for the fastest sweep when the frequency points of interest are in the lower part of the frequency span selected.

To View a Single Measurement Channel

Viewing a single channel will increase the measurement speed if the analyzer's channels are in alternate, or uncoupled mode.

1. Press **(DISPLAY)** **DUAL CHAN OFF**.
2. Press **(CHAN 1)** and **(CHAN 2)** to alternately view the two measurement channels.

If you must view both measurement channels simultaneously (with dual channel), use the chop sweep mode, explained next.

To Activate Chop Sweep Mode

You can use the chop sweep mode to make two measurements at the same time. For example, the analyzer can measure A/R and B/R simultaneously. You can activate the chop mode by pressing **PRESET** or by the following the sequence below.

- Press **CAL** **MORE** **CHOP A** and **B**.

For more information, refer to “Alternate and Chop Sweep Modes” in Chapter 6.

To Use External Calibration

Offloading the error correction process to an external PC increases throughput on the network analyzer. This can be accomplished with remote only commands. Refer to the *HP 8753D Programmer's Guide* for information on how to use external calibration.

To Use Fast 2-Port Calibration

With the 2-port calibration on, faster measurements may be made by not measuring the reverse path for every forward sweep. This is controlled by the test set switch command.

When making measurements using full two-port error-correction, the following types of test set switching can be defined by the user:

- **Hold:** In this mode the analyzer does not switch between the test ports on every sweep. The measurement stays on the active port after an initial cycling between the ports. The fastest measurements can be made by using this type of test set switching. Pressing the **MEAS** key or changing to a different S-parameter measurement will cause the test set to switch and cycle between the ports.
- **Continuous:** In this mode the analyzer will switch between the test ports on every sweep. Although this type of test set switching provides the greatest measurement accuracy, it also takes the longest amount of time.
- **Number of Sweeps:** In this mode there is an initial cycling between the test ports and then the measurement stays on the active port for a user-defined number of sweeps. After the specified number of sweeps have been executed, the analyzer switches between the test ports and begins the cycle again. This type of test set switching can provide improved measurement accuracy over the hold mode and faster measurement speeds than continuous mode.

1. To access the test set switch functions, press:

CAL **MORE** **TEST SET SW**

2. To activate the hold mode, press:

0 **x1**

The analyzer will then display **TEST SET SW HOLD**.

3. To activate the continuous mode, press:

1 **x1**

The analyzer will then display **TEST SET SW CONTINUOUS**.

4. To enter the number of sweeps, press:

The analyzer will then display `TEST SET SW X SWEEPS`.

Increasing Dynamic Range

Dynamic range is the difference between the analyzer's maximum allowable input level and minimum measurable power. For a measurement to be valid, input signals must be within these boundaries. The dynamic range is affected by these factors:

- test port input power
- test port noise floor
- receiver crosstalk

To Increase the Test Port Input Power

You can increase the analyzer's source output power so that the test device output power is at the top of the measurement range of the analyzer test port.

Press **MENU** **POWER** and enter the new source power level, followed by **x1**.

Caution **TEST PORT INPUT DAMAGE LEVEL: +26 dBm**

To Reduce the Receiver Noise Floor

Since the dynamic range is the difference between the analyzer's input level and its noise floor, using the following techniques to lower the noise floor will increase the analyzer's dynamic range.

Changing System Bandwidth

Each tenfold reduction in IF (receiver) bandwidth lowers the noise floor by 10 dB. For example, changing the IF bandwidth from 3 kHz to 300 Hz, you will lower the noise floor by about 10 dB.

1. Press **AVG** **IF BW**.
2. Enter the bandwidth value that you want, followed by **x1**.

Changing Measurement Averaging

You can apply weighted averaging of successive measurement traces to remove the effects of random noise.

1. Press **AVG** **AVERAGING FACTOR**.
2. Enter a value followed by **x1**.
3. Press **AVERAGING ON**.

Refer to the "Application and Operation Concepts" chapter for more information on averaging.

Reducing Trace Noise

You can use two analyzer functions to help reduce the effect of noise on the data trace:

- activate measurement averaging
- reduce system bandwidth

To Activate Averaging

The noise is reduced with each new sweep as the effective averaging factor increments.

1. Press **(AVG) AVERAGING FACTOR**.
2. Enter a value followed by **(x1)**.
3. Press **AVERAGING ON**.

Refer to the “Application and Operation Concepts” chapter for more information on averaging.

To Change System Bandwidth

By reducing the system bandwidth, you reduce the noise that is measured during the sweep. While averaging requires multiple sweeps to reduce noise, narrowing the system bandwidth reduces the noise on each sweep.

1. Press **(AVG) IF BW**.
2. Enter the IF bandwidth value that you want, followed by **(x1)**.

Narrower system bandwidths cause longer sweep times. When in auto sweep time mode, the analyzer uses the fastest sweep time possible for any selected system bandwidth. Auto sweep time mode is the default (preset) analyzer setting.

Reducing Receiver Crosstalk

To reduce receiver crosstalk you can do the following:

- perform a response and isolation measurement calibration
- set the sweep to the alternate mode

Alternate sweep is intended for measuring wide dynamic range devices, such as high pass and bandpass filters. This sweep mode removes a type of leakage term through the device under test, from one channel to another.

To set the alternate sweep, press **(CAL) MORE ALTERNATE A AND B**.

Refer to the procedures, located earlier in this chapter for a response and isolation measurement calibration procedure.

Reducing Recall Time

To reduce time during recall and frequency changes, the raw offset function and the spur avoidance function can be turned off. To turn these functions off, press:

```
(SYSTEM) CONFIGURE MENU
RAW OFFSET OFF SPUR AVOID OFF
```

The raw offset function is normally on and controls the sampler and attenuator offsets. The spur avoidance function is normally on and generates values as part of the sampler offset table. The creation of this table takes considerable time during a recall of an instrument state.

To save time at recalls and during frequency changes, both functions should be turned off. This will avoid generating the sampler offset table.

Raw offsets may be turned on or off individually for each channel. They follow the channel coupling. For dual channel operation, raw offsets should be turned off for each channel if the channels are uncoupled. Spur avoidance is always coupled between channels, therefore both channels are turned on or off at the same time.

Note Both functions must be turned off to realize the recall time savings.

The following table lists the recall state times with the raw offsets and spur avoidance functions on or off.

Table 5-6. Typical Recall State Times

Operations	Channel	Points	Raw Offset Spur Avoid	Total Time (secs)	Recall Time (secs)
Recall and Sweep	Dual Chan.	1601	On	3.89	3.18
Recall and Sweep	Dual Chan.	1601	Off	2.008	1.298
Sweep only (no Recall)	Dual Chan.	1601	n/a	0.71	no recall
Recall and Sweep	Dual Chan.	201	On	0.955	.740
Recall and Sweep	Dual Chan.	201	Off	0.734	.519
Sweep only (no Recall)	Dual Chan.	201	n/a	0.215	no recall
Recall and Sweep	Single Chan.	1601	On	2.134	1.424
Recall and Sweep	Single Chan.	1601	Off	1.251	.541

Instrument State: CF= 1GHz, Span= 2MHz, Error Correction OFF. HP-IB commands sent for timing are Recall;OPC?;SING; or, for sweep only, OPC?;SING;.

Understanding Spur Avoidance

In the 400 MHz to 3 GHz range, where the source signal is created by heterodyning two higher frequency oscillators, unwanted spurious mixing products from the source may be present at the output. These spurs can become apparent in filter measurements when filters have greater than 80 dB rejection.

Spur avoidance slightly moves the frequency of both oscillators such that the source frequency remains the same but the spurious mixing products shift out of the measurement receiver range. The calculation of the exact frequency points where the shifting must occur (stored in the sampler offset table) increases the time needed to change or recall instrument states. Selecting `SPUR AVOID OFF` and `RAW OFFSET OFF` eliminates this calculation.

Application and Operation Concepts

This chapter provides conceptual information on the following primary operations and applications that are achievable with the HP 8753D network analyzer.

- HP 8753D System operation
- Data processing
- Active channel keys
- Entry block keys
- Stimulus functions
- Response functions
- S-parameters
- Display formats
- Scale reference
- Display functions
- Averaging
- Markers
- Measurement calibration
- Instrument state functions
- Time domain operation
- Test sequencing
- Amplifier measurements
- Mixer measurements
- Connection considerations
- Reference documents

Where to Look for More Information

Additional information about many of the topics discussed in this chapter is located in the following areas:

- Chapter 2, “Making Measurements,” contains step-by-step procedures for making measurements or using particular functions.
- Chapter 3, “Mixer Measurements,” contains step-by-step procedures for making measurements of mixers.
- Chapter 5, “Optimizing Measurement Results,” describes techniques and functions for achieving the best measurement results.
- Chapter 7, “Specifications and Measurement Uncertainties,” defines the performance capabilities of the analyzer.
- Chapter 8, “Menu Maps,” shows softkey menu relationships.
- Chapter 9, “Key Definitions,” describes all the front panel keys and softkeys.

HP 8753D System Operation

Network analyzers measure the reflection and transmission characteristics of devices and networks. A network analyzer test system consists of the following:

- source
- signal-separation devices
- receiver
- display

The analyzer applies a signal that is transmitted through the test device, or reflected from its input, and then compares it with the incident signal generated by the swept RF source. The signals are then applied to a receiver for measurement, signal processing, and display.

The HP 8753D vector network analyzer integrates a high resolution synthesized RF source, test set, and a dual channel three-input receiver to measure and display magnitude, phase, and group delay of transmitted and reflected power. With Option 010, the analyzer has the additional capability of transforming measured data from the frequency domain to the time domain. Other options are explained in Chapter 1, “HP 8753D Description and Options.” Figure 6-1 is a simplified block diagram of the network analyzer system. A detailed block diagram of the analyzer is provided in the *HP 8753D Network Analyzer Service Guide* together with a theory of system operation.

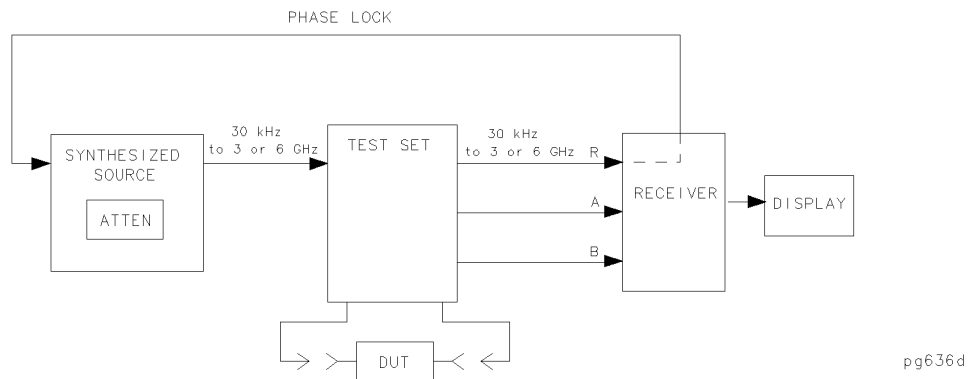

Figure 6-1. Simplified Block Diagram of the Network Analyzer System

The Built-In Synthesized Source

The analyzer’s built-in synthesized source produces a swept RF signal or CW (continuous wave) signal in the range of 30 kHz to 3.0 GHz. The HP 8753D Option 006 is able to generate signals up to 6 GHz. The RF output power is leveled by an internal ALC (automatic leveling control) circuit. To achieve frequency accuracy and phase measuring capability, the analyzer is phase locked to a highly stable crystal oscillator. For this purpose, a portion of the transmitted signal is routed to the R channel input of the receiver, where it is sampled by the phase detection loop and fed back to the source. Some portion of the RF source signal must always be sent to the R channel input. The level must be between 0 dB and -35 dBm.

The Source Step Attenuator

The step attenuator contained in the source is used to adjust the power level to the test device without changing the level of the incident power in the reference path.

The Built-In Test Set

The HP 8753D features a built-in test set that provides connections to the test device, as well as to the signal-separation devices. The signal separation devices are needed to separate the incident signal from the transmitted and reflected signals. The incident signal is applied to the R channel input through a jumper cable on the front panel. Meanwhile, the transmitted and reflected signals are internally routed from the test port couplers to the inputs of the A and B sampler/mixers in the receiver. Port 1 is connected to the A input and port 2 is connected to the B input.

The test set contains the hardware required to make simultaneous transmission and reflection measurements in both the forward and reverse directions. An RF path switch in the test set allows reverse measurements to be made without changing the connections to the test device.

The Receiver Block

The receiver block contains three sampler/mixers for the R, A, and B inputs. The signals are sampled, and mixed to produce a 4 kHz IF (intermediate frequency). A multiplexer sequentially directs each of the three signals to the ADC (analog to digital converter) where it is converted from an analog to a digital signal. The signals are then measured and processed for viewing on the display. Both amplitude and phase information are measured simultaneously, regardless of what is displayed on the analyzer.

The Microprocessor

A microprocessor takes the raw data and performs all the required error correction, trace math, formatting, scaling, averaging, and marker operations, according to the instructions from the front panel or over HP-IB. The formatted data is then displayed. The data processing sequence is described in “Data Processing” later in this chapter.

Required Peripheral Equipment

Measurements require calibration standards for vector accuracy enhancement (error-correction), and cables for interconnections. Model numbers and details of compatible power splitters, calibration kits, and cables are provided in Chapter 11, “Compatible Peripherals.”

Data Processing

The analyzer's receiver converts the R, A, and B input signals into useful measurement information. This conversion occurs in two main steps:

- The swept high frequency input signals are translated to fixed low frequency IF signals, using analog sampling or mixing techniques. (Refer to the *HP 8753D Network Analyzer Service Guide* for more details on the theory of operation.)
- The IF signals are converted into digital data by an analog to digital converter (ADC). From this point on, all further signal processing is performed mathematically by the analyzer microprocessors.

The following paragraphs describe the sequence of math operations and the resulting data arrays as the information flows from the ADC to the display. They provide a good foundation for understanding most of the response functions, and the order in which they are performed.

Figure 6-2 is a data processing flow diagram that represents the flow of numerical data from IF detection to display. The data passes through several math operations, denoted in the figure by single line boxes. Most of these operations can be selected and controlled with the front panel response block menus. The data, stored in arrays along the way and denoted by double line boxes, are places in the flow path where data is accessible via HP-IB.

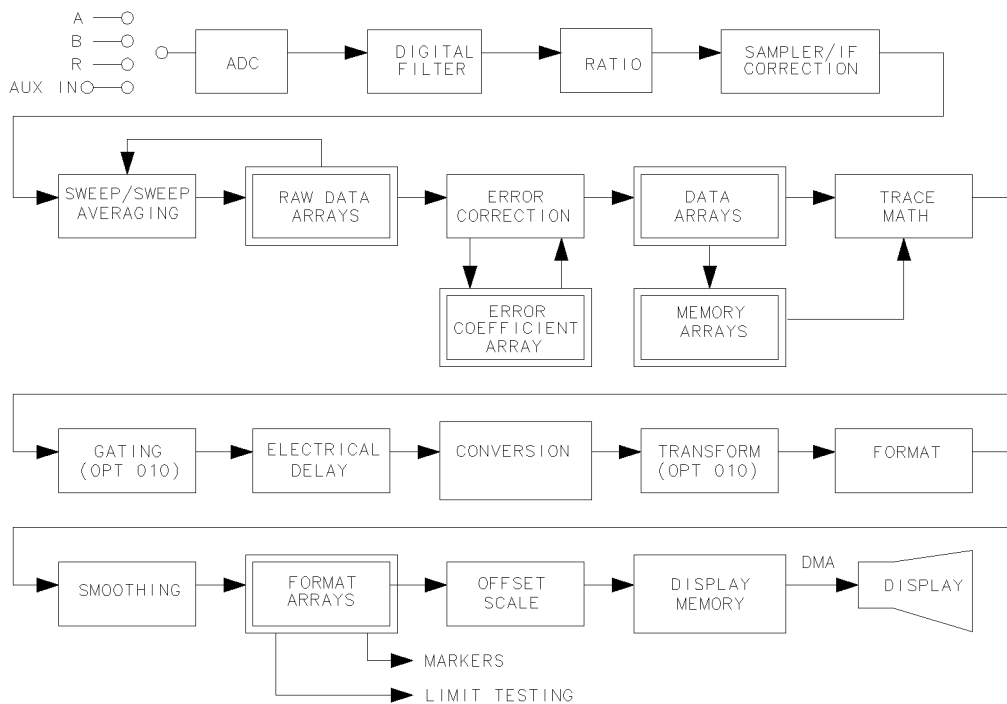

pg638d

Figure 6-2. Data Processing Flow Diagram

While only a single flow path is shown, two identical paths are available, corresponding to channel 1 and channel 2. When the channels are uncoupled, each channel is processed and controlled independently.

Data point definition: A “data point” or “point” is a single piece of data representing a measurement at a single stimulus value. Most data processing operations are performed point-by-point; some involve more than one point.

Sweep definition: A “sweep” is a series of consecutive data point measurements, taken over a sequence of stimulus values. A few data processing operations require that a full sweep of data is available. The number of points per sweep can be defined by the user. The units of the stimulus values (such as power, frequency, and time) can change, depending on the sweep mode, although this does not generally affect the data processing path.

Processing Details

The ADC

The ADC (analog-to-digital converter) converts the R, A, and B inputs (already down-converted to a fixed low frequency IF) into digital words. (The AUX INPUT connector on the rear panel is a fourth input.) The ADC switches rapidly between these inputs, so they are converted nearly simultaneously.

IF Detection

This detection occurs in the digital filter, which performs the discrete Fourier transform (DFT) on the digital words. The samples are converted into complex number pairs (real plus imaginary, $R+jX$). The complex numbers represent both the magnitude and phase of the IF signal. If the AUX INPUT is selected, the imaginary part of the pair is set to zero. The DFT filter shape can be altered by changing the IF bandwidth, which is a highly effective technique for noise reduction.

Ratio Calculations

These calculations are performed if the selected measurement is a ratio of two inputs (for example, A/R or B/R). This is a complex divide operation. If the selected measurement is absolute (such as A or B), no calculations are performed. The R, A, and B values are also split into channel data at this point.

Sampler/IF Correction

The next digital processing technique used is sampler/IF correction. This process digitally corrects for frequency response errors (both magnitude and phase, primarily sampler rolloff) in the analog down-conversion path.

Sweep-To-Sweep Averaging

Averaging is another noise reduction technique. This calculation involves taking the complex exponential average of several consecutive sweeps. This technique cannot be used with single-input measurements.

Pre-Raw Data Arrays

These data arrays store the results of all the preceding data processing operations. (Up to this point, all processing is performed real-time with the sweep by the IF processor. The remaining operations are not necessarily synchronized with the sweep, and are performed by the main processor.) When full 2-port error correction is on, the raw arrays contain all four S-parameter measurements required for accuracy enhancement. When the channels are uncoupled (`COUPLED CH OFF`), there may be as many as eight raw arrays. These arrays are directly accessible via HP-IB. Notice that the numbers here are still complex pairs.

Raw Arrays

Raw arrays contain the pre-raw data which has sampler and attenuator offset applied.

Vector Error-correction (Accuracy Enhancement)

Error-correction is performed next, if a measurement calibration has been performed and correction is activated. Error-correction removes repeatable systematic errors (stored in the error coefficient arrays) from the raw arrays. This can vary from simple vector normalization to full 12-term error-correction.

The results of error-correction are stored in the data arrays as complex number pairs. These are subsequently used whenever correction is on, and are accessible via HP-IB.

If the data-to-memory operation is performed, the data arrays are copied into the memory arrays.

Trace Math Operation

This operation selects either the data array, memory array, or both to continue flowing through the data processing path. In addition, the complex ratio of the two (data/memory) or the difference (data–memory) can also be selected. If memory is displayed, the data from the memory arrays goes through exactly the same processing flow path as the data from the data arrays.

Gating (Option 010 Only)

This digital filtering operation is associated with time domain transformation. Its purpose is to mathematically remove unwanted responses isolated in time. In the time domain, this can be viewed as a time-selective bandpass or bandstop filter. (If both data and memory are displayed, gating is applied to the memory trace only if gating was on when data was stored into memory.)

The Electrical Delay Block

This block involves adding or subtracting phase in proportion to frequency. This is equivalent to “line-stretching” or artificially moving the measurement reference plane. This block also includes the effects of port extensions as well as electrical delay.

Conversion

This converts the measured S-parameter data to the equivalent complex impedance (Z) or admittance (Y) values, or to inverse S-parameters ($1/S$).

Transform (Option 010 Only)

This transform converts frequency domain information into the time domain when it is activated. The results resemble time domain reflectometry (TDR) or impulse-response measurements. The transform uses the chirp-Z inverse fast Fourier transform (FFT) algorithm to accomplish the conversion. The windowing operation, if enabled, is performed on the

frequency domain data just before the transform. (A special transform mode is available to “demodulate” CW sweep data, with time as the stimulus parameter, and display spectral information with frequency as the stimulus parameter.)

Format

This operation converts the complex number pairs into a scalar representation for display, according to the selected format. This includes group delay calculations. These formats are often easier to interpret than the complex number representation. (Polar and Smith chart formats are not affected by the scalar formatting.) Notice in Figure 6-2 that after formatting, it is impossible to recover the complex data.

Smoothing

This noise reduction technique smoothes noise on the trace. Smoothing is also used to set the aperture for group delay measurements.

When smoothing is on, each point in a sweep is replaced by the moving average value of several adjacent (formatted) points. The number of points included depends on the smoothing aperture, which can be selected by the user. The effect is similar to video filtering. If data and memory are displayed, smoothing is performed on the memory trace only if smoothing was on when data was stored into memory.

Format Arrays

The data processing results are now stored in the format arrays. Notice in Figure 6-2 that the marker values and marker functions are all derived from the format arrays. Limit testing is also performed on the formatted data. The format arrays are accessible via HP-IB.

Offset and Scale

These operations prepare the formatted data for display. This is where the reference line position, reference line value, and scale calculations are performed, as appropriate to the format.

Display Memory

The display memory stores the display image for presentation on the analyzer. The information stored includes graticules, annotation, and softkey labels. If user display graphics are written, these are also stored in display memory. When a print or plot is made, the information is taken from display memory.

The display is updated frequently and synchronously with the data processing operations.

Active Channel Keys

The analyzer has two digital channels for independent measurements. Two different sets of data can be measured simultaneously, for example, the reflection and transmission characteristics of a device, or one measurement with two different frequency spans. The analyzer can separately, or simultaneously, show the data.

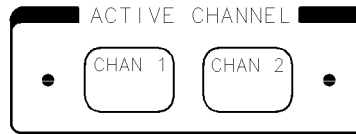

pg6261d

Figure 6-3. Active Channel Keys

The **CHAN 1** and **CHAN 2** keys shown in Figure 6-3 allow you to select the “active channel.” The front panel keys currently allow you to control the active channel. All of the channel-specific functions that you select apply to the active channel. The current active channel is indicated by an amber LED adjacent to the corresponding channel key.

Dual Channel

The analyzer has dual channel capability, so that you can view both the active and inactive channel traces, either overlaid or on separate graticules one above the other (split display). The dual channel and split display features are available in the display menus. Refer to “Display Menu” later in this chapter for illustrations and descriptions of the different display capabilities.

Uncoupling Stimulus Values Between Channels

You can uncouple the stimulus values between the two display channels by pressing **COUPLED CH OFF**. This allows you to assign different stimulus values for each channel; it’s almost like having the use of a second analyzer. The coupling and uncoupling of the stimulus values for the two channels are independent of the display and marker functions. Refer to “Channel Stimulus Coupling” later in this chapter for a listing of the stimulus parameters associated with the coupled channel mode.

Coupled Markers

Measurement markers can have the same stimulus values (coupled) for the two channels, or they can be uncoupled for independent control in each channel. Refer to “Markers” later in this chapter for more information about markers.

Entry Block Keys

The entry block, illustrated in Figure 6-4, includes the numeric and units keypad, the knob, and the step keys. You can use these in combination with other front panel keys and softkeys for the following reasons:

- to modify the active entry
- to enter or change numeric data
- to change the value of the active marker

Generally, the keypad, knob, and step keys can be used interchangeably.

Before you can modify a function, you must activate the particular function by pressing the corresponding front panel key or softkey. Then you can modify the value directly with the knob, the step keys, or the digits keys and a terminator.

If no other functions are activated, the knob moves the active marker.

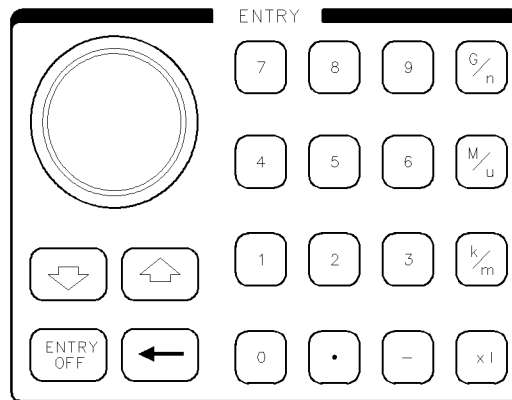

pg6133d

Figure 6-4. Entry Block

Units Terminator

The units terminator keys are the four keys in the right column of the keypad. You must use these keys to specify units of numerical entries from the keypad. A numerical entry is incomplete until a terminator is supplied. The analyzer indicates that an input is incomplete by a data entry arrow ← pointing at the last entered digit in the active entry area. When you press the units terminator key, the arrow is replaced by the units you selected. The units are abbreviated on the terminator keys as follows:

G/n = Giga/nano ($10^9 / 10^{-9}$)

M/μ = Mega/micro ($10^6 / 10^{-6}$)



k/m = kilo/milli ($10^3 / 10^{-3}$)

x1 = basic units: dB, dBm, degrees, seconds, Hz, or dB/GHz (may be used to terminate unitless entries such as averaging factor)

Knob



You can use the knob to make continuous adjustments to current measurement parameter values or the active marker position. Values changed by the knob are effective immediately, and require no units terminator.

Step Keys

You can use the step keys  (up) and  (down) to step the current value of the active function up or down. The analyzer defines the steps for different functions. No units terminator is required. For editing a test sequence, you can use these keys to scroll through the displayed sequence.

You can use this key to clear and turn off the active entry area, as well as any displayed prompts, error messages, or warnings. Use this function to clear the display before printing or plotting. This key also helps prevent changing active values accidentally by moving the knob.

You can use this key to delete the last entry, or the last digit entered from the numeric keypad. You can also use this key in one of two ways for modifying a test sequence:

- deleting a single-key command that you may have pressed by mistake (for example `Trans:FWD S21 (B/R)`)
- deleting the last digit in a series of digits that you may have input, as long as you haven't yet pressed a terminator (for example if you pressed   but did not press , etc)

You can use this key to add a decimal point to the number you entered.

You can use this key to add a minus sign to the number you entered.

Stimulus Functions

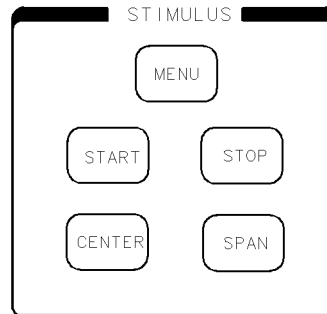

pg6117d

Figure 6-5. Stimulus Function Block

The stimulus function block keys are used to define the source RF output signal to the test device by providing control of the following parameters:

- swept frequency ranges
- time domain start and stop times (Option 010 Only)
- power sweep start and stop values
- RF power level and power ranges
- sweep time
- sweep trigger
- number of data points
- channel and test port coupling
- CW frequency
- sweep type

Defining Ranges with Stimulus Keys

The **START**, **STOP**, **CENTER**, and **SPAN** keys are used to define the swept frequency range, time domain range (Option 010), or power sweep range. The range can be expressed as either start/stop or center/span. When one of these keys is pressed, its function becomes the active function. The value is displayed in the active entry area and can be changed with the knob, step keys, or numeric keypad. Current stimulus values for the active channel are also displayed along the bottom of the graticule. Frequency values can be blanked for security purposes, using the display menus.

The preset stimulus mode is frequency, and the start and stop stimulus values are set to 30 kHz and 3 GHz (or 6 GHz with Option 006) respectively. In the time domain (Option 010) or in CW time mode, the stimulus keys refer to time (with certain exceptions). In power sweep, the stimulus value is in dBm.

Because the display channels are independent, the stimulus signals for the two channels can be uncoupled and their values set independently. The values are then displayed separately if the instrument is in dual channel display mode. In the uncoupled mode with dual channel display the instrument takes alternate sweeps to measure the two sets of data. Channel stimulus

coupling is explained in the “Stimulus Menu” section, and dual channel display capabilities are explained in the “Display Menu” section located later in this chapter.

Stimulus Menu

The **MENU** key provides access to the stimulus menu, which consists of softkeys that activate stimulus functions or provide access to additional menus. These softkeys are used to define and control all stimulus functions other than start, stop, center, and span. The following softkeys are located within the stimulus menu:

- **POWER** provides access to the power menu.
- **SWEEP TIME** allows you to specify the sweep time.
- **TRIGGER MENU** provides access to the trigger menu.
- **NUMBER of POINTS** allows you to specify the number of measurement points per sweep.
- **MEASURE RESTART** allows you to cause the current measurement to abort and a new measurement to begin. With two-port error-correction activated, pressing this softkey causes all four S-parameters to be remeasured.
- **COUPLED CH ON off** allows you to couple or uncouple the stimulus functions of the two display channels.
- **CW FREQ** allows you to specify the CW frequency.
- **SWEEP TYPE MENU** provides access to the sweep type menu.

The Power Menu

The power menu is used to define and control analyzer power. It consists of the following softkeys:

- **PWR RANGE AUTO man** allows you to select power ranges automatically or manually.
- **POWER RANGES** provides access to the power range menu.
- **SLOPE** compensates for power loss versus the frequency sweep, by sloping the output power upwards proportionally to frequency.
- **SLOPE on OFF** toggles the power slope function on or off.
- **SOURCE PWR ON off** allows you to switch the source power on or off. When a power trip occurs, the trip is reset by selecting **SOURCE PWR ON**.
- **CHAN PWR [COUPLED]** allows you to couple or uncouple channel power.
- **PORT POWER** allows you to couple or uncouple port power.

Understanding the Power Ranges

The built-in synthesized source contains a programmable step attenuator that allows you to directly and accurately set power levels in eight different power ranges. Each range has a total span of 25 dB. The eight ranges cover the instrument's full operating range from +10 dBm to -85 dBm (see Figure 6-6). A power range can be selected either manually or automatically.

Automatic mode

If you select **PWR RANGE AUTO**, you can enter any power level within the total operating range of the instrument and the source attenuator will automatically switch to the corresponding range.

Each range overlaps its adjacent ranges by 15 dB, therefore, certain power levels are designated to cause the attenuator to switch to the next range so that optimum (leveled) performance is maintained. These transition points exist at -10 dB from the top of a range and at +5 dB from the bottom of a range. This leaves 10 dB of operating range. By turning the RPG knob with **PORT POWER** being the active function, you can hear the attenuator switch as these transitions occur (see Figure 6-6).

Manual mode

If you select **PWR RANGE MAN**, you must first enter the power ranges menu and manually select the power range that corresponds to the power level you want to use. This is accomplished by pressing the **POWER RANGES** softkey and then selecting one of the twelve available ranges. In this mode, you will not be able to use the step keys, front panel knob, or keypad entry to select power levels outside the range limits. This feature is necessary to maintain accuracy once a measurement calibration is activated.

When a calibration is active, the power range selection is switched from auto to manual mode, and **PRM** appears on the display.

Note

After measurement calibration, you can change the power within a range and still maintain nearly full accuracy. In some cases better accuracy can be achieved by changing the power within a range. It can be useful to set different power levels for calibration and measurement to minimize the effects of sampler compression or noise floor.

If you decide to switch power ranges, the calibration is no longer valid and accuracy is no longer specified. However, the analyzer leaves the correction *on* even though it's invalid.

The annotation C? will be displayed whenever you change the power after calibration.

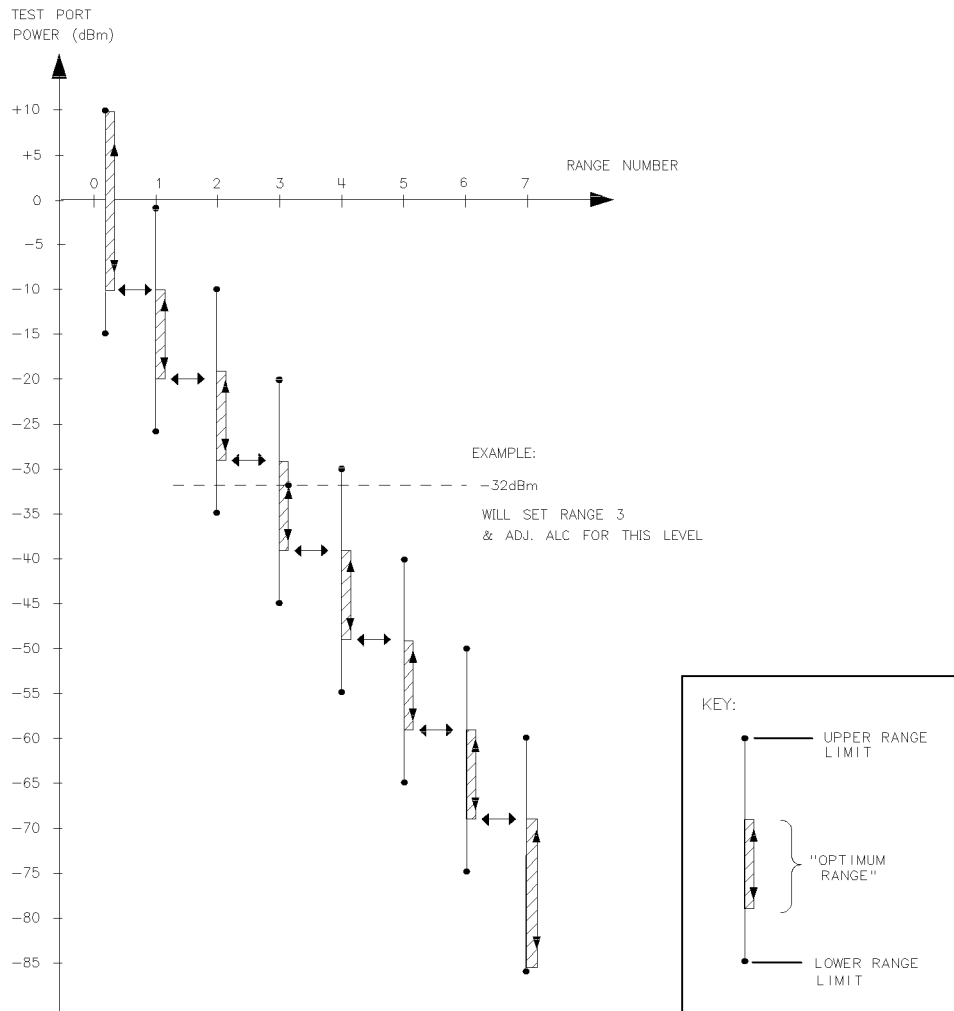

pg6154d

Figure 6-6. Power Range Transitions in the Automatic Mode

Power Coupling Options

There are two methods you can use to couple and uncouple power levels with the HP 8753D:

- channel coupling
- port coupling

By uncoupling the channel powers, you effectively have two separate sources. Uncoupling the test ports allows you to have different power levels on each port.

Channel coupling

`CHAN POWER [COUPLED]` toggles between coupled and uncoupled channel power. With the channel power coupled, the power levels are the same on each channel. With the channel power uncoupled, you can set different power levels for each channel. For the channel power to be uncoupled, the other channel stimulus functions must also be uncoupled (`COUPLED CH OFF`).

Test port coupling

`PORT POWER [COUPLED]` toggles between coupled and uncoupled test ports. With the test ports coupled, the power level is the same at each port. With the ports uncoupled, you can set a different power level at each port. This can be useful, for example, if you want to simultaneously perform a gain and reverse isolation measurement on a high-gain amplifier using the dual channel mode to display the results. In this case, you would want the power in the forward direction (S_{21}) much lower than the power in the reverse direction (S_{12}).

Sweep Time

The **SWEEP TIME** softkey selects sweep time as the active entry and shows whether the automatic or manual mode is active. The following explains the difference between automatic and manual sweep time:

- **Manual sweep time.** As long as the selected sweep speed is within the capability of the instrument, it will remain fixed, regardless of changes to other measurement parameters. If you change measurement parameters such that the instrument can no longer maintain the selected sweep time, the analyzer will change to the fastest sweep time possible.
- **Auto sweep time.** Auto sweep time continuously maintains the fastest sweep speed possible with the selected measurement parameters.

Sweep time refers only to the time that the instrument is sweeping and taking data, and does not include the time required for internal processing of the data, retrace time, or bandswitching time. A sweep speed indicator ↑ is displayed on the trace for sweep times longer than 1.0 second. For sweep times faster than 1.0 second the ↑ indicator appears in the status notations area at the left of the analyzer's display.

Manual Sweep Time Mode

When this mode is active, the softkey label reads **SWEEP TIME [MANUAL]**. This mode is engaged whenever you enter a sweep time greater than zero. This mode allows you to select a fixed sweep time. If you change the measurement parameters such that the current sweep time is no longer possible, the analyzer will automatically increase to the next fastest sweep time possible. If the measurement parameters are changed such that a faster sweep time is possible, the analyzer will not alter the sweep time while in this mode.

Auto Sweep Time Mode

When this mode is active, the softkey label reads **SWEEP TIME [AUTO]**. This mode is engaged whenever you enter **0 [x1]** as a sweep time. Auto sweep time continuously maintains the fastest sweep time possible with the selected measurement parameters.

Minimum Sweep Time

The minimum sweep time is dependent on the following measurement parameters:

- the number of points selected
- IF bandwidth
- sweep-to-sweep averaging in dual channel display mode
- error-correction
- type of sweep

In addition to the parameters listed above, the actual **cycle time** of the analyzer is also dependent on the following measurement parameters:

- smoothing
- limit test
- trace math
- marker statistics

- time domain (Option 010 Only)

Use Table 6-1 to determine the minimum cycle time for the listed measurement parameters. The values listed represent the minimum time required for a CW time measurement with averaging off.

Table 6-1. Minimum Cycle Time (in seconds)

Number of Points	IF Bandwidth						
	3700 Hz	3000 Hz	1000 Hz	300 Hz	100 Hz	30 Hz	10 Hz
11	0.0041 s	0.0055 s	0.012 s	0.037 s	0.108 s	0.359 s	1.14 s
51	0.0191 s	0.0255 s	0.060 s	0.172 s	0.504 s	1.660 s	5.30 s
101	0.0379 s	0.0505 s	0.120 s	0.341 s	0.998 s	3.300 s	10.5 s
201	0.0754 s	0.1005 s	0.239 s	0.679 s	1.990 s	6.600 s	20.9 s
401	0.1504 s	0.2005 s	0.476 s	1.355 s	3.960 s	13.10 s	41.7 s
801	0.3004 s	0.4005 s	0.951 s	2.701 s	7.910 s	26.10 s	83.3 s
1601	0.6004 s	0.8005 s	1.901 s	5.411 s	15.80 s	52.20 s	166.5 s

Trigger Menu

The trigger menu is used to select the type and number of groups for the sweep trigger. The following is a description of the softkeys located within this menu:

- **HOLD** freezes the data trace on the display, and the analyzer stops sweeping and taking data. The notation "Hld" is displayed at the left of the graticule. If the ↑ indicator is on at the left side of the display, trigger a new sweep with **SINGLE**.
- **SINGLE** takes one sweep of data and returns to the hold mode.
- **NUMBER of GROUPS** triggers a user-specified number of sweeps, and returns to the hold mode. This function can be used to override the test set hold mode (indicated by the notation "tsH" at the left of the screen). In this mode, the electro-mechanical transfer switch (Option 007) and attenuator are not protected against unwanted continuous switching. This occurs in a full two-port calibration, in a measurement of two different parameters that require power out from both ports, or when the channels are uncoupled and a different power level is set for each channel.

If averaging is on, the number of groups should be at least equal to the averaging factor selected, to allow measurement of a fully averaged trace. Entering a number of groups resets the averaging counter to 1.

- **CONTINUOUS** is the standard sweep mode. The sweep is triggered automatically and continuously and the trace is updated with each sweep.
- **TRIGGER: TRIG OFF** switches off external trigger mode.
- **EXT TRIG ON SWEEP** is used when the sweep is triggered on an externally generated signal that is connected to the rear panel EXT TRIGGER input. The sweep is started with a high to low transition of a TTL signal. If this key is pressed when no external trigger signal is connected, the notation "Ext" is displayed at the left side of the display to indicate that the analyzer is waiting for a trigger. When a trigger signal is connected, the "Ext" notation is replaced by the sweep speed indicator either in the status notations area or on the trace. External trigger mode is allowed in every sweep mode.
- **EXT TRIG ON POINT** is similar to the trigger on sweep, but triggers on each data point in a sweep.
- **MANUAL TRG ON POINT** waits for a manual trigger for each point. Subsequent pressing of this softkey triggers each measurement. The annotation "man" appears at the left side of the display when the instrument is waiting for the trigger to occur. This feature is useful in a test sequence when an external device or instrument requires changes at each point.

Source Attenuator Switch Protection

The programmable step attenuator of the source can be switched between port 1 and port 2 when the test port power is uncoupled or between channel 1 and channel 2 when the channel power is uncoupled. To avoid premature wear of the attenuator, measurement configurations requiring continuous switching between different power ranges are not allowed.

For example, channels 1 and 2 of the analyzer are decoupled, power levels in two different ranges are selected for each channel, and dual channel display is engaged. To prevent continuous switching between the two power ranges, the analyzer automatically engages the test set hold mode after measuring both channels once. The active channel continues to be updated each sweep while the inactive channel is placed in the hold mode. (The status annotation `tsH` appears on the left side of the display.) If averaging is on, the test set hold mode does not engage until the specified number of sweeps is completed. The `MEASURE RESTART` and `NUMBER OF GROUPS` (see “Trigger Menu”) softkeys can override this protection feature.

Allowing Repetitive Switching of the Attenuator

The `MEASURE RESTART` and `NUMBER OF GROUPS` (see “Trigger Menu”) softkeys allow measurements which demand repetitive switching of the step attenuator. Use these softkeys with caution; repetitive switching can cause premature wearing of the attenuator.

- `MEASURE RESTART` causes one measurement to occur before activating the test set hold mode.
- `NUMBER OF GROUPS` (see “Trigger Menu”) causes a specified number of measurements to occur before activating the test set hold mode.

Channel Stimulus Coupling

COUPLED CH on OFF toggles the channel coupling of stimulus values. With **COUPLED CH ON** (the preset condition), both channels have the same stimulus values. (The inactive channel takes on the stimulus values of the active channel.)

In the stimulus coupled mode, the following parameters are coupled:

- frequency
- number of points
- source power
- number of groups
- IF bandwidth
- sweep time
- trigger type
- gating parameters
- sweep type
- power meter calibration

Coupling of stimulus values for the two channels is independent of **DUAL CHAN on OFF** in the display menu and **MARKERS: UNCOUPLED** in the marker mode menu. **COUPLED CH OFF** activates an alternate sweep function when dual channel display is on. In this mode the analyzer alternates between the two sets of stimulus values and displays the measurement data of both channels.

Sweep Type Menu

The following softkeys are located within the sweep type menu. Among them are the five sweep types available.

- **LIN FREQ** (linear frequency sweep).
- **LOG FREQ** (logarithmic frequency sweep).
- **LIST FREQ** (list frequency sweep) provides access to the single/all segment menu.
- **POWER SWEEP**.
- **CW TIME** (CW time sweep).
- **EDIT LIST** allows list frequencies to be entered or modified using the edit list menu and edit subsweep menu.

The following sweep types will function with the interpolated error-correction feature (described later):

- linear frequency
- power sweep
- CW time

The following sweep types will not function with the interpolated error correction feature (described later):

- logarithmic frequency sweep
- list frequency sweep

Linear Frequency Sweep (Hz)

The **LIN FREQ** softkey activates a linear frequency sweep that is displayed on a standard graticule with ten equal horizontal divisions. This is the preset default sweep type.

For a linear sweep, sweep time is combined with the channel's frequency span to compute a source sweep rate:

$$\text{sweep rate} = (\text{frequency span}) / (\text{sweep time})$$

Since the sweep time may be affected by various factors, the equation provided here is merely an indication of the ideal (fastest) sweep rate. If the user-specified sweep time is greater than 15 ms times the number of points, the sweep changes from a continuous ramp sweep to a stepped CW sweep. Also, for 10 Hz or 30 Hz IF bandwidths the sweep is automatically converted to a stepped CW sweep.

In the linear frequency sweep mode it is possible, with Option 010, to transform the data for time domain measurements using the inverse Fourier transform technique.

Logarithmic Frequency Sweep (Hz)

The `LOG FREQ` softkey activates a logarithmic frequency sweep mode. The source is stepped in logarithmic increments and the data is displayed on a logarithmic graticule. This is slower than a continuous sweep with the same number of points, and the entered sweep time may therefore be changed automatically. For frequency spans of less than two octaves, the sweep type automatically reverts to linear sweep.

List Frequency Sweep (Hz)

The `LIST FREQ` softkey provides a user-definable arbitrary frequency list mode. This list is defined and modified using the edit list menu and the edit subsweep menu. Up to 30 frequency subsweeps (called “segments”) of several different types can be specified, for a maximum total of 1632 points. One list is common to both channels. Once a frequency list has been defined and a measurement calibration performed on the full frequency list, one or all of the frequency segments can be measured and displayed without loss of calibration.

When the `LIST FREQ` key is pressed, the network analyzer sorts all the defined frequency segments into CW points in order of increasing frequency. It then measures each point and displays a single trace that is a composite of all data taken. If duplicate frequencies exist, the analyzer makes multiple measurements on identical points to maintain the specified number of points for each subsweep. Since the frequency points may not be distributed evenly across the display, the display resolution may be uneven, and more compressed in some parts of the trace than in others. However, the stimulus and response readings of the markers are always accurate. Because the list frequency sweep is a stepped CW sweep, the sweep time is slower than for a continuous sweep with the same number of points.

Segment Menu

The `LIST FREQ` softkey provides access to the segment menu, which allows you to select any single segment (`SINGLE SEG SWEEP`) in the frequency list or all of the segments (`ALL SEGS SWEEP`) in the frequency list.

Refer to “Modifying List Frequencies” in this section for information on how to enter or modify the list frequencies. If no list has been entered, the message `CAUTION: LIST TABLE EMPTY` is displayed.

A tabular printout of the frequency list data can be obtained using the `LIST VALUES` function in the copy menu.

Power Sweep (dBm)

The **POWER SWEEP** softkey turns on a power sweep mode that is used to characterize power-sensitive circuits. In this mode, power is swept at a single frequency, from a start power value to a stop power value, selected using the **(START)** and **(STOP)** keys and the entry block. This feature is convenient for such measurements as gain compression or AGC (automatic gain control) slope. To set the frequency of the power sweep, use **CW FREQ** in the stimulus menu.

The span of the swept power is limited to being equal to or within one of the eight pre-defined power ranges. The attenuator will not switch to a different power range while in the power sweep mode. Therefore, when performing a power sweep, power range selection will automatically switch to the *manual* mode.

In power sweep, the entered sweep time may be automatically changed if it is less than the minimum required for the current configuration (number of points, IF bandwidth, averaging, etc.).

CW Time Sweep (Seconds)

The **CW TIME** softkey turns on a sweep mode similar to an oscilloscope. The analyzer is set to a single frequency, and the data is displayed versus time. The frequency of the CW time sweep is set with **CW FREQ** in the stimulus menu. In this sweep mode, the data is continuously sampled at precise, uniform time intervals determined by the sweep time and the number of points minus 1. The entered sweep time may be automatically changed if it is less than the minimum required for the current instrument configuration.

In time domain using Option 010, the CW time mode data is translated to frequency domain, and the x-axis becomes frequency. In this mode, the instrument can be used as a spectrum analyzer to measure signal purity, or for low frequency (<1 kHz) analysis of amplitude or pulse modulation signals.

Selecting Sweep Modes

In addition to the previous sweep types, there are also two different sweep modes. These can be accessed through the correction menu by pressing **(CAL)** **MORE** **ALTERNATE A** and **B** or **CHOP A** and **B**. Refer to “Alternate and Chop Sweep Modes” in the “Measurement Calibration” section.

Modifying List Frequencies

List frequencies can be entered or modified using the edit list and edit subsweep menus. Application of the functions in these menus is described below.

Edit list menu

The **EDIT LIST** softkey within the sweep type menu provides access to the edit list menu.

This menu is used to edit the list of frequency segments (subsweeps) defined with the edit subsweep menu, described next. Up to 30 frequency subsweeps can be specified, for a maximum of 1632 points. The segments do not have to be entered in any particular order: the analyzer automatically sorts them and shows them on the display in increasing order of start frequency. This menu determines which entry on the list is to be modified, while the edit subsweep menu is used to make changes in the frequency or number of points of the selected entry.

Edit subsweep menu

Using the **EDIT** or **ADD** softkey within the edit list menu will display the edit subsweep menu. This menu lets you select measurement frequencies arbitrarily. Using this menu it is possible to define the exact frequencies to be measured on a point-by-point basis. For example the sweep could include 100 points in a narrow passband, 100 points across a broad stop band, and 50 points across the third harmonic response. The total sweep is defined with a list of subsweeps.

The frequency subsweeps, or segments, can be defined in any of the following terms:

- start/stop/number of points
- start/stop/step
- center/span/number of points
- center/span/step
- CW frequency

The subsweeps can overlap, and do not have to be entered in any particular order. The analyzer sorts the segments automatically and lists them on the display in order of increasing start frequency, even if they are entered in center/span format. If duplicate frequencies exist, the analyzer makes multiple measurements on identical points to maintain the specified number of points for each subsweep. The data is shown on the display as a single trace that is a composite of all data taken. The trace may appear uneven because of the distribution of the data points, but the frequency scale is linear across the total range.

Once the list frequencies have been defined or modified, the list frequency sweep mode can be selected with the **LIST FREQ** softkey in the sweep type menu (see “List Frequency Sweep”). The frequency list parameters can also be saved with an instrument state.

Response Functions

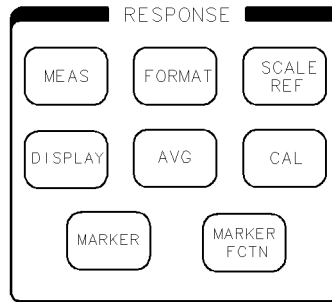

pg6118d

Figure 6-7. Response Function Block

The following response function block keys are used to define and control the following functions of the *active channel*.

- **MEAS**: measurement parameters
- **FORMAT**: data format
- **SCALE REF** **DISPLAY**: display functions
- **AVG**: noise reduction alternatives
- **CAL**: calibration functions
- **MARKER** **MARKER FCTN**: display markers

The current values for the major response functions of the active channel are displayed in specific locations along the top of the display. In addition, certain functions accessed through the keys in this block are annotated in the status notations area at the left side of the display. An illustration of the analyzer's display showing the locations of these information labels is provided in Chapter 1, "HP 8753D Description and Options."

S-Parameters

The **MEAS** key provides access to the S-parameter menu which contains softkeys that can be used to select the parameters or inputs that define the type of measurement being performed.

Understanding S-Parameters

S-parameters (scattering parameters) are a convention used to characterize the way a device modifies signal flow. A brief explanation of the S-parameters of a two-port device is provided here. For additional details refer to Hewlett-Packard Application Notes A/N 95-1 and A/N 154.

S-parameters are always a ratio of two complex (magnitude and phase) quantities. S-parameter notation identifies these quantities using the numbering convention:

S out in

where the first number (out) refers to the test-device port where the signal is emerging and the second number (in) is the test-device port where the signal is incident. For example, the S-parameter S_{21} identifies the measurement as the complex ratio of the signal emerging at the test device's port 2 to the signal incident at the test device's port 1.

Figure 6-8 is a representation of the S-parameters of a two-port device, together with an equivalent flowgraph. In the illustration, "a" represents the signal entering the device and "b" represents the signal emerging. Note that a and b are not related to the A and B input ports on the analyzer.

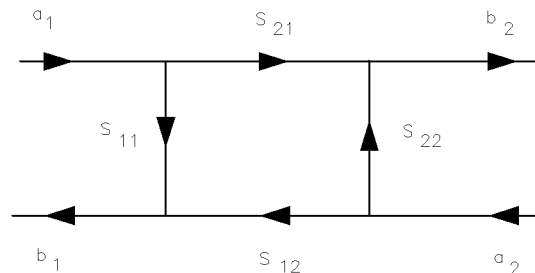
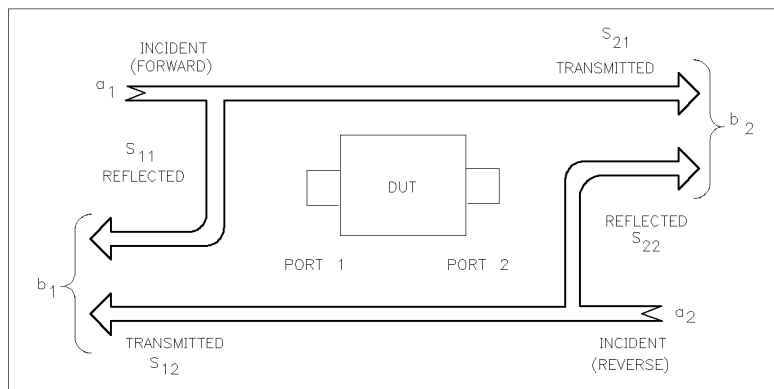

pg639d

Figure 6-8. S-Parameters of a Two-Port Device

S-parameters are exactly equivalent to the more common description terms below, requiring only that the measurements be taken with all test device ports properly terminated.

S-Parameter	Definition	Test Set Description	Direction
S_{11}	$\frac{b_1}{a_1} \quad a_2 = 0$	Input reflection coefficient	FWD
S_{21}	$\frac{b_2}{a_1} \quad a_2 = 0$	Forward gain	FWD
S_{12}	$\frac{b_1}{a_2} \quad a_1 = 0$	Reverse gain	REV
S_{22}	$\frac{b_2}{a_2} \quad a_1 = 0$	Output reflection coefficient	REV

The S-Parameter Menu

The S-parameter menu allows you to define the input ports and test set direction for S-parameter measurements. The analyzer automatically switches the direction of the measurement according to the selections you made in this menu. Therefore, the analyzer can measure all four S-parameters with a single connection. The S-parameter being measured is labeled at the top left corner of the display.

The S-parameter menu contains the following softkeys:

- Refl: FWD S11 (A/R)
- Trans: FWD S21 (B/R)
- Trans: REV S12 (A/R)
- Refl: REV S22 (B/R)
- ANALOG IN Aux Input
- CONVERSION [] provides access to the conversion menu.
- INPUT PORTS provides access to the input ports menu.

Analog In Menu

This menu allows you to monitor voltage and frequency nodes, using the analog bus and internal counter. For more information, refer to Chapter 10, “Service Key Menus and Error Messages” in the *HP 8753D Network Analyzer Service Guide*.

Conversion Menu

This menu converts the measured reflection or transmission data to the equivalent complex impedance (Z) or admittance (Y) values. This is not the same as a two-port Y or Z parameter conversion, as only the measured parameter is used in the equations. Two simple one-port conversions are available, depending on the measurement configuration.

An S_{11} or S_{22} trace measured as reflection can be converted to equivalent parallel impedance or admittance using the model and equations shown in Figure 6-9.

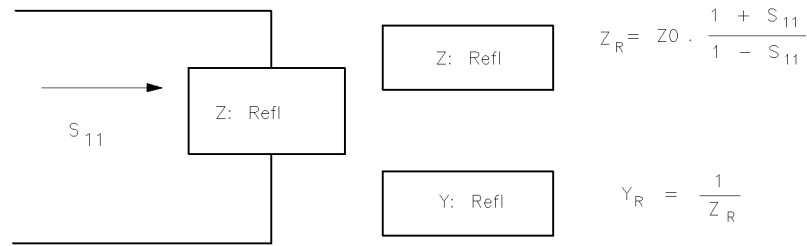

pg640d

Figure 6-9. Reflection Impedance and Admittance Conversions

In a transmission measurement, the data can be converted to its equivalent series impedance or admittance using the model and equations shown in Figure 6-10.

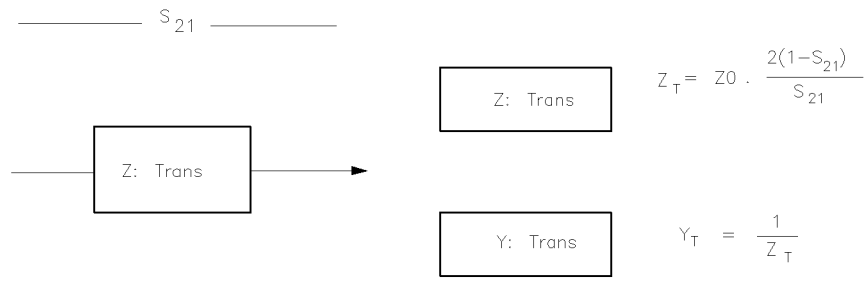

pg641d

Figure 6-10. Transmission Impedance and Admittance Conversions

Note Avoid the use of Smith chart, SWR, and delay formats for display of Z and Y conversions, as these formats are not easily interpreted.

Input Ports Menu

This menu allows you to define the input ports for power ratio measurements, or a single input for magnitude only measurements of absolute power. You cannot use single inputs for phase or group delay measurements, or any measurements with averaging activated.

The Format Menu

The **FORMAT** key provides access to the format menu. This menu allows you to select the appropriate display format for the measured data. The following list identifies which formats are available by means of which softkeys:

- **LOG MAG**
- **PHASE**
- **DELAY**
- **SMITH CHART**
- **POLAR**
- **LIN MAG**
- **SWR**
- **REAL**
- **IMAGINARY**

The analyzer automatically changes the units of measurement to correspond with the displayed format. Special marker menus are available for the polar and Smith formats, each providing several different marker types for readout of values.

The selected display format of a particular S-parameter or input is assigned to that parameter. Thus if different S-parameters are measured, even if only one channel is used, each parameter is shown in its selected format each time it is displayed.

The illustrations below show a reflection measurement of a bandpass filter displayed in each of the available formats.

Log Magnitude Format

The **LOG MAG** softkey displays the log magnitude format. This is the standard Cartesian format used to display magnitude-only measurements of insertion loss, return loss, or absolute power in dB versus frequency. Figure 6-11 illustrates the bandpass filter reflection data in a log magnitude format.

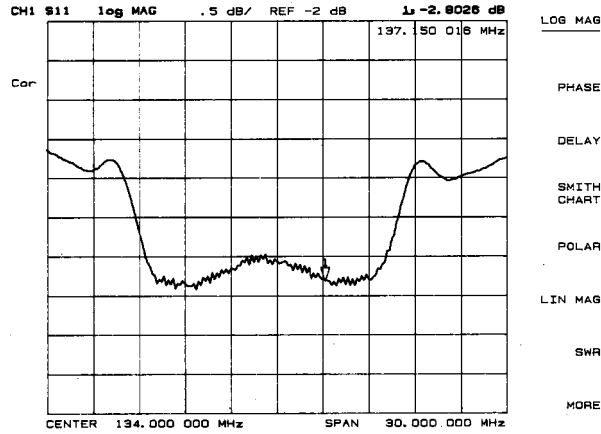

pg6184_c

Figure 6-11. Log Magnitude Format

Phase Format

The **PHASE** softkey displays a Cartesian format of the phase portion of the data, measured in degrees. This format displays the phase shift versus frequency. Figure 6-12 illustrates the phase response of the same filter in a phase-only format.

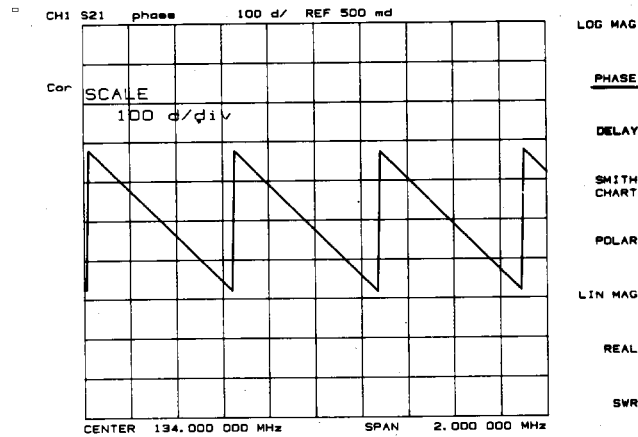

pg6178_c

Figure 6-12. Phase Format

Group Delay Format

The **DELAY** softkey selects the group delay format, with marker values given in seconds. Figure 6-13 shows the bandpass filter response formatted as group delay. Group delay principles are described in the next few pages.

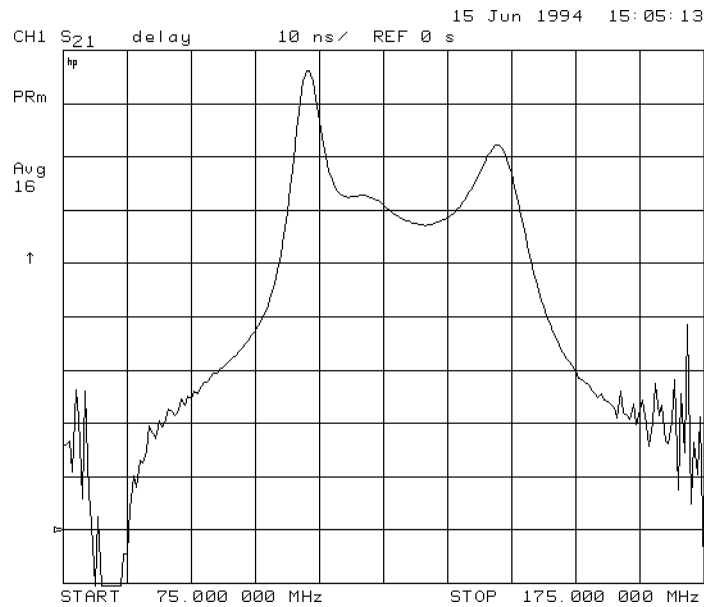

Figure 6-13. Group Delay Format

Smith Chart Format

The **SMITH CHART** softkey displays a Smith chart format (see Figure 6-14). This is used in reflection measurements to provide a readout of the data in terms of impedance. The intersecting dotted lines on the Smith chart represent constant resistance and constant reactance values, normalized to the characteristic impedance, Z_0 , of the system. Reactance values in the upper half of the Smith chart circle are positive (inductive) reactance, and those in the lower half of the circle are negative (capacitive) reactance. The default marker readout is in ohms (Ω) to measure resistance and reactance ($R+jX$). Additional marker types are available in the Smith marker menu.

The Smith chart is most easily understood with a full scale value of 1.0. If the scale per division is less than 0.2, the format switches automatically to polar.

If the characteristic impedance of the system is not 50 ohms, modify the impedance value recognized by the analyzer by pressing **[CAL] MORE SET Z0** (the impedance value) **[x1]**.

An inverted Smith chart format for admittance measurements (Figure 6-14) is also available. Access this by selecting **SMITH CHART** in the format menu, and pressing **[MARKER FCTN] MKR MODE MENU SMITH MKR MENU G+jB MKR**. The Smith chart is inverted and marker values are read out in siemens (S) to measure conductance and susceptance ($G+jB$).

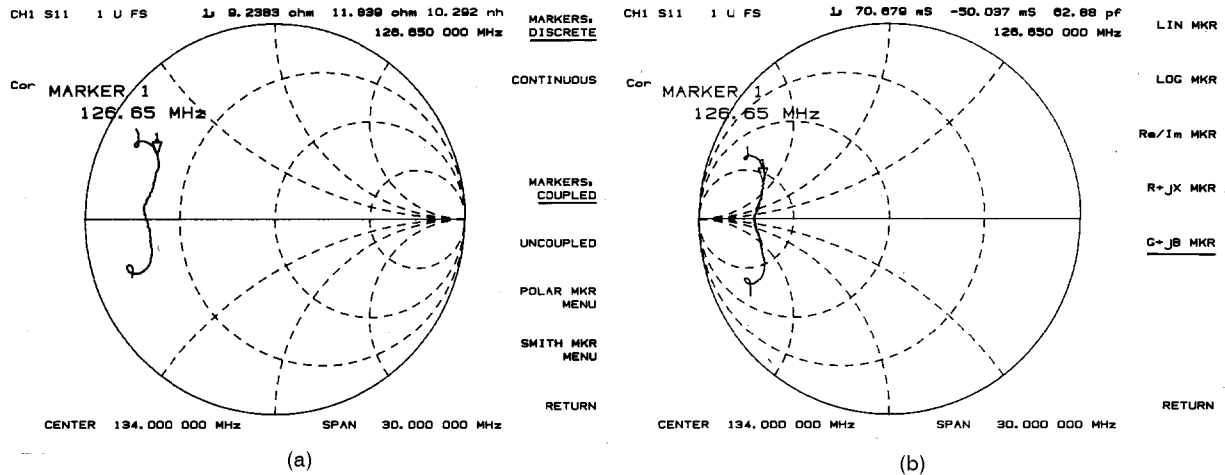

pg6176_c

Figure 6-14. Standard and Inverse Smith Chart Formats

Polar Format

The **POLAR** softkey displays a polar format (see Figure 6-15). Each point on the polar format corresponds to a particular value of both magnitude and phase. Quantities are read vectorally: the magnitude at any point is determined by its displacement from the center (which has zero value), and the phase by the angle counterclockwise from the positive x-axis. Magnitude is scaled in a linear fashion, with the value of the outer circle usually set to a ratio value of 1. Since there is no frequency axis, frequency information is read from the markers.

The default marker readout for the polar format is in linear magnitude and phase. A log magnitude marker and a real/imaginary marker are available in the polar marker menu.

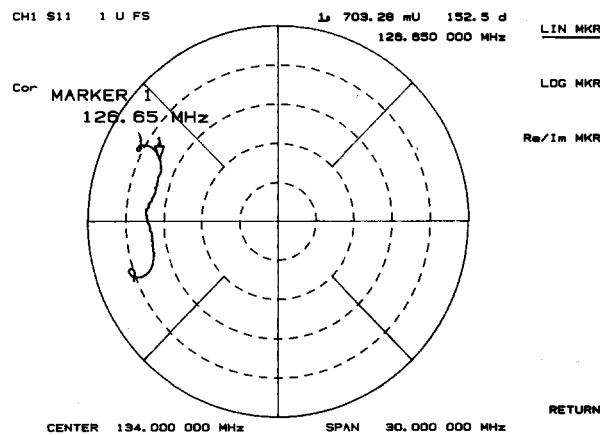

pg6177_c

Figure 6-15. Polar Format

Linear Magnitude Format

The **LIN MAG** softkey displays the linear magnitude format (see Figure 6-16). This is a Cartesian format used for unitless measurements such as reflection coefficient magnitude ρ or transmission coefficient magnitude τ , and for linear measurement units. It is used for display of conversion parameters and time domain transform data.

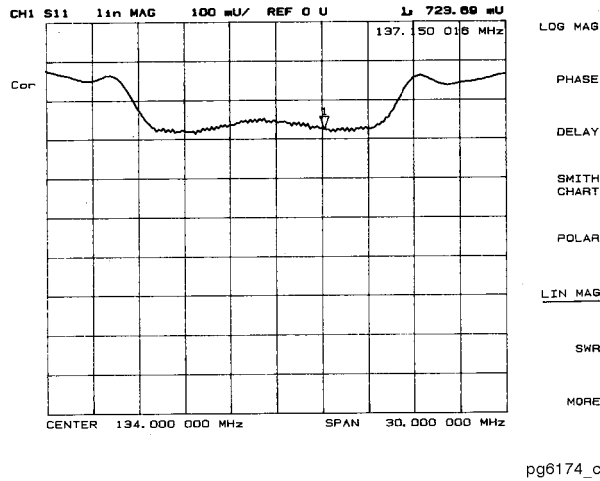

Figure 6-16. Linear Magnitude Format

SWR Format

The **SWR** softkey reformats a reflection measurement into its equivalent SWR (standing wave ratio) value (see Figure 6-17). SWR is equivalent to $(1 + \rho)/(1 - \rho)$, where ρ is the reflection coefficient. Note that the results are valid only for reflection measurements. If the SWR format is used for measurements of S_{21} or S_{12} the results are not valid.

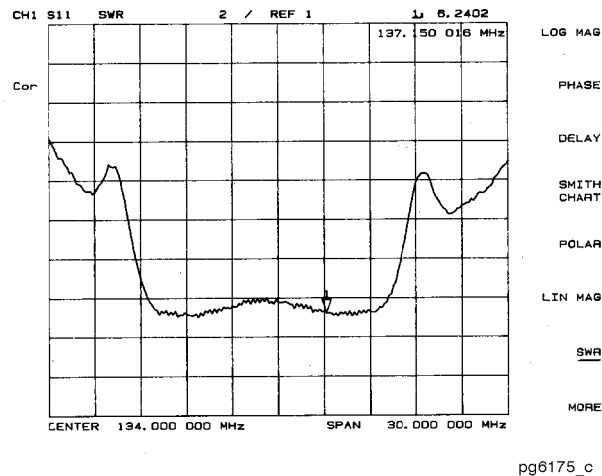
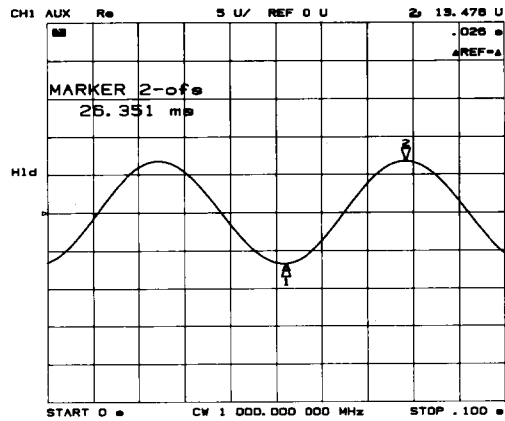

Figure 6-17. Typical SWR Display

Real Format

The **REAL** softkey displays only the real (resistive) portion of the measured data on a Cartesian format (see Figure 6-18). This is similar to the linear magnitude format, but can show both positive and negative values. It is primarily used for analyzing responses in the time domain, and also to display an auxiliary input voltage signal for service purposes.



pg6173_c

Figure 6-18. Real Format

Imaginary Format

The **IMAGINARY** softkey displays only the imaginary (reactive) portion of the measured data on a Cartesian format. This format is similar to the real format except that reactance data is displayed on the trace instead of impedance data.

Group Delay Principles

For many networks, the amount of insertion phase is not as important as the linearity of the phase shift over a range of frequencies. The analyzer can measure this linearity and express it in two different ways: directly, as deviation from linear phase, or as group delay, a derived value.

Group delay is the measurement of signal transmission time through a test device. It is defined as the derivative of the phase characteristic with respect to frequency. Since the derivative is basically the instantaneous slope (or rate of change of phase with respect to frequency), a perfectly linear phase shift results in a constant slope, and therefore a constant group delay (see Figure 6-19).

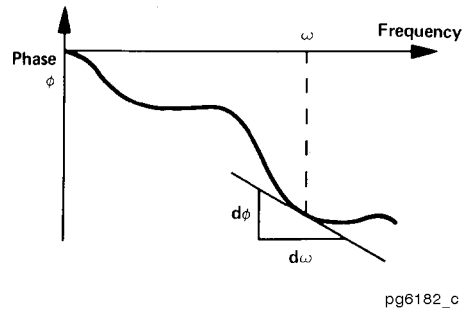
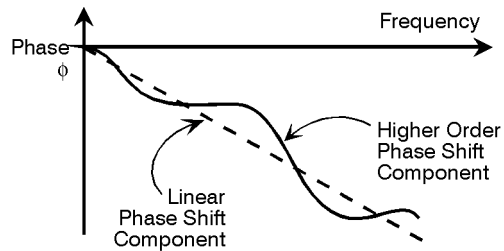

Figure 6-19. Constant Group Delay

Note, however, that the phase characteristic typically consists of both linear and higher order (deviations from linear) components. The linear component can be attributed to the electrical length of the test device, and represents the average signal transit time. The higher order components are interpreted as variations in transit time for different frequencies, and represent a source of signal distortion (see Figure 6-20).



$$\begin{aligned} \text{Group Delay} = \tau_g &= \frac{-d\phi}{d\omega} && \phi \text{ in Radians} \\ &&& \omega \text{ in Radians/Sec} \\ &= \frac{-1}{360^\circ} \cdot \frac{d\phi}{df} && \phi \text{ in Degrees} \\ &&& f \text{ in Hz } (\omega = 2\pi f) \end{aligned}$$

pb6115d

Figure 6-20. Higher Order Phase Shift

The analyzer computes group delay from the phase slope. Phase data is used to find the phase change, $\Delta\phi$, over a specified frequency aperture, Δf , to obtain an approximation for the rate of change of phase with frequency (see Figure 6-21). This value, τ_g , represents the group delay in seconds assuming linear phase change over Δf . It is important that $\Delta\phi$ be $\leq 180^\circ$, or errors will

result in the group delay data. These errors can be significant for long delay devices. You can verify that $\Delta\phi$ is $\leq 180^\circ$ by increasing the number of points or narrowing the frequency span (or both) until the group delay data no longer changes.

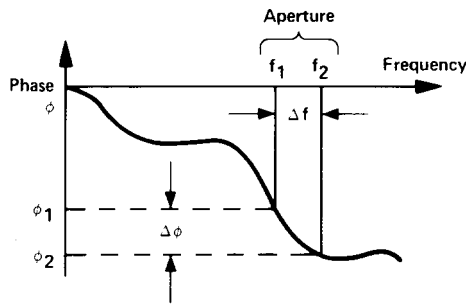

pg6180_c

Figure 6-21. Rate of Phase Change Versus Frequency

When deviations from linear phase are present, changing the frequency step can result in different values for group delay. Note that in this case the computed slope varies as the aperture Δf is increased (see Figure 6-22). A wider aperture results in loss of the fine grain variations in group delay. This loss of detail is the reason that in any comparison of group delay data, it is important to know the aperture that was used to make the measurement.

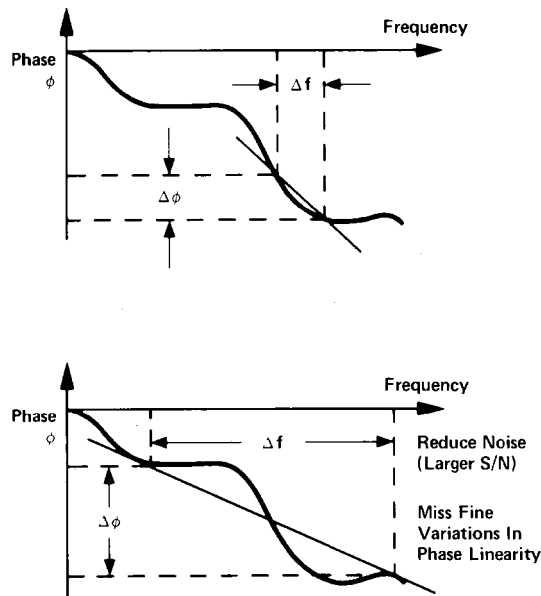

pg6181_c

Figure 6-22. Variations in Frequency Aperture

In determining the group delay aperture, there is a tradeoff between resolution of fine detail and the effects of noise. Noise can be reduced by increasing the aperture, but this will tend to smooth out the fine detail. More detail will become visible as the aperture is decreased, but the noise will also increase, possibly to the point of obscuring the detail. A good practice is to use a smaller aperture to assure that small variations are not missed, then increase the aperture to smooth the trace.

The default group delay aperture is the frequency span divided by the number of points across the display. To set the aperture to a different value, turn on smoothing in the average menu, and vary the smoothing aperture. The aperture can be varied up to 20% of the span swept.

Group delay measurements can be made on linear frequency, log frequency, or list frequency sweep types (not in CW or power sweep). Group delay aperture varies depending on the frequency spacing and point density, therefore the aperture is not constant in log and list frequency sweep modes. In list frequency mode, extra frequency points can be defined to ensure the desired aperture.

To obtain a readout of aperture values at different points on the trace, turn on a marker. Then press **AVG** **SMOOTHING APERTURE**. Smoothing aperture becomes the active function, and as the aperture is varied its value in Hz is displayed below the active entry area.

Scale Reference Menu

The **SCALE REF** key provides access to the scale reference menu. Softkeys within this menu can be used to define the scale in which measured data is to be displayed, as well as simulate phase offset and electrical delay. The following softkeys are located within the scale reference menu.

- **AUTO SCALE**
- **SCALE/DIV**
- **REFERENCE POSITION**
- **REFERENCE VALUE**
- **MARKER → REFERENCE**
- **ELECTRICAL DELAY**
- **PHASE OFFSET**
- **COAXIAL DELAY**
- **WAVEGUIDE DELAY**

Electrical Delay

The **ELECTRICAL DELAY** softkey adjusts the electrical delay to balance the phase of the test device. This softkey must be used in conjunction with **COAXIAL DELAY** or **WAVEGUIDE DELAY** (with cut-off frequency) in order to identify which type of transmission line the delay is being added to.

Electrical delay simulates a variable length lossless transmission line, which can be added to or removed from a receiver input to compensate for interconnecting cables, etc. This function is similar to the mechanical or analog “line stretchers” of other network analyzers. Delay is annotated in units of time with secondary labeling in distance for the current velocity factor.

With this feature, and with **MARKER → DELAY** (see “Using Markers”), an equivalent length of air-filled, lossless transmission line is added or subtracted according to the following formula:

$$Length (meters) = \frac{\phi}{(Freq (MHz) \times 1.20083)}$$

Once the linear portion of the test device’s phase has been removed, the equivalent length of the lossless, transmission line can be read out in the active marker area. If the average relative permittivity (ϵ_r) of the test device is known over the frequency span, the length calculation can be adjusted to indicate the actual length of the test device more closely. This can be done by entering the relative velocity factor for the test device using the calibrate more menu. The relative velocity factor for a given dielectric can be calculated by:

$$Velocity Factor = \frac{1}{\sqrt{\epsilon_r}}$$

assuming a relative permeability of 1.

Display Menu

The **DISPLAY** key provides access to the display menu, which controls the memory math functions and leads to other menus associated with display functions.

The following softkeys are located within the display menu:

- **DUAL CHAN on OFF**
- **DISPLAY: DATA**
- **DISPLAY: MEMORY**
- **DISPLAY: DATA and MEMORY**
- **DISPLAY: DATA/MEM**
- **DISPLAY: DATA - MEM**
- **DISPLAY: DATA → MEM**
- **SPLIT DISP ON off**
- **BEEP DONE ON off**
- **BEEP WARN on OFF**
- **ADJUST DISPLAY**
- **TITLE**
- **D2/D1 TO D2 on OFF**
- **FREQUENCY BLANK**

The analyzer has two available memory traces, one per channel. Memory traces are totally channel dependent: channel 1 cannot access the channel 2 memory trace or vice versa. Memory traces can be saved with instrument states: one memory trace can be saved per channel per saved instrument state. There are up to 31 save/recall registers available, so the total number of memory traces that can be present is 64 including the two active for the current instrument state. The memory data is stored as full precision, complex data.

Note You may not be able to store 31 instrument states if they include a large amount of calibration data. The calibration data contributes considerably to the size of the instrument state file and therefore the available memory may be full prior to filling all 31 registers.

Dual Channel Mode

The **DUAL CHAN ON OFF** softkey toggles between display of both measurement channels or the active channel only. This is used in conjunction with **SPLIT DISP ON off** in the display more menu to display both channels. With **SPLIT DISP ON OFF** the two traces are overlaid on a single graticule (see Figure 6-23a); with **SPLIT DISP ON off** the measurement data is displayed on two half-screen graticules one above the other (see Figure 6-23b). Current parameters for the two displays are annotated separately.

The stimulus functions of the two channels can also be controlled independently using **COUPLED CH ON off** in the stimulus menu. In addition, the markers can be controlled independently for each channel using **MARKERS: UNCOUPLED** in the marker mode menu.

Dual Channel Mode with Decoupled Channel Power

By decoupling the channel power or port power and using the dual channel mode, you can simultaneously view two measurements having different power levels. However, there are two configurations that may not appear to function “properly”.

1. Channel 1 requires one attenuation value and channel 2 requires a different value. Since one attenuator is used for both testports, this would cause the attenuator to continuously switch power ranges.
2. With Option 007 (mechanical transfer switch), channel 1 is driving one test port and channel 2 is driving the other test port. This would cause the test port transfer switch to continually cycle. The instrument will not allow the transfer switch or attenuator to continuously switch ranges in order to update these measurements without the direct intervention of the operator.

If one of the above conditions exists, the test set hold mode will engage, and the status notation **tsH** will appear on the left side of the screen. The hold mode leaves the measurement function in only one of the two measurement paths. To update both measurement setups, press **(MENU) MEASURE RESTART**. Refer to “Source Attenuator Switch Protection” earlier in this chapter for more information on this condition.

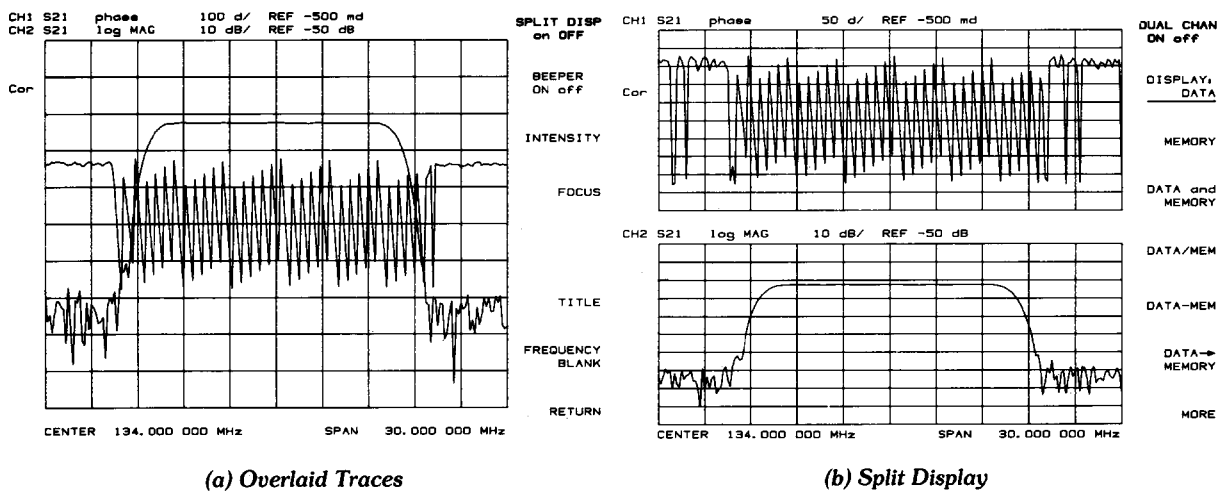

pg6172_c

Figure 6-23. Dual Channel Displays

Memory Math Functions

Two trace math operations are implemented:

- `DATA/MEM` (data/memory)
- `DATA-MEM` (data-memory)

(Note that normalization is `DATA/MEM` not `DATA-MEM`.) Memory traces are saved and recalled and trace math is done immediately after error-correction. This means that any data processing done after error-correction, including parameter conversion, time domain transformation (Option 010), scaling, etc., can be performed on the memory trace. You can also use trace math as a simple means of error-correction, although that is not its main purpose.

All data processing operations that occur after trace math, except smoothing and gating, are identical for the data trace and the memory trace. If smoothing or gating is on when a memory trace is saved, this state is maintained regardless of the data trace smoothing or gating status. If a memory trace is saved with gating or smoothing on, these features can be turned on or off in the memory-only display mode.

The actual memory for storing a memory trace is allocated only as needed. The memory trace is cleared on instrument preset, power on, or instrument state recall.

If sweep mode or sweep range is different between the data and memory traces, trace math is allowed, and no warning message is displayed. If the number of points in the two traces is different, the memory trace is not displayed nor rescaled. However, if the number of points for the data trace is changed back to the number of points in the memory, the memory trace can then be displayed.

If trace math or display memory is requested and no memory trace exists, the message **CAUTION: NO VALID MEMORY TRACE** is displayed.

Adjusting the Colors of the Display

The `ADJUST DISPLAY` softkey provides access to the adjust display menu. The following softkeys are located within this menu:

- `INTENSITY`
- `BACKGROUND INTENSITY`
- `MODIFY COLORS`
- `DEFAULT COLORS`
- `BLANK DISPLAY`
- `SAVE COLORS`
- `RECALL COLORS`

Setting Display Intensity

To adjust the intensity of the display, press `INTENSITY` and rotate the front panel knob, use the `↑` `↓` keys, or use the numerical keypad to set the intensity value between 50 and 100 percent. Lowering the intensity may prolong the life of the LCD.

Setting Default Colors

To set all the display elements to the factory-defined default colors, press **DEFAULT COLORS**.

Note **PRESET** does not reset or change colors to the default color values. However, cycling power to the instrument will reset the colors to the default color values.

Blanking the Display

Pressing **BLANK DISPLAY** switches off the analyzer display while leaving the instrument in its current measurement state. This feature may be helpful in prolonging the life of the LCD in applications where the analyzer is left unattended (such as in an automated test system). Turning the front panel knob or pressing any front panel key will restore normal display operation.

Saving Modified Colors

To save a modified color set, press **SAVE COLORS**. Modified colors are not part of a saved instrument state and are lost unless saved using these softkeys.

Recalling Modified Colors

To recall the previously saved color set, press **RECALL COLORS**.

The Modify Colors Menu

The **MODIFY COLORS** softkey within the adjust display menu provides access to the modify colors menu.

The modify colors menu allows you to adjust the colors on your analyzer's display. The default colors in this instrument have been scientifically chosen to maximize your ability to discern the difference between the colors, and to comfortably and effectively view the colors. These colors are recommended for normal use because they will provide a suitable contrast that is easy to view for long periods of time.

You may choose to change the default colors to suit environmental needs, individual preferences, or to accommodate color deficient vision. You can use any of the available colors for any of the seven display elements listed by the softkey names below:

- **CH1 DATA/LIMIT LN**
- **CH1 MEM**
- **CH2 DATA/LIMIT LN**
- **CH2 MEM/REF LINE**
- **GRATICULE/TEXT**
- **WARNING**
- **TEXT**

To change the color of a display elements, press the softkey for that element (such as **CH1 DATA**). Then press **TINT** and turn the analyzer front panel knob, use the step keys or the numeric keypad, until the desired color appears.

Note Maximum viewing angle with the LCD display is achieved when primary colors or a combination of them are selected at full brightness (100%). The following table lists the recommended colors and their corresponding tint numbers.

Table 6-2. Display Colors with Maximum Viewing Angle

Display Color	Tint	Brightness	Color
Red	0	100	100
Yellow	17	100	100
Green	33	100	100
Cyan	50	100	100
Blue	67	100	100
Magenta	83	100	100
White		100	0

Color is comprised of three parameters:

Tint: The continuum of hues on the color wheel, ranging from red, through green and blue, and back to red.

Brightness: A measure of the brightness of the color.

Color: The degree of whiteness of the color. A scale from white to pure color.

The most frequently occurring color deficiency is the inability to distinguish red, yellow, and green from one another. Confusion between these colors can usually be eliminated by increasing the brightness between the colors. To accomplish this, press the **BRIGHTNESS** softkey and turn the analyzer front panel knob. If additional adjustment is needed, vary the degree of whiteness of the color. To accomplish this, press the **COLOR** softkey and turn the analyzer front panel knob.

Note Color changes and adjustments remain in effect until changed again in these menus or the analyzer is powered off and then on again. Cycling the power changes all color adjustments to default values. Preset does not affect color selection.

Averaging Menu

The **[AVG]** key is used to access three different noise reduction techniques: sweep-to-sweep averaging, display smoothing, and variable IF bandwidth. All of these can be used simultaneously. Averaging and smoothing can be set independently for each channel, and the IF bandwidth can be set independently if the stimulus is uncoupled.

The following softkeys are located within the averaging menu:

- AVERAGING RESTART
- AVERAGING FACTOR
- AVERAGING ON off
- SMOOTHING APERTURE
- SMOOTHING ON off
- IF BW []

Averaging

Averaging computes each data point based on an exponential average of consecutive sweeps weighted by a user-specified averaging factor. Each new sweep is averaged into the trace until the total number of sweeps is equal to the averaging factor, for a fully averaged trace. Each point on the trace is the vector sum of the current trace data and the data from the previous sweep. A high averaging factor gives the best signal-to-noise ratio, but slows the trace update time. Doubling the averaging factor reduces the noise by 3 dB. Averaging is used for ratioed measurements: if it is attempted for a single-input measurement (e.g. A or B), the message CAUTION: AVERAGING INVALID ON NON-RATIO MEASURE is displayed. Figure 6-24 illustrates the effect of averaging on a log magnitude format trace.

Note If you switch power ranges with averaging on, the average will restart.

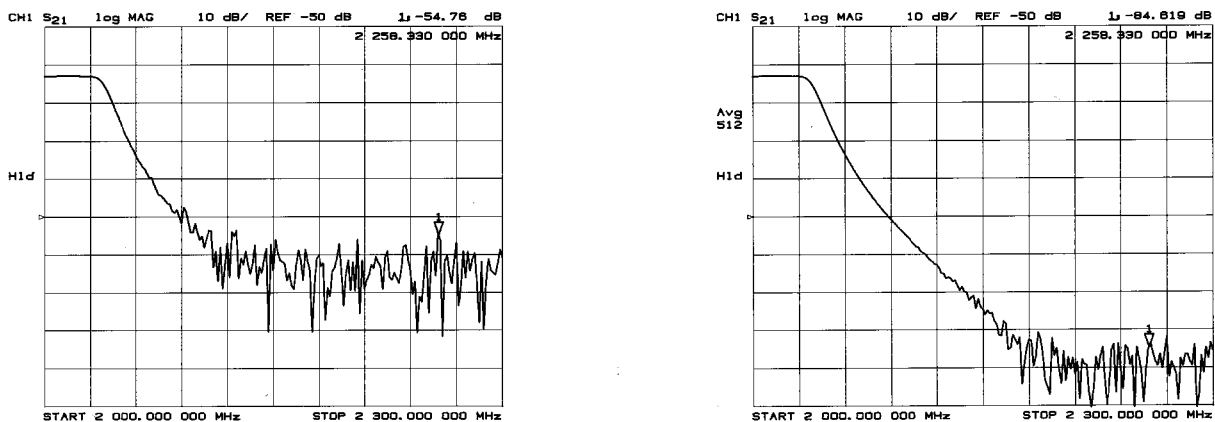

pg6171_c

Figure 6-24. Effect of Averaging on a Trace

Smoothing

Smoothing (similar to video filtering) averages the formatted active channel data over a portion of the displayed trace. Smoothing computes each displayed data point based on one sweep only, using a moving average of several adjacent data points for the current sweep. The smoothing aperture is a percent of the swept stimulus span, up to a maximum of 20%.

Rather than lowering the noise floor, smoothing finds the mid-value of the data. Use it to reduce relatively small peak-to-peak noise values on broadband measured data. Use a sufficiently high number of display points to avoid misleading results. Do not use smoothing for measurements of high resonance devices or other devices with wide trace variations, as it will introduce errors into the measurement.

Smoothing is used with Cartesian and polar display formats. It is also the primary way to control the group delay aperture, given a fixed frequency span. (Refer to “Group Delay Principles” earlier in this section.) In polar display format, large phase shifts over the smoothing aperture will cause shifts in amplitude, since a vector average is being computed. Figure 6-25 illustrates the effect of smoothing on a log magnitude format trace.

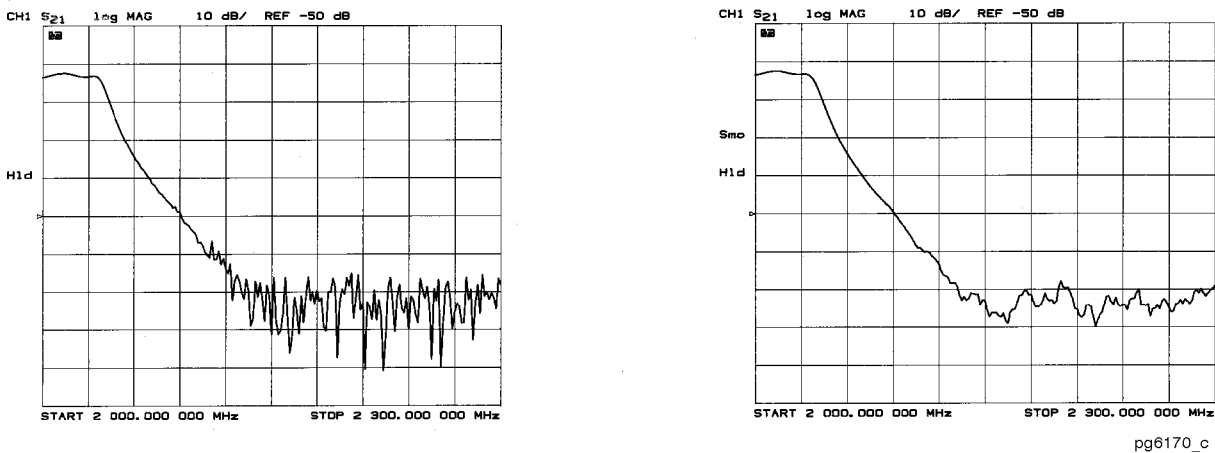
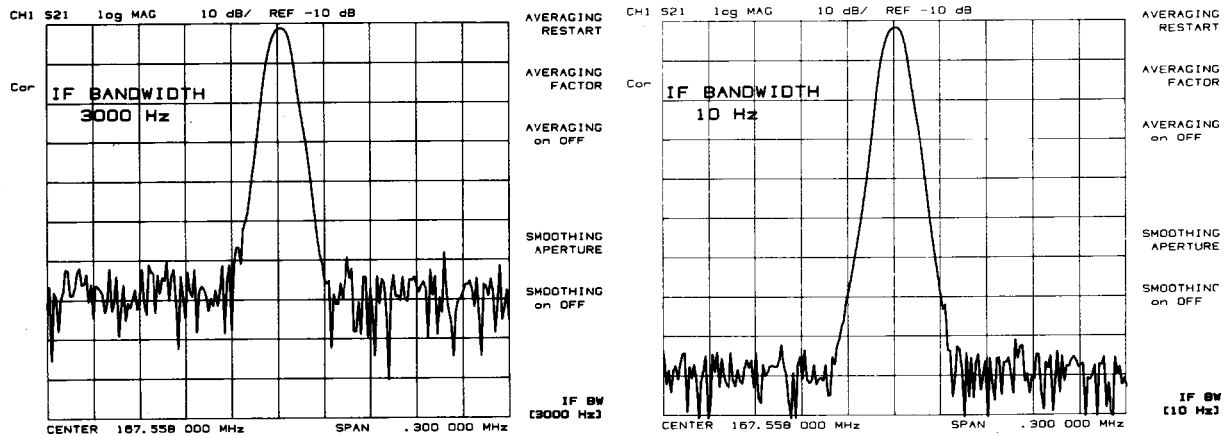

Figure 6-25. Effect of Smoothing on a Trace

IF Bandwidth Reduction

IF bandwidth reduction lowers the noise floor by digitally reducing the receiver input bandwidth. It works in all ratio and non-ratio modes. It has an advantage over averaging as it reliably filters out unwanted responses such as spurs, odd harmonics, higher frequency spectral noise, and line-related noise. Sweep-to-sweep averaging, however, is better at filtering out very low frequency noise. A tenfold reduction in IF bandwidth lowers the measurement noise floor by about 10 dB. Bandwidths less than 300 Hz provide better harmonic rejection than higher bandwidths.

Another difference between sweep-to-sweep averaging and variable IF bandwidth is the sweep time. Averaging displays the first complete trace faster but takes several sweeps to reach a fully averaged trace. IF bandwidth reduction lowers the noise floor in one sweep, but the sweep time may be slower. Figure 6-26 illustrates the difference in noise floor between a trace measured with a 3000 Hz IF bandwidth and with a 10 Hz IF bandwidth.



pg6168_c

Figure 6-26. IF Bandwidth Reduction

Hints

Another capability that can be used for effective noise reduction is the marker statistics function, which computes the average value of part or all of the formatted trace.

If your instrument is equipped with Option 085 (High Power System), another way of increasing dynamic range is to increase the input power to the test device using a booster amplifier.

Markers

The **MARKER** key displays a movable active marker on the screen and provides access to a series of menus to control up to five display markers for each channel. Markers are used to obtain numerical readings of measured values. They also provide capabilities for reducing measurement time by changing stimulus parameters, searching the trace for specific values, or statistically analyzing part or all of the trace. Figure 6-27 illustrates the displayed trace with all markers on and marker 2 the active marker.

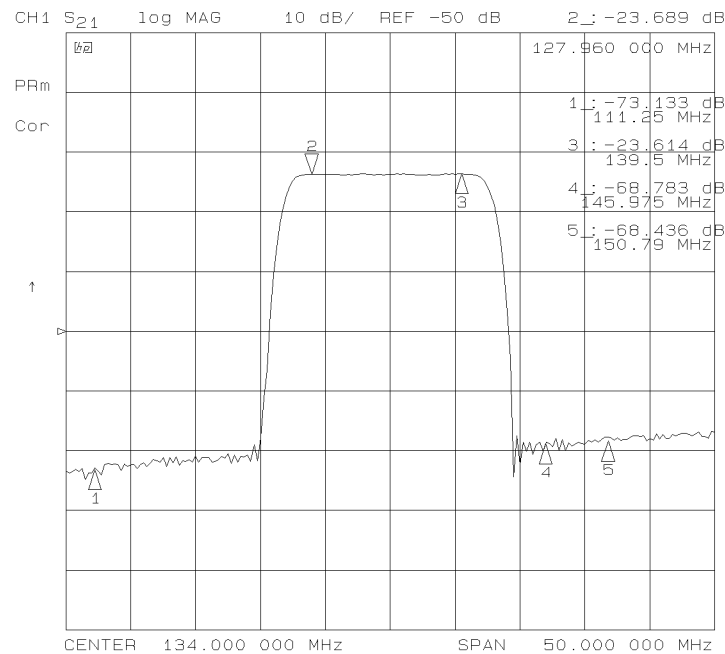

Figure 6-27. Markers on Trace

Markers have a stimulus value (the x-axis value in a Cartesian format) and a response value (the y-axis value in a Cartesian format). In a polar or Smith chart format, the second part of a complex data pair is also provided as an auxiliary response value. When a marker is activated and no other function is active, its stimulus value is displayed in the active entry area and can be controlled with the knob, the step keys, or the numeric keypad. The active marker can be moved to any point on the trace, and its response and stimulus values are displayed at the top right corner of the graticule for each displayed channel, in units appropriate to the display format. The displayed marker response values are valid even when the measured data is above or below the range displayed on the graticule.

Marker values are normally continuous: that is, they are interpolated between measured points. Or, they can be set to read only discrete measured points. The markers for the two channels normally have the same stimulus values, or they can be uncoupled so that each channel has independent markers, regardless of whether stimulus values are coupled or dual channel display is on.

If both data and memory are displayed, the marker values apply to the data trace. If only memory is displayed, the marker values apply to the memory trace. In a memory math display (data/memory or data–memory), the marker values apply to the trace resulting from the memory math function.

With the use of a reference marker, a delta marker mode is available that displays both the stimulus and response values of the active marker relative to the reference. Any of the five markers or a fixed point can be designated as the delta reference marker. If the delta reference is one of the five markers, its stimulus value can be controlled by the user and its response value is the value of the trace at that stimulus value. If the delta reference is a fixed marker, both its stimulus value and its response value can be set arbitrarily anywhere in the display area (not necessarily on the trace).

Markers can be used to search for the trace maximum or minimum point or any other point on the trace. The five markers can be used together to search for specified bandwidth cutoff points and calculate the bandwidth and Q values. Statistical analysis uses markers to provide a readout of the mean, standard deviation, and peak-to-peak values of all or part of the trace.

Basic marker operations are available in the menus accessed from the **MARKER** key. The marker search and statistical functions, together with the capability for quickly changing stimulus parameters with markers, are provided in the menus accessed from the **MARKER FCTN** key.

Marker Menu

The **MARKER** key provides access to the marker menu. This menu allows you to turn the display markers on or off, to designate the active marker, and to gain access to the delta marker menu and the fixed marker menu.

Delta Mode Menu

The **Δ MODE MENU** softkey within the marker menu provides access to the delta mode menu. The delta reference is shown on the display as a small triangle Δ, smaller than the inactive marker triangles. If one of the markers is the reference, the triangle appears next to the marker number on the trace.

The marker values displayed in this mode are the stimulus and response values of the active marker minus the reference marker. If the active marker is also designated as the reference marker, the marker values are zero.

Fixed Marker Menu. The **FIXED MKR POSTION** softkey within the delta mode menu provides access to the fixed marker menu. This menu is used to set the position of a fixed reference marker, indicated on the display by a small triangle Δ. Both the stimulus value and the response value of the fixed marker can be set arbitrarily anywhere in the display area, and need not be on the trace. The units are determined by the display format, the sweep type, and the marker type.

There are two ways to turn on the fixed marker. One way is with the **Δ REF = Δ FIXED MKR** softkey in the delta marker menu. The other is with the **MKR ZERO** function in the marker menu, which puts a fixed reference marker at the present active marker position and makes the marker stimulus and response values at that position equal to zero.

The softkeys in this menu make the values of the fixed marker the active function. The marker readings in the top right corner of the graticule are the stimulus and response values of the active marker minus the fixed reference marker. Also displayed in the top right corner is the notation $\Delta\text{REF}=\Delta$.

The stimulus value, response value, and auxiliary response value (the second part of a complex data pair) can be individually examined and changed. This allows active marker readings that are relative in amplitude yet absolute in frequency, or any combination of relative/absolute readouts. Following a **MKR ZERO** operation, this menu can be used to reset any of the fixed marker values to absolute zero for absolute readings of the subsequent active marker values.

If the format is changed while a fixed marker is on, the fixed marker values become invalid. For example, if the value offset is set to 10 dB with a log magnitude format, and the format is then changed to phase, the value offset becomes 10 degrees. However, in polar and Smith chart formats, the specified values remain consistent between different marker types for those formats. Thus an R+jX marker set on a Smith chart format will retain the equivalent values if it is changed to any of the other Smith chart markers.

Marker Function Menu

The **MARKER FCTN** key provides access to the marker function menu. This menu provides softkeys that use markers to quickly modify certain measurement parameters without going through the usual key sequence. In addition, it provides access to two additional menus used for searching the trace and for statistical analysis.

The **MARKER** — functions change certain stimulus and response parameters to make them equal to the current active marker value. Use the knob or the numeric keypad to move the marker to the desired position on the trace, and press the appropriate softkey to set the specified parameter to that trace value. When the values have been changed, the marker can again be moved within the range of the new parameters.

Marker Search Menu

The **MKR SEARCH** [] softkey within the marker function menu provides access to the marker search menu. This menu is used to search the trace for a specific amplitude-related point, and place the marker on that point. The capability of searching for a specified bandwidth is also provided. Tracking is available for a continuous sweep-to-sweep search. If there is no occurrence of a specified value or bandwidth, the message **TARGET VALUE NOT FOUND** is displayed.

Target Menu. The **TARGET** softkey within the marker search menu provides access to the target menu. This menu lets you place the marker at a specified target response value on the trace, and provides search right and search left options. If there is no occurrence of the specified value, the message **TARGET VALUE NOT FOUND** is displayed.

Marker Mode Menu

The **MKR MODE MENU** softkey within the marker function menu provides access to the marker mode menu. This menu provides different marker modes and leads to the following two menus:

Polar Marker Menu. This menu is used only with a polar display format, selectable using the **FORMAT** key. In a polar format, the magnitude at the center of the circle is zero and the outer circle is the full scale value set in the scale reference menu. Phase is measured as the angle counterclockwise from 0° at the positive x-axis. The analyzer automatically calculates different mathematical forms of the marker magnitude and phase values, selected using the softkeys in this menu. Marker frequency is displayed in addition to other values regardless of the selection of marker type.

Smith Marker Menu. This menu is used only with a Smith chart format, selected from the format menu. The analyzer automatically calculates different mathematical forms of the marker magnitude and phase values, selected using the softkeys in this menu. Marker frequency is displayed in addition to other values for all marker types.

Measurement Calibration

Measurement calibration is an accuracy enhancement procedure that effectively removes the system errors that cause uncertainty in measuring a test device. It measures known standard devices, and uses the results of these measurements to characterize the system.

This section discusses the following topics:

- definition of accuracy enhancement
- causes of measurement errors
- characterization of microwave systematic errors
- calibration considerations
- effectiveness of accuracy enhancement
- correcting for measurement errors
- ensuring a valid calibration
- modifying calibration kits
- TRL*/LRM* calibration
- power meter calibration
- calibrating for non-insertable devices

What is Accuracy Enhancement?

A perfect measurement system would have infinite dynamic range, isolation, and directivity characteristics, no impedance mismatches in any part of the test setup, and flat frequency response. In any high frequency measurement there are measurement errors associated with the system that contribute uncertainty to the results. Parts of the measurement setup such as interconnecting cables and signal-separation devices (as well as the analyzer itself) all introduce variations in magnitude and phase that can mask the actual performance of the test device. Vector accuracy enhancement, also known as measurement calibration or error-correction, provides the means to simulate a nearly perfect measurement system.

For example, crosstalk due to the channel isolation characteristics of the analyzer can contribute an error equal to the transmission signal of a high-loss test device. For reflection measurements, the primary limitation of dynamic range is the directivity of the test setup. The measurement system cannot distinguish the true value of the signal reflected by the test device from the signal arriving at the receiver input due to leakage in the system. For both transmission and reflection measurements, impedance mismatches within the test setup cause measurement uncertainties that appear as ripples superimposed on the measured data.

Error-correction simulates an improved analyzer system. During the measurement calibration process, the analyzer measures the magnitude and phase responses of known standard devices, and compares the measurement with actual device data. The analyzer uses the results to characterize the system and effectively remove the system errors from the measurement data of a test device, using vector math capabilities internal to the network analyzer.

When you use a measurement calibration, the dynamic range and accuracy of the measurement are limited only by system noise and stability, connector repeatability, and the accuracy to which the characteristics of the calibration standards are known.

What Causes Measurement Errors?

Network analysis measurement errors can be separated into systematic, random, and drift errors.

Correctable systematic errors are the repeatable errors that the system can measure. These are errors due to mismatch and leakage in the test setup, isolation between the reference and test signal paths, and system frequency response.

The system cannot measure and correct for the non-repeatable random and drift errors. These errors affect both reflection and transmission measurements. Random errors are measurement variations due to noise and connector repeatability. Drift errors include frequency drift, temperature drift, and other physical changes in the test setup between calibration and measurement.

The resulting measurement is the vector sum of the test device response plus all error terms. The precise effect of each error term depends upon its magnitude and phase relationship to the actual test device response.

In most high frequency measurements the systematic errors are the most significant source of measurement uncertainty. Since each of these errors can be characterized, their effects can be effectively removed to obtain a corrected value for the test device response. For the purpose of vector accuracy enhancement these uncertainties are quantified as directivity, source match, load match, isolation (crosstalk), and frequency response (tracking). Each of these systematic errors is described below.

Random and drift errors cannot be precisely quantified, so they must be treated as producing a cumulative uncertainty in the measured data.

Directivity

Normally a device that can separate the reverse from the forward traveling waves (a directional bridge or coupler) is used to detect the signal reflected from the test device. Ideally the coupler would completely separate the incident and reflected signals, and only the reflected signal would appear at the coupled output, as illustrated in Figure 6-28a.

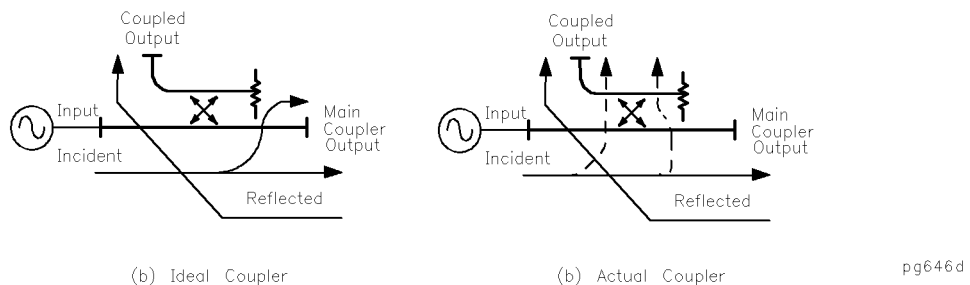
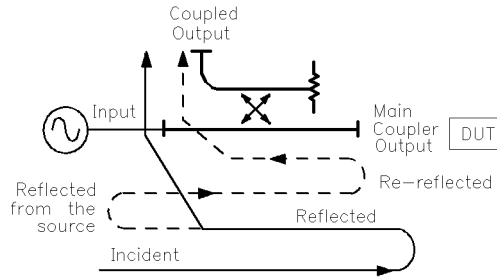

Figure 6-28. Directivity

However, an actual coupler is not perfect, as illustrated in Figure 6-28b. A small amount of the incident signal appears at the coupled output due to leakage as well as reflection from the termination in the coupled arm. Also, reflections from the coupler output connector appear at the coupled output, adding uncertainty to the signal reflected from the device. The figure of merit for how well a coupler separates forward and reverse waves is directivity. The greater the directivity of the device, the better the signal separation. System directivity is the vector sum of all leakage signals appearing at the analyzer receiver input. The error contributed by directivity is independent of the characteristics of the test device and it usually produces the major ambiguity in measurements of low reflection devices.

Source Match

Source match is defined as the vector sum of signals appearing at the analyzer receiver input due to the impedance mismatch at the test device looking back into the source, as well as to adapter and cable mismatches and losses. In a reflection measurement, the source match error signal is caused by some of the reflected signal from the test device being reflected from the source back toward the test device and re-reflected from the test device (Figure 6-29). In a transmission measurement, the source match error signal is caused by reflection from the test device that is re-reflected from the source. Source match is most often given in terms of return loss in dB; thus the larger the number, the smaller the error.



pg647d

Figure 6-29. Source Match

The error contributed by source match is dependent on the relationship between the actual input impedance of the test device and the equivalent match of the source. It is a factor in both transmission and reflection measurements. Source match is a particular problem in measurements where there is a large impedance mismatch at the measurement plane. (For example, reflection devices such as filters with stop bands.)

Load Match

Load match error results from an imperfect match at the output of the test device. It is caused by impedance mismatches between the test device output port and port 2 of the measurement system. As illustrated in Figure 6-30, some of the transmitted signal is reflected from port 2 back to the test device. A portion of this wave may be re-reflected to port 2, or part may be transmitted through the device in the reverse direction to appear at port 1. If the test device has low insertion loss (for example a filter pass band), the signal reflected from port 2 and re-reflected from the source causes a significant error because the test device does not attenuate the signal significantly on each reflection. Load match is usually given in terms of return loss in dB; thus the larger the number, the smaller the error.

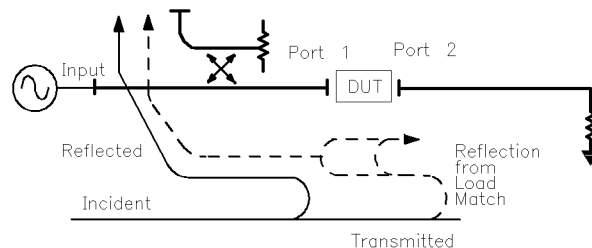

pb6114d

Figure 6-30. Load Match

The error contributed by load match is dependent on the relationship between the actual output impedance of the test device and the effective match of the return port (port 2). It is a factor in all transmission measurements and in reflection measurements of two-port devices. The interaction between load match and source match is less significant when the test device insertion loss is greater than about 6 dB. However, source match and load match still interact with the input and output matches of the DUT, which contributes to transmission measurement errors. (These errors are largest for devices with highly reflective output ports.)

Isolation (Crosstalk)

Leakage of energy between analyzer signal paths contributes to error in a transmission measurement, much like directivity does in a reflection measurement. Isolation is the vector sum of signals appearing at the analyzer samplers due to crosstalk between the reference and test signal paths. This includes signal leakage within the test set and in both the RF and IF sections of the receiver.

The error contributed by isolation depends on the characteristics of the test device. Isolation is a factor in high-loss transmission measurements. However, analyzer system isolation is more than sufficient for most measurements, and correction for it may be unnecessary.

For measuring devices with high dynamic range, accuracy enhancement can provide improvements in isolation that are limited only by the noise floor. Generally, the isolation falls below the noise floor, therefore, when performing an isolation calibration you should use a noise reduction function such as averaging or reduce the IF bandwidth.

Frequency Response (Tracking)

This is the vector sum of all test setup variations in which magnitude and phase change as a function of frequency. This includes variations contributed by signal-separation devices, test cables, adapters, and variations between the reference and test signal paths. This error is a factor in both transmission and reflection measurements.

For further explanation of systematic error terms and the way they are combined and represented graphically in error models, refer to the “Characterizing Microwave Systematic Errors” next.

Characterizing Microwave Systematic Errors

One-Port Error Model

In a measurement of the reflection coefficient (magnitude and phase) of a test device, the measured data differs from the actual, no matter how carefully the measurement is made. Directivity, source match, and reflection signal path frequency response (tracking) are the major sources of error (see Figure 6-31).

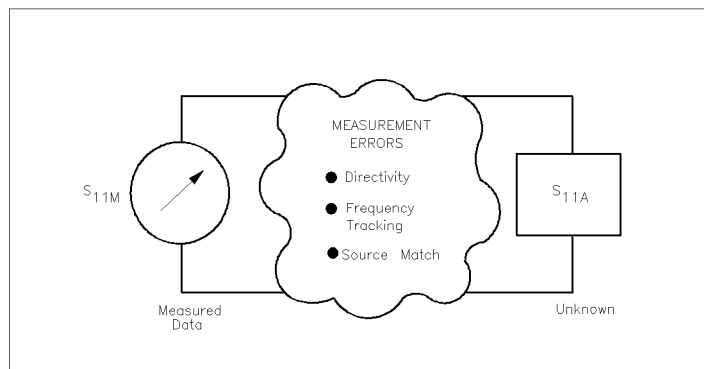

pg649d

Figure 6-31. Sources of Error in a Reflection Measurement

To characterize the errors, the reflection coefficient is measured by first separating the incident signal (I) from the reflected signal (R), then taking the ratio of the two values (see Figure 6-32). Ideally, (R) consists only of the signal reflected by the test device (S_{11A} , for S_{11} actual).

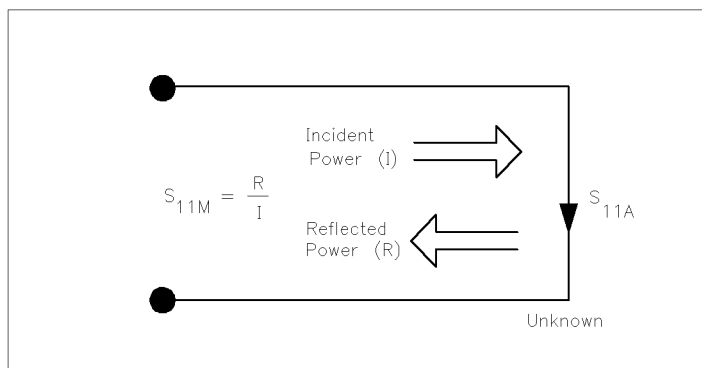

pg650d

Figure 6-32. Reflection Coefficient

However, all of the incident signal does not always reach the unknown (see Figure 6-33). Some of (I) may appear at the measurement system input due to leakage through the test set or through a signal separation device. Also, some of (I) may be reflected by imperfect adapters between a signal separation device and the measurement plane. The vector sum of the leakage and the miscellaneous reflections is the effective directivity, E_{DF} . Understandably, the measurement is distorted when the directivity signal combines vectorally with the actual reflected signal from the unknown, S_{11A} .

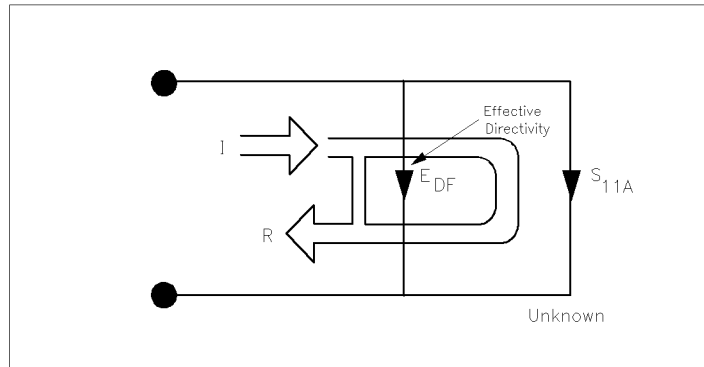

pg651d

Figure 6-33. Effective Directivity E_{DF}

Since the measurement system test port is never exactly the characteristic impedance (50 ohms), some of the reflected signal bounces off the test port, or other impedance transitions further down the line, and back to the unknown, adding to the original incident signal (I). This effect causes the magnitude and phase of the incident signal to vary as a function of S_{11A} and frequency. Leveling the source to produce a constant incident signal (I) reduces this error, but since the source cannot be exactly leveled at the test device input, leveling cannot eliminate all power variations. This re-reflection effect and the resultant incident power variation are caused by the source match error, E_{SF} (see Figure 6-34).

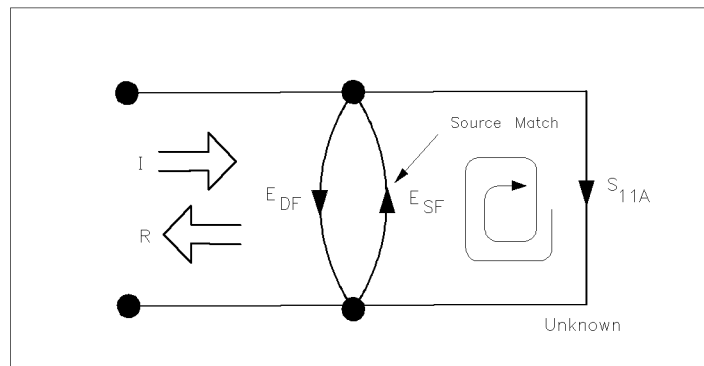

pg652d

Figure 6-34. Source Match E_{SF}

Frequency response (tracking) error is caused by variations in magnitude and phase flatness versus frequency between the test and reference signal paths. These are due mainly to coupler roll off, imperfectly matched samplers, and differences in length and loss between the incident and test signal paths. The vector sum of these variations is the reflection signal path tracking error, E_{RF} (see Figure 6-35).

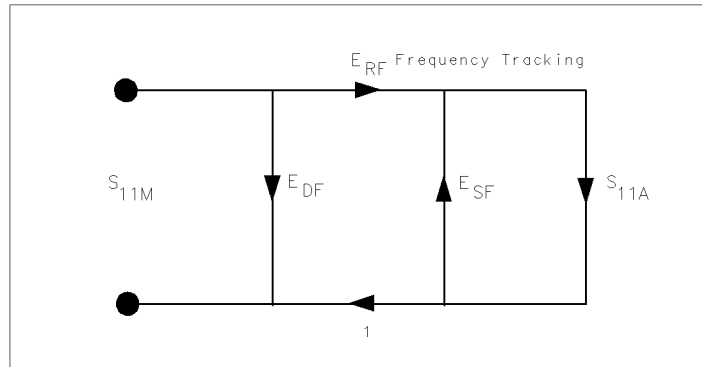

pg653d

Figure 6-35. Reflection Tracking E_{RF}

These three errors are mathematically related to the actual data, S_{11A} , and measured data, S_{11M} , by the following equation:

$$S_{11M} = E_{DF} + \frac{(S_{11A}E_{RF})}{(1 - E_{SF}S_{11A})}$$

If the value of these three “E” errors and the measured test device response were known for each frequency, the above equation could be solved for S_{11A} to obtain the actual test device response. Because each of these errors changes with frequency, their values must be known at each test frequency. These values are found by measuring the system at the measurement plane using three independent standards whose S_{11A} is known at all frequencies.

The first standard applied is a “perfect load,” which makes $S_{11A} = 0$ and essentially measures directivity (see Figure 6-36). “Perfect load” implies a reflectionless termination at the measurement plane. All incident energy is absorbed. With $S_{11A} = 0$ the equation can be solved for E_{DF} , the directivity term. In practice, of course, the “perfect load” is difficult to achieve, although very good broadband loads are available in the HP 8753D compatible calibration kits.

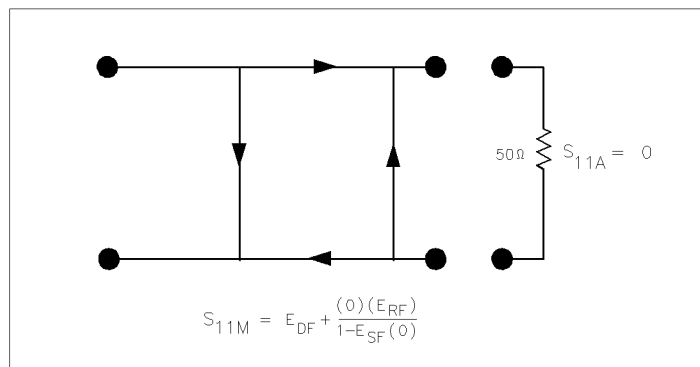

pg654d

Figure 6-36. “Perfect Load” Termination

Since the measured value for directivity is the vector sum of the actual directivity plus the actual reflection coefficient of the “perfect load,” any reflection from the termination represents an error. System effective directivity becomes the actual reflection coefficient of the near “perfect load” (see Figure 6-37). In general, any termination having a return loss value greater than the uncorrected system directivity reduces reflection measurement uncertainty.

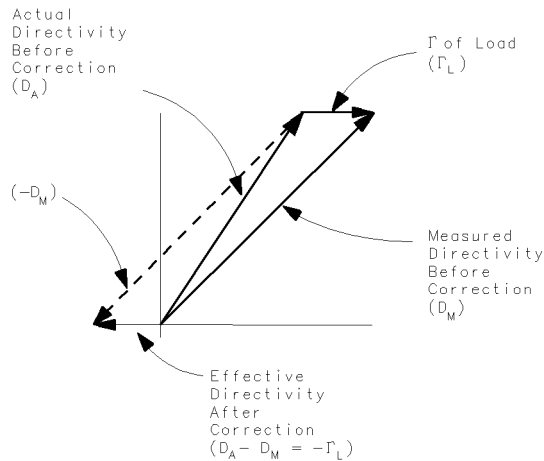

pb6112d

Figure 6-37. Measured Effective Directivity

Next, a short circuit termination whose response is known to a very high degree is used to establish another condition (see Figure 6-38).

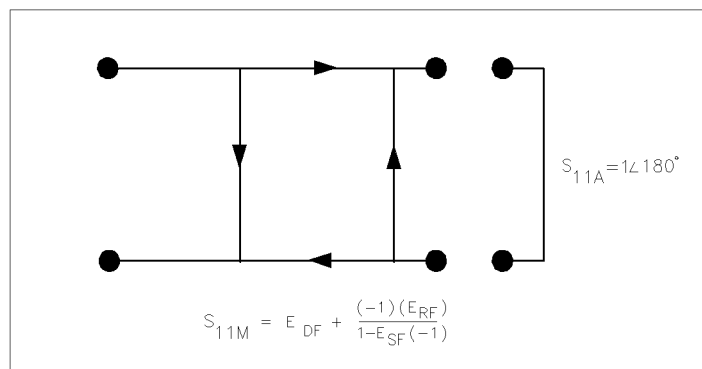

pg656d

Figure 6-38. Short Circuit Termination

The open circuit gives the third independent condition. In order to accurately model the phase variation with frequency due to fringing capacitance from the open connector, a specially designed shielded open circuit is used for this step. (The open circuit capacitance is different with each connector type.) Now the values for E_{DF} , directivity, E_{SF} , source match, and E_{RF} , reflection frequency response, are computed and stored (see Figure 6-39).

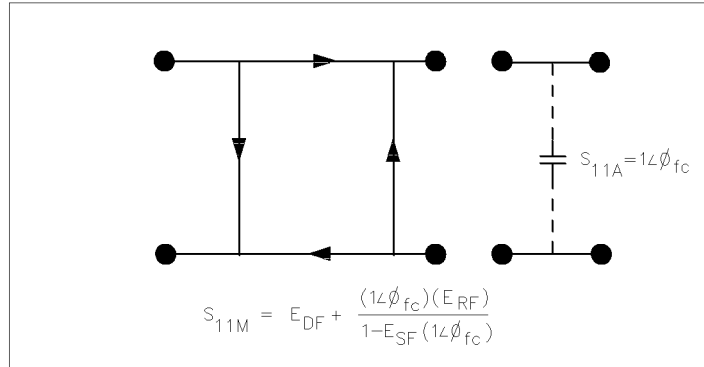

pb6113d

Figure 6-39. Open Circuit Termination

This completes the calibration procedure.

Device Measurement

Now the unknown is measured to obtain a value for the measured response, S_{11M} , at each frequency (see Figure 6-40).

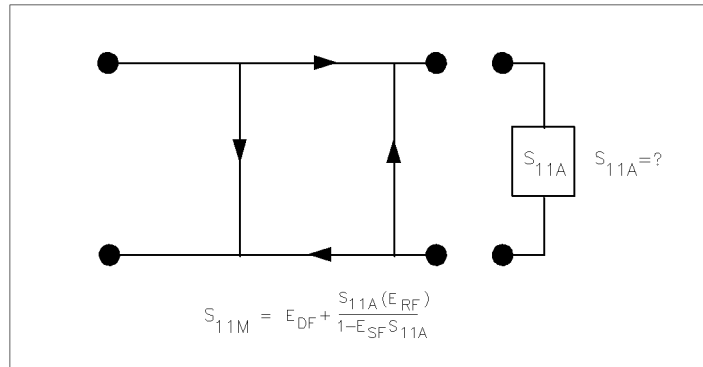

pg658d

Figure 6-40. Measured S_{11}

This is the one-port error model equation solved for S_{11A} . Since the three errors and S_{11M} are now known for each test frequency, S_{11A} can be computed as follows:

$$S_{11A} = S_{11M} - \frac{E_{DF}}{E_{SF}(S_{11M} - E_{DF}) + E_{RF}}$$

For reflection measurements on two-port devices, the same technique can be applied, but the test device output port must be terminated in the system characteristic impedance. This termination should have as low a reflection coefficient as the load used to determine directivity. The additional reflection error caused by an improper termination at the test device's output port is not incorporated into the one-port error model.

Two-Port Error Model

The error model for measurement of the transmission coefficients (magnitude and phase) of a two-port device is derived in a similar manner. The potential sources of error are frequency response (tracking), source match, load match, and isolation (see Figure 6-41). These errors are effectively removed using the full two-port error model.

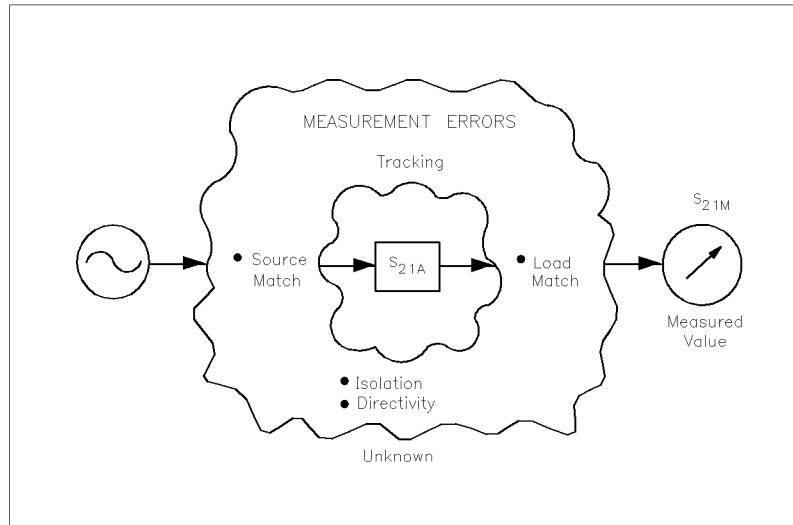

pg659d

Figure 6-41. Major Sources of Error

The transmission coefficient is measured by taking the ratio of the incident signal (I) and the transmitted signal (T) (see Figure 6-42). Ideally, (I) consists only of power delivered by the source, and (T) consists only of power emerging at the test device output.

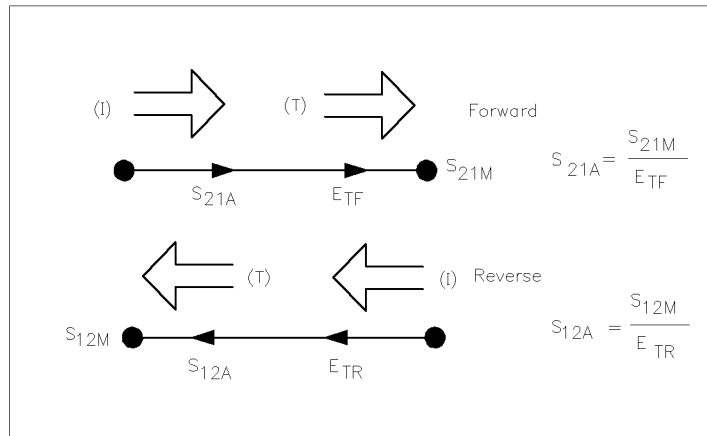

pg660d

Figure 6-42. Transmission Coefficient

As in the reflection model, source match can cause the incident signal to vary as a function of test device S_{11A} . Also, since the test setup transmission return port is never exactly the characteristic impedance, some of the transmitted signal is reflected from the test set port 2, and from other mismatches between the test device output and the receiver input, to return to the test device. A portion of this signal may be re-reflected at port 2, thus affecting S_{21M} , or part may be transmitted through the device in the reverse direction to appear at port 1, thus affecting S_{11M} . This error term, which causes the magnitude and phase of the transmitted signal to vary as a function of S_{22A} , is called load match, E_{LF} (see Figure 6-43).

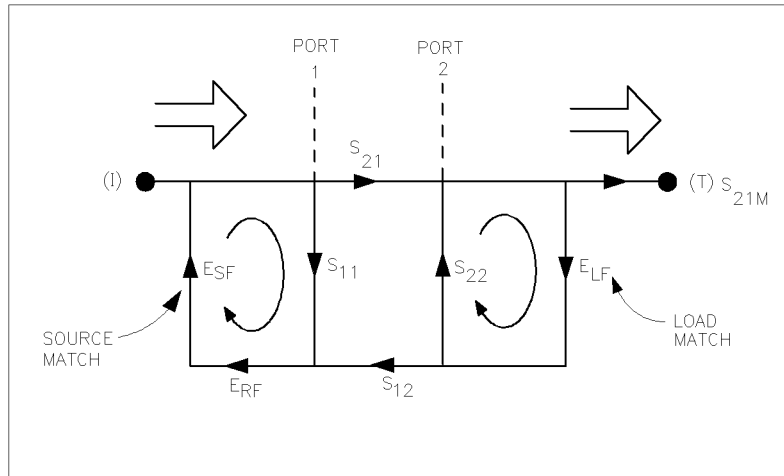

pg661d

Figure 6-43. Load Match E_{LF}

The measured value, S_{21M} , consists of signal components that vary as a function of the relationship between E_{SF} and S_{11A} as well as E_{LF} and S_{22A} , so the input and output reflection coefficients of the test device must be measured and stored for use in the S_{21A} error-correction computation. Thus, the test setup is calibrated as described above for reflection to establish the directivity, E_{DF} , source match, E_{SF} , and reflection frequency response, E_{RF} , terms for the reflection measurements.

Now that a calibrated port is available for reflection measurements, the thru is connected and load match, E_{LF} , is determined by measuring the reflection coefficient of the thru connection.

Transmission signal path frequency response is then measured with the thru connected. The data is corrected for source and load match effects, then stored as transmission frequency response, E_{TF} .

Note It is very important that the exact electrical length of the thru be known. Most calibration kits assume a zero length thru. For some connection types such as Type-N, this implies one male and one female port. If the test system requires a non-zero length thru, for example, one with two male test ports, the exact electrical delay of the thru adapter must be used to modify the built-in calibration kit definition of the thru.

Isolation, E_{XF} , represents the part of the incident signal that appears at the receiver without actually passing through the test device (see Figure 6-44). Isolation is measured with the test set in the transmission configuration and with terminations installed at the points where the test device will be connected.

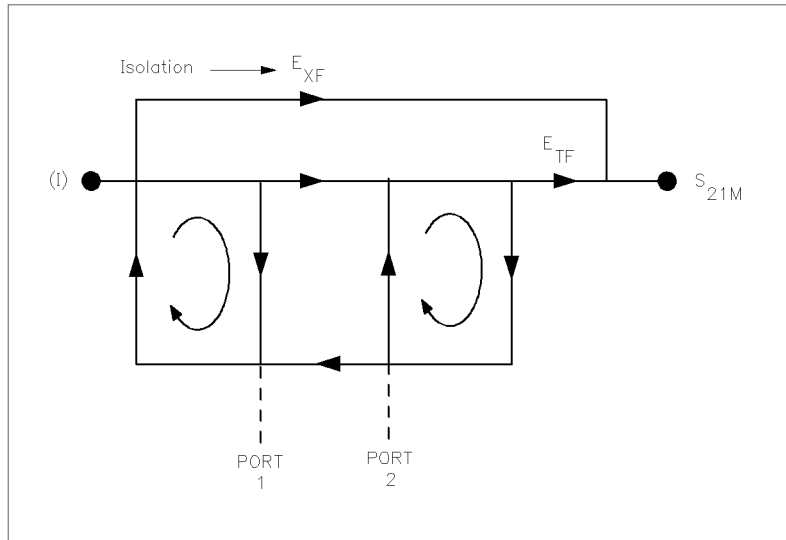

pg662d

Figure 6-44. Isolation E_{XF}

Thus there are two sets of error terms, forward and reverse, with each set consisting of six error terms, as follows:

- Directivity, E_{DF} (forward) and E_{DR} (reverse)
- Isolation, E_{XF} and E_{XR}
- Source Match, E_{SF} and E_{SR}
- Load Match, E_{LF} and E_{LR}
- Transmission Tracking, E_{TF} and E_{TR}
- Reflection Tracking, E_{RF} and E_{RR}

The analyzer's test set can measure both the forward and reverse characteristics of the test device without you having to manually remove and physically reverse the device. The full two-port error model illustrated in Figure 6-45 depicts how the analyzer effectively removes both the forward and reverse error terms for transmission and reflection measurements.

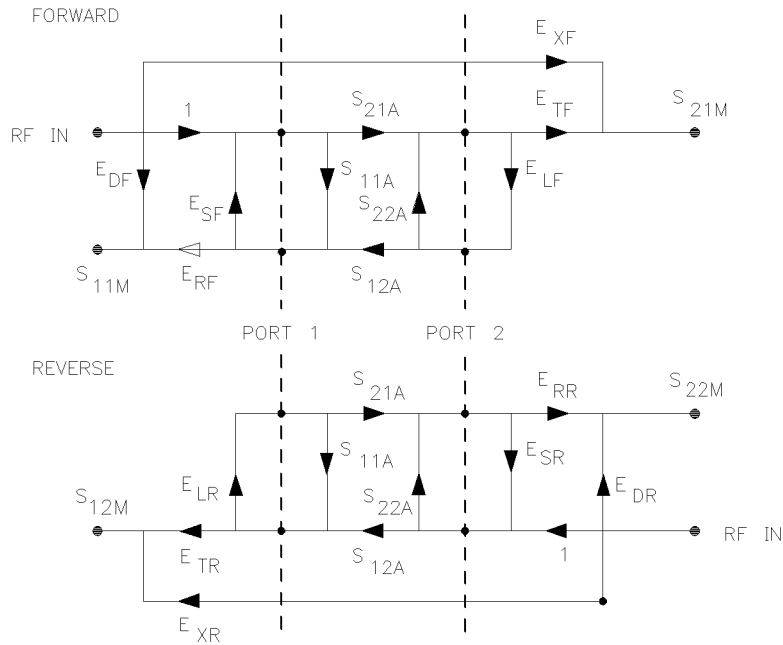

pg663d

Figure 6-45. Full Two-Port Error Model

Figure 6-46 shows the full two-port error model equations for all four S-parameters of a two-port device. Note that the mathematics for this comprehensive model use all forward and reverse error terms and measured values. Thus, to perform full error-correction for any one parameter, all four S-parameters must be measured.

Applications of these error models are provided in the calibration procedures described in Chapter 5, “Optimizing Measurement Results.”

$$S_{11A} = \frac{\left[\left(\frac{S_{11M} - E_{DF}}{E_{RF}} \right) \left[1 + \left(\frac{S_{22M} - E_{DR}}{E_{RR}} \right) E_{SR} \right] \right] - \left[\left(\frac{S_{21M} - E_{XF}}{E_{TF}} \right) \left(\frac{S_{12M} - E_{XR}}{E_{TR}} \right) E_{LF} \right]}{\left[1 + \left(\frac{S_{11M} - E_{DF}}{E_{RF}} \right) E_{SF} \right] \left[1 + \left(\frac{S_{22M} - E_{DR}}{E_{RR}} \right) E_{SR} \right] - \left[\left(\frac{S_{21M} - E_{XF}}{E_{TF}} \right) \left(\frac{S_{12M} - E_{XR}}{E_{TR}} \right) E_{LF} E_{LR} \right]}$$

$$S_{21A} = \frac{\left[1 + \left(\frac{S_{22M} - E_{DR}}{E_{RR}} \right) \left(E_{SR} - E_{LF} \right) \right] \left(\frac{S_{21M} - E_{XF}}{E_{TF}} \right)}{\left[1 + \left(\frac{S_{11M} - E_{DF}}{E_{RF}} \right) E_{SF} \right] \left[1 + \left(\frac{S_{22M} - E_{DR}}{E_{RR}} \right) E_{SR} \right] - \left[\left(\frac{S_{21M} - E_{XF}}{E_{TF}} \right) \left(\frac{S_{12M} - E_{XR}}{E_{TR}} \right) E_{LF} E_{LR} \right]}$$

$$S_{12A} = \frac{\left[1 + \left(\frac{S_{11M} - E_{DF}}{E_{RF}} \right) \left(E_{SF} - E_{LR} \right) \right] \left(\frac{S_{12M} - E_{XR}}{E_{TR}} \right)}{\left[1 + \left(\frac{S_{11M} - E_{DF}}{E_{RF}} \right) E_{SF} \right] \left[1 + \left(\frac{S_{22M} - E_{DR}}{E_{RR}} \right) E_{SR} \right] - \left[\left(\frac{S_{21M} - E_{XF}}{E_{TF}} \right) \left(\frac{S_{12M} - E_{XR}}{E_{TR}} \right) E_{LF} E_{LR} \right]}$$

$$S_{22A} = \frac{\left[\left(\frac{S_{22M} - E_{DR}}{E_{RR}} \right) \left[1 + \left(\frac{S_{11M} - E_{DF}}{E_{RF}} \right) E_{SF} \right] \right] - \left[\left(\frac{S_{21M} - E_{XF}}{E_{TF}} \right) \left(\frac{S_{12M} - E_{XR}}{E_{TR}} \right) E_{LR} \right]}{\left[1 + \left(\frac{S_{11M} - E_{DF}}{E_{RF}} \right) E_{SF} \right] \left[1 + \left(\frac{S_{22M} - E_{DR}}{E_{RR}} \right) E_{SR} \right] - \left[\left(\frac{S_{21M} - E_{XF}}{E_{TF}} \right) \left(\frac{S_{12M} - E_{XR}}{E_{TR}} \right) E_{LF} E_{LR} \right]}$$

pg6128d

Figure 6-46. Full Two-Port Error Model Equations

In addition to the errors removed by accuracy enhancement, other systematic errors exist due to limitations of dynamic accuracy, test set switch repeatability, and test cable stability. These, combined with random errors, also contribute to total system measurement uncertainty. Therefore, after accuracy enhancement procedures are performed, residual measurement uncertainties remain.

Calibration Considerations

Measurement Parameters

Calibration procedures are parameter-specific, rather than channel-specific. When a parameter is selected, the instrument checks the available calibration data, and uses the data found for that parameter. For example, if a transmission response calibration is performed for B/R, and an S_{11} 1-port calibration for A/R, the analyzer retains both calibration sets and corrects whichever parameter is displayed. Once a calibration has been performed for a specific parameter or input, measurements of that parameter remain calibrated in either channel, as long as stimulus values are coupled. In the response and response and isolation calibrations, the parameter must be selected before calibration; other correction procedures select parameters automatically. Changing channels during a calibration procedure invalidates the part of the procedure already performed.

Device Measurements

In calibration procedures that require measurement of several different devices, for example a short, an open, and a load, the order in which the devices are measured is not critical. Any standard can be re-measured, until the **DONE** key is pressed. The change in trace during measurement of a standard is normal.

Response and response and isolation calibrations require measurement of only one standard device. If more than one device is measured, only the data for the last device is retained.

Omitting Isolation Calibration

Isolation calibration can be omitted for most measurements, except where high dynamic range is a consideration. Use the following guidelines. When the measurement requires a dynamic range of:

- 90 dB: Omit isolation calibration for most measurements.
- 90 to 100 dB: Isolation calibration is recommended with test port power greater than 0 dBm. For this isolation calibration, averaging should be turned on with an averaging factor at least four times the measurement averaging factor. For example, use use an averaging factor of 16 for the isolation calibration, and then reduce the averaging factor to four for the measurement after calibration.
- 100 dB: Same as above, but alternate mode should be used. See page 5-53.

Saving Calibration Data

You should save the calibration data, either in the internal non-volatile memory or on a disk. If you do not save it, it will be lost if you select another calibration procedure for the same channel, or if you change stimulus values. Instrument preset, power on, and instrument state recall will also clear the calibration data.

The Calibration Standards

During measurement calibration, the analyzer measures actual, well-defined standards and mathematically compares the results with ideal “models” of those standards. The differences are separated into error terms which are later removed during error-correction. Most of the differences are due to systematic errors - repeatable errors introduced by the analyzer, test set, and cables - which are correctable.

The standard devices required for system calibration are available in compatible calibration kits with different connector types. Each kit contains at least one short circuit, one open circuit, and an impedance-matched load. In kits that require adapters for interface to the test set ports, the adapters are phase-matched for calibration prior to measurement of non-insertable and non-reversible devices. Other standard devices can be used by specifying their characteristics in a user-defined kit, as described later in this section under “Modifying Calibration Kits.”

The accuracy improvement of the correction is limited by the quality of the standard devices, and by the connection techniques used. For maximum accuracy, use a torque wrench for final connections.

Frequency Response of Calibration Standards

In order for the response of a reference standard to show as a dot on the smith chart display format, it must have no phase shift with respect to frequency. Standards that exhibit such “perfect” response are the following:

- 7-mm short (with no offset)
- type-N male short (with no offset)

There are two reasons why other types of reference standards show phase shift after calibration:

- The reference plane of the standard is electrically offset from the mating plane of the test port. Such devices exhibit the properties of a small length of transmission line, including a certain amount of phase shift.
- The standard is an open termination, which by definition exhibits a certain amount of fringe capacitance (and therefore phase shift). Open terminations which are offset from the mating plane will exhibit a phase shift due to the offset in addition to the phase shift caused by the fringe capacitance.

The most important point to remember is that these properties will not affect your measurements. The analyzer compensates for them during measurement. As a result, if these standards are measured after a calibration, they will not appear to be “perfect” shorts or opens. This is an indication that *your analyzer is working properly* and that it has successfully performed a calibration. Figure 6-47 shows sample displays of various calibration standards after calibration.

Electrical Offset

Some standards have reference planes that are electrically offset from the mating plane of the test port. These devices will show a phase shift with respect to frequency. Table 6-3 shows which reference devices exhibit an electrical offset phase shift. The amount of phase shift can be calculated with the formula:

$$\phi = (360 \times f \times l)/c \text{ where:}$$

f = frequency

l = electrical length of the offset

c = speed of light (3×10^8 meters/second)

Fringe Capacitance

All open circuit terminations exhibit a phase shift over frequency due to fringe capacitance. Offset open circuits have increased phase shift because the offset acts as a small length of transmission line. Refer to Table 6-3.

Table 6-3. Calibration Standard Types and Expected Phase Shift

Test Port Connector Type	Standard Type	Expected Phase Shift
7-mm Type-N male	Short	180°
3.5-mm male 3.5-mm female 2.4-mm male 2.4-mm female Type-N female 75Ω Type-N female	Offset Short	$180^\circ + \frac{(360 \times f \times l)}{c}$
7-mm Type N-male	Open	$0^\circ + \phi_{\text{capacitance}}$
3.5-mm male 3.5-mm female 2.4-mm male 2.4-mm female Type N-female 75Ω Type-N female	Offset Open	$0^\circ + \phi_{\text{capacitance}} + \frac{(360 \times f \times l)}{c}$ <i>Open</i> $0^\circ + \phi_{\text{capacitance}} + \frac{(360 \times f \times l)}{c}$

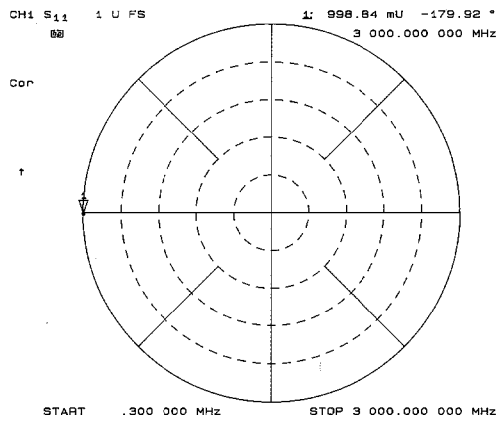

**7 mm or Type-N Male
 Short (No Offset)**

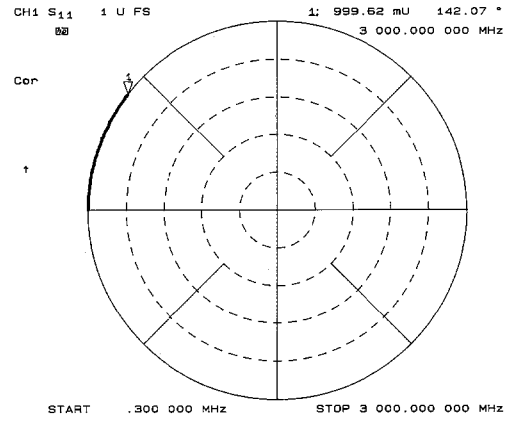

**Type-N Female,
 3.5 mm Male or Female Offset Short**

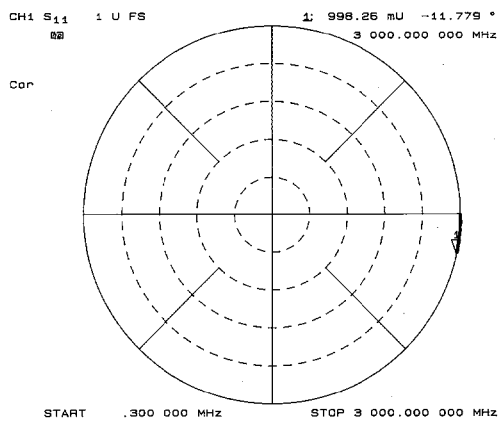

**7 mm or Type-N Male
 Open (No Offset)**

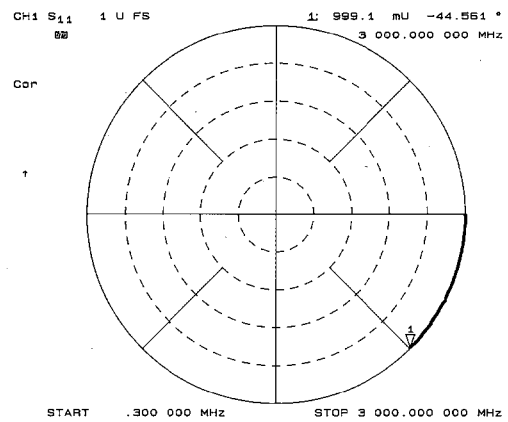

**Type-N Female,
 3.5 mm Male or Female Offset Open**

pg6185_c

Figure 6-47. Typical Responses of Calibration Standards after Calibration

How Effective Is Accuracy Enhancement?

The uncorrected performance of the analyzer is sufficient for many measurements. However, the vector accuracy enhancement procedures described in Chapter 5, "Optimizing Measurement Results," will provide a much higher level of accuracy. Figure 6-48 through Figure 6-50 illustrate the improvements that can be made in measurement accuracy by using a more complete calibration routine. Figure 6-48a shows a measurement in log magnitude format with a response calibration only. Figure 6-48b shows the improvement in the same measurement using an S_{11} one-port calibration. Figure 6-49a shows the measurement on a Smith chart with response calibration only, and Figure 6-49b shows the same measurement with an S_{11} one-port calibration.

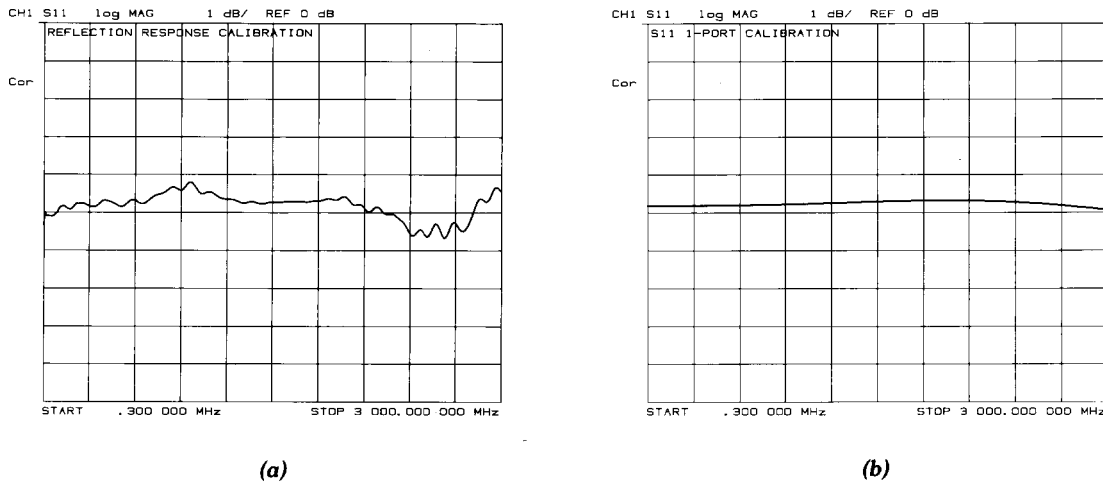

pg6166_c

Figure 6-48. Response versus S_{11} 1-Port Calibration on Log Magnitude Format

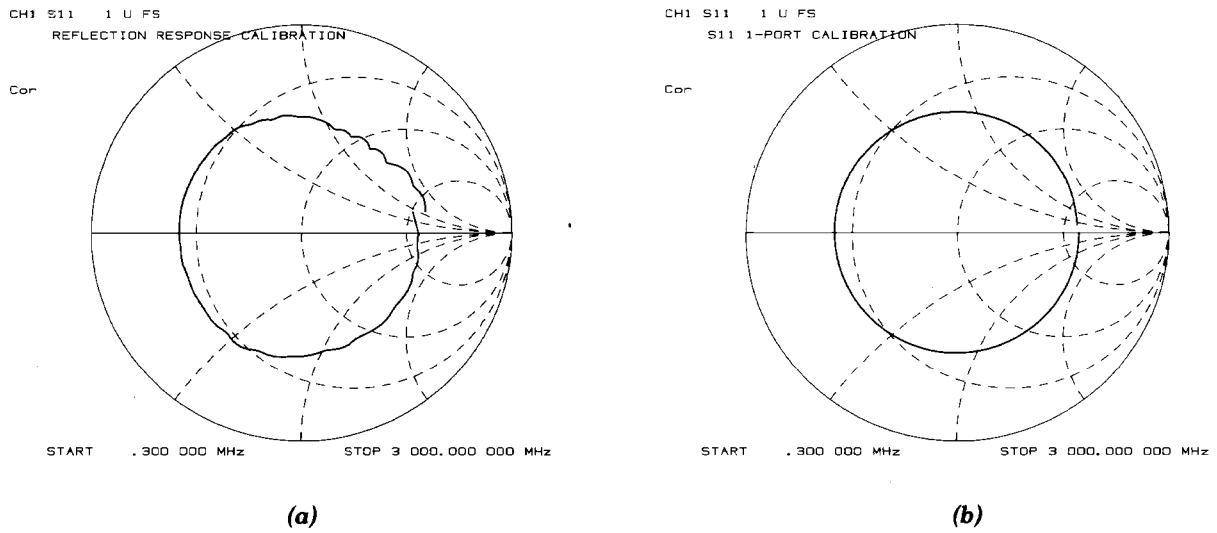

pg6167_c

Figure 6-49. Response versus S_{11} 1-Port Calibration on Smith Chart

Figure 6-50 shows the response of a device in a log magnitude format, using a response calibration in Figure 6-50a and a full two-port calibration in Figure 6-50b.

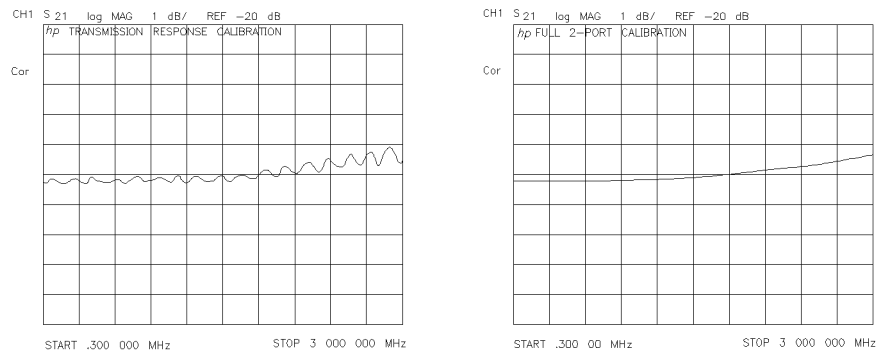

pg681d

Figure 6-50. Response versus Full Two-Port Calibration

Correcting for Measurement Errors

The **CAL** key provides access to the correction menu which leads to a series of menus that implement the error-correction concepts described in this section. Accuracy enhancement (error-correction) is performed as a calibration step before you measure a test device. When the **CAL** key is pressed, the correction menu is displayed.

The following softkeys are located within the correction menu:

- **CORRECTION ON off**
- **INTERPOL on OFF**
- **CALIBRATE MENU**
- **RESUME CAL SEQUENCE**
- **RECEIVER CAL**
- **CAL KIT []**
- **PWRMTR CAL [OFF]**
- **PORT EXTENSIONS**
- **VELOCITY FACTOR**
- **SET Z_0**
- **TEST SET SW []**
- **ALTERNATE A and B**
- **CHOP A and B**

Ensuring a Valid Calibration

Unless interpolated error-correction is on, measurement calibrations are valid only for a specific stimulus state, which must be set before a calibration has begun. The stimulus state consists of the selected frequency range, number of points, sweep time, output power, and sweep type. Changing the frequency range, number of points, or sweep type with correction on invalidates the calibration and turns it off. Changing the sweep time or output power changes the status notation **Cor** at the left of the screen to **C?**, to indicate that the calibration is in question. If correction is turned off or in question after the stimulus changes are made, pressing **CORRECTION ON off** recalls the original stimulus state for the current calibration.

Interpolated Error-correction

You can activate the interpolated error-correction feature with the **INTERPOL ON off** softkey. This feature allows you to select a subset of the frequency range or a different number of points without recalibration. When interpolation is on, the system errors for the newly selected frequencies are calculated from the system errors of the original calibration.

System performance is unspecified when using interpolated error-correction. The quality of the interpolated error-correction is dependent on the amount of phase shift and the amplitude change between measurement points. If phase shift is no greater than 180° per approximately 5 measurement points, interpolated error-correction offers a great improvement over uncorrected measurements. The accuracy of interpolated error-correction improves as the phase shift and amplitude change between adjacent points decrease. When you use the analyzer in linear frequency sweep, perform the original calibration with at least 67 points per 1 GHz of frequency span for greatest accuracy with interpolated error-correction.

Interpolated error-correction is available in three sweep modes: linear frequency, power sweep, and CW time.

Note If there is a valid correction array for a linear frequency sweep, this may be interpolated to provide correction at the CW frequency used in power sweep or CW time modes. This correction is part of the interpolated error-correction feature and is not specified.

The Calibrate Menu

There are twelve different error terms for a two-port measurement that can be corrected by accuracy enhancement in the analyzer. These are directivity, source match, load match, isolation, reflection tracking, and transmission tracking, each in both the forward and reverse direction. The analyzer has several different measurement calibration routines to characterize one or more of the systematic error terms and remove their effects from the measured data.

The calibrate menu allows you to perform the measurement calibration routines. These procedures range from a simple frequency response calibration to a full two-port calibration that effectively removes all twelve error terms.

Response Calibration

The response calibration, activated by pressing the **RESPONSE** softkey within the calibrate menu, provides a normalization of the test setup for reflection or transmission measurements. This calibration procedure may be adequate for measurement of well matched devices. This is the simplest error-correction to perform, and should be used when extreme measurement accuracy is not required.

Response and Isolation Calibration

The response and isolation calibration, activated by pressing the **RESPONSE & ISOL'N** softkey within the calibrate menu, provides a normalization for frequency response and crosstalk errors in transmission measurements, or frequency response and directivity errors in reflection measurements. This procedure may be adequate for measurement of well matched high-loss devices.

S₁₁ and S₂₂ One-Port Calibration

The S₁₁ and S₂₂ one-port calibration procedures, activated by pressing the **S11 1-PORT** or **S22 1-PORT** softkey within the calibrate menu, provide directivity, source match, and frequency response vector error-correction for reflection measurements. These procedures provide high accuracy reflection measurements of one-port devices or properly terminated two-port devices.

Full Two-Port Calibration

The full two-port calibration, activated by pressing the **FULL 2-PORT** softkey within the calibrate menu, provides directivity, source match, load match, isolation, and frequency response vector error-correction, in both forward and reverse directions, for transmission and reflection measurements of two-port devices. This calibration provides the best magnitude and phase measurement accuracy for both transmission and reflection measurements of two-port devices, and requires an S-parameter test set.

In this type of calibration, both forward and reverse measurements must be made. You have the option of setting the ratio of the number of forward (or reverse) sweeps versus the number of reverse (or forward) sweeps. To access this function, press **(CAL) MORE TESTSET SW** and enter the number of sweeps desired.

TRL*/LRM* Two-Port Calibration

The TRL*/LRM* two-port calibration, activated by pressing the **TRL*/LRM* 2-PORT** softkey within the calibrate menu, provides the ability to make calibrations using the TRL or LRM method. For more information, refer to “TRL*/LRM* Calibration,” located later in this section.

Restarting a Calibration

If you interrupt a calibration to go to another menu, such as averaging, you can continue the calibration by pressing the **RESUME CAL SEQUENCE** softkey in the correction menu.

Cal Kit Menu

The cal kit menu provides access to a series of menus used to specify the characteristics of calibration standards. The following softkeys are located within the cal kit menu:

- **SELECT CAL KIT**
- **SAVE USER KIT**
- **MODIFY []**

The Select Cal Kit Menu

Pressing the **SELECT CAL KIT** softkey within the cal kit menu provides access to the select cal kit menu. This menu allows you to select from several default calibration kits that have different connector types. These kits have predefined standards and are valid for most applications. It is not possible to overwrite these standard definitions.

The numerical definitions for most Hewlett-Packard calibration kits can be referenced in the calibration kit operating and service manuals, or can be viewed on the analyzer. The standard definitions can also be modified to any set of standards used.

Modifying Calibration Kits

Modifying calibration kits is necessary only if unusual standards (such as in TRL*) are used or the very highest accuracy is required. Unless a calibration kit model is provided with the calibration devices used, a solid understanding of error-correction and the system error model are absolutely essential to making modifications. You may use modifications to a predefined calibration kit by modifying the kit and saving it as a user kit. The original predefined calibration kit will remain unchanged.

Before attempting to modify calibration standard definitions, you should read application note 8510-5A to improve your understanding of modifying calibration kits. The part number of this application note is 5956-4352. Although the application note is written for the HP 8510 family of network analyzers, it also applies to the HP 8753D.

Several situations exist that may require a user-defined calibration kit:

- A calibration is required for a connector interface different from the four default calibration kits. (Examples: SMA, TNC, or waveguide.)
- A calibration with standards (or combinations of standards) that are different from the default calibration kits is required. (Example: Using three offset shorts instead of open, short, and load to perform a 1-port calibration.)
- The built-in standard models for default calibration kits can be improved or refined. Remember that the more closely the model describes the actual performance of the standard, the better the calibration. (Example: The 7 mm load is determined to be 50.4 ohms instead of 50.0 ohms.)

Definitions

The following are definitions of terms:

- A “standard” (represented by a number 1-8) is a specific, well-defined, physical device used to determine systematic errors. For example, standard 1 is a short in the 3.5 mm calibration kit. Standards are assigned to the instrument softkeys as part of a class.
- A standard “type” is one of five basic types that define the form or structure of the model to be used with that standard (short, open, load, delay/thru, and arbitrary impedance); standard 1 is of the type short in the 3.5 mm calibration kit.
- Standard “coefficients” are numerical characteristics of the standards used in the model selected. For example, the offset delay of the short is 32 ps in the 3.5 mm calibration kit.
- A standard “class” is a grouping of one or more standards that determines which of the eight standards are used at each step of the calibration. For example, standard number 2 and 8 usually makes up the $S_{11}A$ reflection class, which for type-N calibration kits are male and female shorts.

Procedure

The following steps are used to modify or define a user kit:

1. Select the predefined kit to be modified. (This is not necessary for defining a new calibration kit.)
2. Define the standards:
 - a. Define which “type” of standard it is.
 - b. Define the electrical characteristics (coefficients) of the standard.
3. Specify the class where the standard is to be assigned.

4. Store the modified calibration kit.

For a step by step procedure on how to modify calibration kits, refer to “Modifying Calibration Kit Standards” located in Chapter 5, “Optimizing Measurement Results.”

Modify Calibration Kit Menu

The **MODIFY []** softkey in the cal kit menu provides access to the modify calibration kit menu. This leads in turn to additional series of menus associated with modifying calibration kits. The following is a description of the softkeys located within this menu:

- **DEFINE STANDARD** makes the standard number the active function, and brings up the define standard menus. Before selecting a standard, a standard number must be entered. This number (1 to 8) is an arbitrary reference number used to reference standards while specifying a class. The standard numbers for the predefined calibration kits are as follows:

- 1 short (m)
- 2 open (m)
- 3 broadband load
- 4 thru
- 5 sliding load
- 6 lowband load
- 7 short (f)
- 8 open (f)

Note Although the numbering sequences are arbitrary, confusion can be minimized by using consistency. However, standard 5 is always a sliding load.

- **SPECIFY CLASS** leads to the specify class menu. After the standards are modified, use this key to specify a class to group certain standards.
- **LABEL CLASS** leads to the label class menu, to give the class a meaningful label for future reference.
- **LABEL KIT** leads to a menu for constructing a label for the user-modified cal kit. If a label is supplied, it will appear as one of the five softkey choices in the select cal kit menu. The approach is similar to defining a display title, except that the kit label is limited to ten characters.
- **TRL/LRM OPTION** brings up the TRL Option menu.
- **KIT DONE (MODIFIED)** terminates the calibration kit modification process, after all standards are defined and all classes are specified. Be sure to save the kit with the **SAVE USER KIT** softkey, if it is to be used later.

Define Standard Menus

Standard definition is the process of mathematically modeling the electrical characteristics (delay, attenuation, and impedance) of each calibration standard. These electrical characteristics (coefficients) can be mathematically derived from the physical dimensions and material of each calibration standard, or from its actual measured response. The parameters of the standards can be listed in Table 6-4.

Table 6-4. Standard Definitions

System $Z_0^a =$ _____

Calibration Kit Label: _____

Disk File Name: _____

STANDARD ^b		C0 ^e $\times 10^{-15}$ F	C1 ^e $\times 10^{-27}$ F/Hz	C2 ^e $\times 10^{-36}$ F/Hz ²	C3 ^e $\times 10^{-45}$ F/Hz ³	FIXED ^c SLIDING or OFFSET	TERM ^d IMPED Ω	OFFSET			FREQ (GHz)		COAX or WG	STND LABEL
NO.	TYPE							DELAY s	Z ₀ Ω	LOSS Ω/s	MIN	MAX		
1														
2														
3														
4														
5														
6														
7														
8														

^aEnsure system Z_0 of network analyzer is set to this value.

^bOpen, short, load, delay/thru, or arbitrary impedance.

^cLoad or arbitrary impedance only.

^dArbitrary impedance only, device terminating impedance.

^eOpen standard types only.

Each standard must be identified as one of five “types”: open, short, load, delay/thru, or arbitrary impedance.

After a standard number is entered, selection of the standard type will present one of five menus for entering the electrical characteristics (model coefficients) corresponding to that standard type, such as **OPEN**. These menus are tailored to the current type, so that only characteristics applicable to the standard type can be modified.

The following is a description of the softkeys located within the define standard menu:

- **OPEN** defines the standard type as an open, used for calibrating reflection measurements. Opens are assigned a terminal impedance of infinite ohms, but delay and loss offsets may still be added. Pressing this key also brings up a menu for defining the open, including its capacitance.

As a reflection standard, an open termination offers the advantage of broadband frequency coverage. At microwave frequencies, however, an open rarely has perfect reflection characteristics because fringing capacitance effects cause phase shift that varies with frequency. This can be observed in measuring an open termination after calibration, when an arc in the lower right circumference of the Smith chart indicates capacitive reactance. These effects are impossible to eliminate, but the calibration kit models include the open termination capacitance at all frequencies for compatible calibration kits. The capacitance model is a cubic polynomial, as a function of frequency, where the polynomial coefficients are user-definable. The capacitance model equation is:

$$C = (C0) + (C1 \times F) + (C2 \times F^2) + (C3 \times F^3)$$

where F is the measurement frequency.

The terms in the equation are defined with the specify open menu as follows:

- C0** allows you to enter the C0 term, which is the constant term of the cubic polynomial and is scaled by 10^{-15} Farads.
 - C1** allows you to enter the C1 term, expressed in F/Hz (Farads/Hz) and scaled by 10^{-27} .
 - C2** allows you to enter the C2 term, expressed in F/Hz² and scaled by 10^{-36} .
 - C3** allows you to enter the C3 term, expressed in F/Hz³ and scaled by 10^{-45} .
- **SHORT** defines the standard type as a short, for calibrating reflection measurements. Shorts are assigned a terminal impedance of 0 ohms, but delay and loss offsets may still be added.
 - **LOAD** defines the standard type as a load (termination). Loads are assigned a terminal impedance equal to the system characteristic impedance Z0, but delay and loss offsets may still be added. If the load impedance is not Z0, use the arbitrary impedance standard definition.
 - FIXED** defines the load as a fixed (not sliding) load.
 - SLIDING** defines the load as a sliding load. When such a load is measured during calibration, the analyzer will prompt for several load positions, and calculate the ideal load value from it.
 - OFFSET** defines the load as being offset.
 - **DELAY/THRU** defines the standard type as a transmission line of specified length, for calibrating transmission measurements.

- **ARBITRARY IMPEDANCE** defines the standard type to be a load, but with an arbitrary impedance (different from system Z0).

TERMINAL IMPEDANCE allows you to specify the (arbitrary) impedance of the standard, in ohms.

FIXED defines the load as a fixed (not sliding) load.

SLIDING defines the load as a sliding load. When such a load is measured during calibration, the analyzer will prompt for several load positions, and calculate the ideal load value from it.

Any standard type can be further defined with offsets in delay, loss, and standard impedance; assigned minimum or maximum frequencies over which the standard applies; and defined as coax or waveguide. The **SPECIFY OFFSET** softkey provides access to the specify offset menu (described next).

The **LABEL STD** softkey allows you to define a distinct label for each standard, so that the analyzer can prompt the user with explicit standard labels during calibration (such as SHORT). The function is similar to defining a display title, except that the label is limited to ten characters.

After each standard is defined, including offsets, the **STD DONE (DEFINED)** softkey will terminate the standard definition.

Specify Offset Menu

The specify offset menu allows additional specifications for a user-defined standard. Features specified in this menu are common to all five types of standards.

Offsets may be specified with any standard type. This means defining a uniform length of transmission line to exist between the standard being defined and the actual measurement plane. (Example: a waveguide short circuit terminator, offset by a short length of waveguide.) For reflection standards, the offset is assumed to be between the measurement plane and the standard (one-way only). For transmission standards, the offset is assumed to exist between the two reference planes (in effect, the offset is the thru). Three characteristics of the offset can be defined: its delay (length), loss, and impedance.

In addition, the frequency range over which a particular standard is valid can be defined with a minimum and maximum frequency. This is particularly important for a waveguide standard, since its behavior changes rapidly beyond its cutoff frequency. Note that several band-limited standards can together be defined as the same “class” (see specify class menu). Then, if a measurement calibration is performed over a frequency range exceeding a single standard, additional standards can be used for each portion of the range.

Lastly, the standard must be defined as either coaxial or waveguide. If it is waveguide, dispersion effects are calculated automatically and included in the standard model.

The following is a description of the softkeys located within the specify offset menu:

- **OFFSET DELAY** allows you to specify the one-way electrical delay from the measurement (reference) plane to the standard, in seconds (s). (In a transmission standard, offset delay is the delay from plane to plane.) Delay can be calculated from the precise physical length of the offset, the permittivity constant of the medium, and the speed of light.

In coax, group delay is considered constant. In waveguide, however, group delay is dispersive, that is, it changes significantly as a function of frequency. Hence, for a waveguide standard, offset delay must be defined as though it were a TEM wave (without dispersion).

- **OFFSET LOSS** allows you to specify energy loss, due to skin effect, along a one-way length of coax offset. The value of loss is entered as ohms/nanosecond (or Giga ohms/second) at 1 GHz. (Such losses are negligible in waveguide, so enter 0 as the loss offset.)
- **OFFSET Z0** allows you to specify the characteristic impedance of the coax offset. (Note: This is not the impedance of the standard itself.) For waveguide, the offset impedance as well as the system Z0 must always be set to 1 Ω .
- **MINIMUM FREQUENCY** allows you to define the lowest frequency at which the standard can be used during measurement calibration. In waveguide, this must be the lower cutoff frequency of the standard, so that the analyzer can calculate dispersive effects correctly (see **OFFSET DELAY** above).
- **MAXIMUM FREQUENCY** allows you to define the highest frequency at which the standard can be used during measurement calibration. In waveguide, this is normally the upper cutoff frequency of the standard.
- **COAX** defines the standard (and the offset) as coaxial. This causes the analyzer to assume linear phase response in any offsets.
- **WAVEGUIDE** defines the standard (and the offset) as rectangular waveguide. This causes the analyzer to assume a dispersive delay (see **OFFSET DELAY** above).

Label Standard Menu

This menu allows you to label (reference) individual standards during the menu-driven measurement calibration sequence. The labels are user-definable using a character set shown on the display that includes letters, numbers, and some symbols, and they may be up to ten characters long. The analyzer will prompt you to connect standards using these labels, so they should be meaningful to you, and distinct for each standard.

By convention, when sexed connector standards are labeled male (m) or female (f), the designation refers to the test port connector sex, not the connector sex of the standard.

Specify Class Menu

Once a standard has been defined, it must be assigned to a standard “class.” This is a group of from one to seven standards that is required to calibrate for a single error term. The standards within a single class can be assigned to the locations listed in Table 6-5 according to their standard reference numbers.

A class often consists of a single standard, but may be composed of more than one standard if band-limited standards are used. For example, if there were two load standards – a fixed load for low frequencies, and a sliding load for high frequencies – then that class would have two standards.

Table 6-5. Standard Class Assignments

Calibration Kit Label: _____

Disk File Name: _____

Class	Standard Reference Numbers								Standard Class Label
	1	2	3	4	5	6	7	8	
S ₁₁ A									
S ₁₁ B									
S ₁₁ C									
S ₂₂ A									
S ₂₂ B									
S ₂₂ C									
Forward Transmission									
Reverse Transmission									
Forward Match									
Reverse Match									
Response									
Response and Isolation									
TRL thru									
TRL reflect									
TRL line or match									

The number of standard classes required depends on the type of calibration being performed, and is identical to the number of error terms corrected. A response calibration requires only one class, and the standards for that class may include an open, or short, or thru. A 1-port calibration requires three classes. A full 2-port calibration requires 10 classes, not including two for isolation.

The number of standards that can be assigned to a given class may vary from none (class not used) to one (simplest class) to seven. When a certain class of standards is required during calibration, the analyzer will display the labels for all the standards in that class (except when the class consists of a single standard). This does not, however, mean that all standards in a class must be measured during calibration. Unless band-limited standards are used, only a single standard per class is required.

Note It is often simpler to keep the number of standards per class to the bare minimum needed (often one) to avoid confusion during calibration.

Each class can be given a user-definable label as described under label class menus.

Standards are assigned to a class simply by entering the standard's reference number (established while defining a standard) under a particular class. The following is a description of the softkeys located within the specify class menu:

- **S11A** allows you to enter the standard numbers for the first class required for an S₁₁ 1-port calibration. (For default calibration kits, this is the open.)

- **S11B** allows you to enter the standard numbers for the second class required for an S_{11} 1-port calibration. (For default calibration kits, this is the short.)
- **S11C** allows you to enter the standard numbers for the third class required for an S_{11} 1-port calibration. (For default calibration kits, this is the load.)
- **S22A** allows you to enter the standard numbers for the first class required for an S_{22} 1-port calibration. (For default calibration kits, this is the open.)
- **S22B** allows you to enter the standard numbers for the second class required for an S_{22} 1-port calibration. (For default calibration kits, this is the short.)
- **S22C** allows you to enter the standard numbers for the third class required for an S_{22} 1-port calibration. (For default calibration kits, this is the load.)
- **FWD TRANS.** allows you to enter the standard numbers for the forward transmission thru calibration. (For default calibration kits, this is the thru.)
- **REV TRANS.** allows you to enter the standard numbers for the reverse transmission (thru) calibration. (For default calibration kits, this is the thru.)
- **FWD MATCH** allows you to enter the standard numbers for the forward match (thru) calibration. (For default calibration kits, this is the thru.)
- **REV MATCH** allows you to enter the standard numbers for the reverse match (thru) calibration. (For default calibration kits, this is the thru.)
- **RESPONSE** allows you to enter the standard numbers for a response calibration. This calibration corrects for frequency response in either reflection or transmission measurements, depending on the parameter being measured when a calibration is performed. (For default kits, the standard is either the open or short for reflection measurements, or the thru for transmission measurements.)
- **RESPONSE & ISOL'N** allows you to enter the standard numbers for a response & isolation calibration. This calibration corrects for frequency response and directivity in reflection measurements, or frequency response and isolation in transmission measurements.
- **TRL THRU** allows you to enter the standard numbers for a TRL thru calibration.
- **TRL REFLECT** allows you to enter the standard numbers for a TRL reflect calibration.
- **TRL LINE OR MATCH** allows you to enter the standard numbers for a TRL line or match calibration.

Label Class Menu

The label class menus are used to define meaningful labels for the calibration classes. These then become softkey labels during a measurement calibration. Labels can be up to ten characters long.

Label Kit Menu

This **LABEL KIT** softkey within the modify cal kit menu, provides access to this menu. It is identical to the label class menu and the label standard menu described above. It allows definition of a label up to eight characters long.

After a new calibration kit has been defined, be sure to specify a label for it. Choose a label that describes the connector type of the calibration devices. This label will then appear in the

CAL KIT [] softkey label in the correction menu and the MODIFY [] label in the select cal kit menu. It will be saved with calibration sets.

Verify performance

Once a measurement calibration has been generated with a user-defined calibration kit, its performance should be checked before making device measurements. To check the accuracy that can be obtained using the new calibration kit, a device with a well-defined frequency response (preferably unlike any of the standards used) should be measured. The verification device must not be one of the calibration standards: measurement of one of these standards is merely a measure of repeatability.

To achieve more complete verification of a particular measurement calibration, accurately known verification standards with a diverse magnitude and phase response should be used. National standard traceable or HP standards are recommended to achieve verifiable measurement accuracy.

Note The published specifications for the HP 8753D network analyzer system include accuracy enhancement with compatible calibration kits. Measurement calibrations made with user-defined or modified calibration kits are not subject to the HP 8753D specifications, although a procedure similar to the system verification procedure may be used.

TRL*/LRM* Calibration

The HP 8753D RF network analyzer has the capability of making calibrations using the “TRL” (thru-reflect-line) method. This section contains information on the following subjects:

- Why Use TRL Calibration?
- TRL Terminology
- How TRL*/LRM* Calibration Works
- Improving Raw Source Match and Load Match For TRL*/LRM* Calibration
- The TRL Calibration Procedure
 - Requirements for TRL Standards
 - TRL Options

Why Use TRL Calibration?

This method is convenient in that calibration standards can be fabricated for a specific measurement environment, such as a transistor test fixture or microstrip. Microstrip devices in the form of chips, MMIC's, packaged transistors, or beam-lead diodes cannot be connected directly to the coaxial ports of the analyzer. The device under test (DUT) must be physically connected to the network analyzer by some kind of transition network or fixture. Calibration for a fixtured measurement in microstrip presents additional difficulties.

A calibration at the coaxial ports of the network analyzer removes the effects of the network analyzer and any cables or adapters before the fixture; however, the effects of the fixture itself are not accounted for. An in-fixture calibration is preferable, but high-quality Short-Open-Load-Thru (SOLT) standards are not readily available to allow a conventional Full 2-port calibration of the system at the desired measurement plane of the device. In microstrip, a short circuit is inductive, an open circuit radiates energy, and a high-quality purely resistive load is difficult to produce over a broad frequency range. The Thru-Reflect-Line (TRL) 2-port calibration is an alternative to the traditional SOLT Full 2-port calibration technique that utilizes simpler, more convenient standards for device measurements in the microstrip environment.

For coaxial, waveguide and other environments where high-quality impedance standards are readily available, the traditional short, open, load, thru (SOLT) method provides the most accurate results since all of the significant systematic errors are reduced. This method is implemented in the form of the S_{11} 1-port, S_{22} 1-port, and full 2-port calibration selections.

In all measurement environments, the user must provide calibration standards for the desired calibration to be performed. The advantage of TRL is that only three standards need to be characterized as opposed to 4 in the traditional open, short, load, and thru full 2-port calibrations. Further, the requirements for characterizing the T, R, and L standards are less stringent and these standards are more easily fabricated.

TRL Terminology

Notice that the letters TRL, LRL, LRM, etc. are often interchanged, depending on the standards used. For example, “LRL” indicates that two lines and a reflect standard are used; “TRM” indicates that a thru, reflection and match standards are used. All of these refer to the same basic method.

How TRL*/LRM* Calibration Works

The TRL*/LRM* calibration used in the HP 8753D relies on the characteristic impedance of simple transmission lines rather than on a set of discrete impedance standards. Since transmission lines are relatively easy to fabricate (in a microstrip, for example), the impedance of these lines can be determined from the physical dimensions and substrate's dielectric constant.

TRL* Error Model

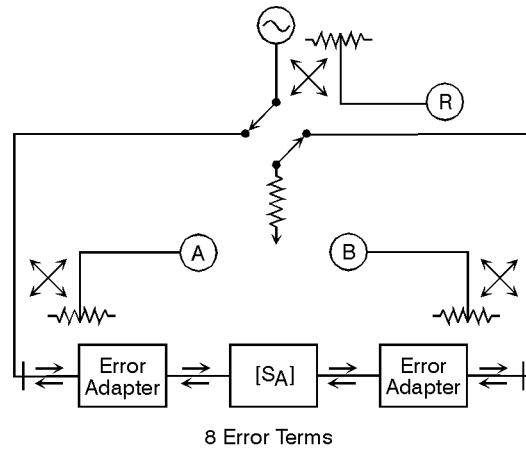

pb6120d

Figure 6-51.
HP 8753D functional block diagram for a 2-port error-corrected measurement system

For an HP 8753D TRL* 2-port calibration, a total of 10 measurements are made to quantify eight unknowns (not including the two isolation error terms). Assume the two transmission leakage terms, E_{XF} and E_{XR} , are measured using the conventional technique. The eight TRL error terms are represented by the error adapters shown in Figure 6-52. Although this error model is slightly different from the traditional Full 2-port 12-term model, the conventional error terms may be derived from it. For example, the forward reflection tracking (E_{RF}) is represented by the product of ϵ_{10} and ϵ_{01} . Also notice that the forward source match (E_{SF}) and reverse load match (E_{LR}) are both represented by ϵ_{11} , while the reverse source match (E_{SR}) and forward load match (E_{LF}) are both represented by ϵ_{22} . In order to solve for these eight unknown TRL error terms, eight linearly independent equations are required.

The first step in the TRL* 2-port calibration process is the same as the transmission step for a Full 2-port calibration. For the thru step, the test ports are connected together directly (zero length thru) or with a short length of transmission line (non-zero length thru) and the transmission frequency response and port match are measured in both directions by measuring all four S-parameters.

For the reflect step, identical high reflection coefficient standards (typically open or short circuits) are connected to each test port and measured (S_{11} and S_{22}).

For the line step, a short length of transmission line (different in length from the thru) is inserted between port 1 and port 2 and again the frequency response and port match are measured in both directions by measuring all four S-parameters.

In total, ten measurements are made, resulting in ten independent equations. However, the TRL error model has only eight error terms to solve for. The characteristic impedance of the

line standard becomes the measurement reference and, therefore, has to be assumed ideal (or known and defined precisely).

At this point, the forward and reverse directivity (E_{DF} and E_{DR}), transmission tracking (E_{TF} and E_{TR}), and reflection tracking (E_{RF} and E_{RR}) terms may be derived from the TRL error terms. This leaves the isolation (E_{XF} and E_{XR}), source match (E_{SF} and E_{SR}) and load match (E_{LF} and E_{LR}) terms to discuss.

Isolation

Two additional measurements are required to solve for the isolation terms (E_{XF} and E_{XR}). Isolation is characterized in the same manner as the Full 2-port calibration. Forward and reverse isolation are measured as the leakage (or crosstalk) from port 1 to port 2 with each port terminated. The isolation part of the calibration is generally only necessary when measuring high loss devices (greater than 70 dB).

Note **If an isolation calibration is performed, the fixture leakage must be the same during the isolation calibration and the measurement.**

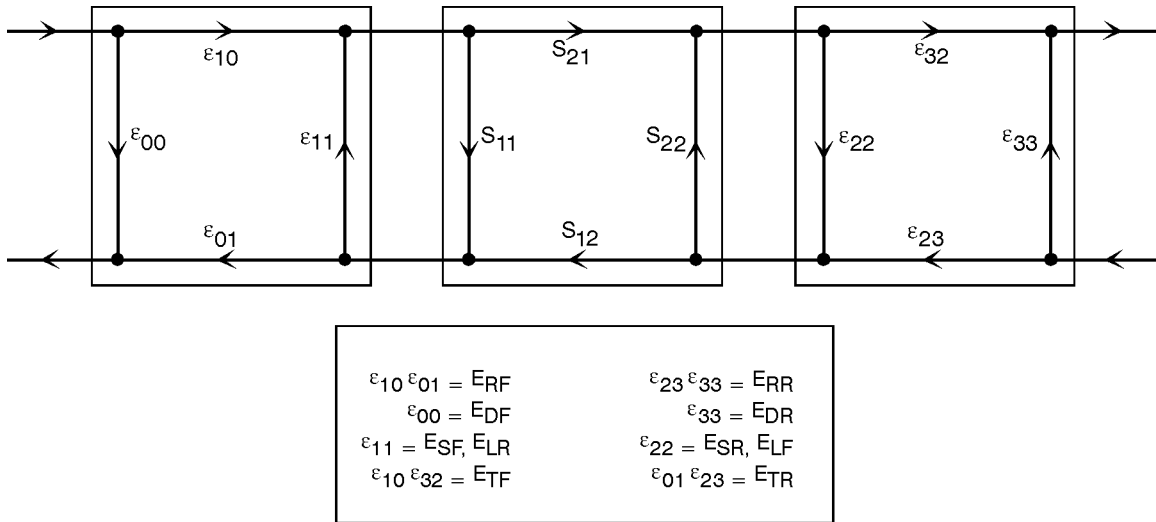

pb6121d

Figure 6-52. 8-term TRL error model and generalized coefficients

Source match and load match

A TRL calibration assumes a perfectly balanced test set architecture as shown by the term which represents both the forward source match (E_{SF}) and reverse load match (E_{LR}) and by the ϵ_{22} term which represents both the reverse source match (E_{SR}) and forward load match (E_{LF}). However, in any switching test set, the source and load match terms are not equal because the transfer switch presents a different terminating impedance as it is changed between port 1 and port 2.

Because the standard HP 8753D network analyzer is based on a three-sampler receiver architecture, it is not possible to differentiate the source match from the load match terms. The terminating impedance of the switch is assumed to be the same in either direction. Therefore, the test port mismatch cannot be fully corrected. An assumption is made that:

forward source match (E_{SF}) = reverse load match (E_{LR}) = ϵ_{11}

reverse source match (E_{SR}) = forward load match (E_{LF}) = ϵ_{22}

For a fixture, TRL* can eliminate the effects of the fixture's loss and length, but does not completely remove the effects due to the mismatch of the fixture.

Note	Because the TRL technique relies on the characteristic impedance of transmission lines, the mathematically equivalent method LRM (for line-reflect-match) may be substituted for TRL. Since a well matched termination is, in essence, an infinitely long transmission line, it is well suited for low (RF) frequency calibrations. Achieving a long line standard for low frequencies is often times physically impossible.
-------------	--

Improving Raw Source Match and Load Match For TRL*/LRM* Calibration

A technique that can be used to improve the raw test port mismatch is to add high quality fixed attenuators. The effective match of the system is improved because the fixed attenuators usually have a return loss that is better than that of the network analyzer. Additionally, the attenuators provide some isolation of reflected signals. The attenuators also help to minimize the difference between the port source match and load match, making the error terms more equivalent.

With the attenuators in place, the effective port match of the system is improved so that the mismatch of the fixture transition itself dominates the measurement errors after a calibration.

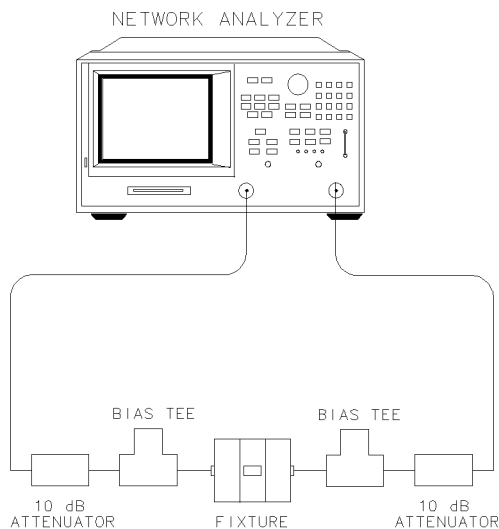

pg6263d

Figure 6-53. Typical Measurement Set up

If the device measurement requires bias, it will be necessary to add external bias tees between the fixed attenuators and the fixture. The internal bias tees of the analyzer will not pass the bias properly through the external fixed attenuators. Be sure to calibrate with the external bias tees in place (no bias applied during calibration) to remove their effect from the measurement.

Because the bias tees must be placed after the attenuators, they essentially become part of the fixture. Therefore, their mismatch effects on the measurement will not be improved by the attenuators.

Although the fixed attenuators improve the raw mismatch of the network analyzer system, they also degrade the overall measurement dynamic range.

This effective mismatch of the system after calibration has the biggest effect on reflection measurements of highly reflective devices. Likewise, for well matched devices, the effects of mismatch are negligible. This can be shown by the following approximation:

$$\text{Reflection magnitude uncertainty} = E_D + E_R S_{11} + E_S (S_{11})^2 + E_L S_{21} S_{12}$$

$$\text{Transmission magnitude uncertainty} = E_X + E_T S_{21} + E_S S_{11} S_{21} + E_L S_{22} S_{21}$$

where:

E_D = effective directivity

E_R = effective reflection tracking

E_S = effective source match

E_L = effective load match

E_X = effective crosstalk

E_T = effective transmission tracking

S_{xx} = S-parameters of the device under test

The TRL Calibration Procedure

Requirements for TRL Standards

When building a set of TRL standards for a microstrip or fixture environment, the requirements for each of these standard types must be satisfied.

Types	Requirements
THRU (Zero length)	<ul style="list-style-type: none"><input type="checkbox"/> No loss. Characteristic impedance (Z_0) need not be known.<input type="checkbox"/> $S_{21} = S_{12} = 1 \angle 0^\circ$<input type="checkbox"/> $S_{11} = S_{22} = 0$
THRU (Non-zero length)	<ul style="list-style-type: none"><input type="checkbox"/> Z_0 of the thru must be the same as the line. (If they are not the same, the average impedance is used.)<input type="checkbox"/> Attenuation of the thru need not be known.<input type="checkbox"/> If the thru is used to set the reference plane, the insertion phase or electrical length must be well-known and specified. If a non-zero length thru is specified to have zero delay, the reference plane is established in the middle of the thru.
REFLECT	<ul style="list-style-type: none"><input type="checkbox"/> Reflection coefficient (Γ) magnitude is optimally 1.0, but need not be known.<input type="checkbox"/> Phase of Γ must known and specified to within $\pm 1/4$ wavelength or $\pm 90^\circ$. During computation of the error model, the root choice in the solution of a quadratic equation is based on the reflection data. An error in definition would show up as a 180° error in the measured phase.<input type="checkbox"/> Γ must be identical on both ports.<input type="checkbox"/> If the reflect is used to set the reference plane, the phase response must be well-known and specified.
LINE/MATCH (LINE)	<ul style="list-style-type: none"><input type="checkbox"/> Z_0 of the line establishes the reference impedance of the measurement (i.e. $S_{11} = S_{22} = 0$). The calibration impedance is defined to be the same as Z_0 of the line. If the Z_0 is known but not the desired value (i.e., not equal to 50Ω), the SYSTEMS Z_0 selection under the TRL/LRM options menu is used.<input type="checkbox"/> Insertion phase of the line must not be the same as the thru (zero length or non-zero length). The difference between the thru and line must be between $(20^\circ \text{ and } 160^\circ) \pm n \times 180^\circ$. Measurement uncertainty will increase significantly when the insertion phase nears 0 or an integer multiple of 180°.<input type="checkbox"/> Optimal line length is $1/4$ wavelength or 90° of insertion phase relative to the thru at the middle of the desired frequency span.<input type="checkbox"/> Usable bandwidth for a single thru/line pair is 8:1 (frequency span:start frequency).<input type="checkbox"/> Multiple thru/line pairs (Z_0 assumed identical) can be used to extend the bandwidth to the extent transmission lines are available.<input type="checkbox"/> Attenuation of the line need not be known.<input type="checkbox"/> Insertion phase must be known and specified within $\pm 1/4$ wavelength or $\pm 90^\circ$.
LINE/MATCH (MATCH)	<ul style="list-style-type: none"><input type="checkbox"/> Z_0 of the match establishes the reference impedance of the measurement.<input type="checkbox"/> Γ must be identical on both ports.

Fabricating and defining calibration standards for TRL/LRM

When calibrating a network analyzer, the actual calibration standards must have known physical characteristics. For the reflect standard, these characteristics include the offset in electrical delay (seconds) and the loss (ohms/second of delay). The characteristic impedance, **OFFSET Z0**, is not used in the calculations in that it is determined by the line standard. The reflection coefficient magnitude should optimally be 1.0, but need not be known since the same reflection coefficient magnitude must be applied to both ports.

The thru standard may be a zero-length or known length of transmission line. The value of length must be converted to electrical delay, just like that done for the reflect standard. The loss term must also be specified.

The line standard must meet specific frequency related criteria, in conjunction with the length used by the thru standard. In particular, the insertion phase of the line must not be the same as the thru. The optimal line length is 1/4 wavelength (90 degrees) relative to a zero length thru at the center frequency of interest, and between 20 and 160 degrees of phase difference over the frequency range of interest. (Note: these phase values can be $\pm N \times 180$ degrees where N is an integer.) If two lines are used (LRL), the difference in electrical length of the two lines should meet these optimal conditions. Measurement uncertainty will increase significantly when the insertion phase nears zero or is an integer multiple of 180 degrees, and this condition is not recommended.

For a transmission media that exhibits linear phase over the frequency range of interest, the following expression can be used to determine a suitable line length of one-quarter wavelength at the center frequency (which equals the sum of the start frequency and stop frequency divided by 2):

$$\text{Electrical length (cm)} = (\text{LINE} - 0 \text{ length THRU})$$

$$\text{Electrical length (cm)} = \frac{(15000 \times VF)}{f1(\text{MHz}) + f2(\text{MHz})}$$

let:

$$f1 = 1000 \text{ MHz}$$

$$f2 = 2000 \text{ MHz}$$

$$VF = \text{Velocity Factor} = 1 \text{ (for this example)}$$

Thus, the length to initially check is 5 cm.

Next, use the following to verify the insertion phase at f1 and f2:

$$\text{Phase (degrees)} = \frac{(360 \times f \times l)}{v}$$

where:

f = frequency

l = length of line

v = velocity = speed of light \times velocity factor

which can be reduced to the following using frequencies in MHz and length in centimeters:

$$\text{Phase (degrees) approx} = \frac{0.012 \times f(\text{MHz}) \times l(\text{cm})}{VF}$$

So for an air line (velocity factor approximately 1) at 1000 MHz, the insertion phase is 60 degrees for a 5 cm line; it is 120 degrees at 2000 MHz. This line would be a suitable line standard.

For microstrip and other fabricated standards, the velocity factor is significant. In those cases, the phase calculation must be divided by that factor. For example, if the dielectric constant for a substrate is 10, and the corresponding "effective" dielectric constant for microstrip is 6.5, then the "effective" velocity factor equals 0.39 ($1 \div \text{square root of } 6.5$).

Using the first equation with a velocity factor of 0.39, the initial length to test would be 1.95 cm. This length provides an insertion phase at 1000 MHz of 60 degrees; at 2000 MHz, 120 degrees (the insertion phase should be the same as the air line because the velocity factor was accounted for when using the first equation).

Another reason for showing this example is to point out the potential problem in calibrating at low frequencies using TRL. For example, one-quarter wavelength is

$$Length (cm) = \frac{7500 \times VF}{f_c}$$

where:

f_c = center frequency

Thus, at 50 MHz,

$$Length (cm) = \frac{7500}{50 (MHz)} = 150 \text{ cm or } 1.5 \text{ m}$$

Such a line standard would not only be difficult to fabricate, but its long term stability and usability would be questionable as well.

Thus at lower frequencies and/or very broad band measurements, fabrication of a “match” or termination may be deemed more practical. Since a termination is, in essence, an infinitely long transmission line, it fits the TRL model mathematically, and is sometimes referred to as a “TRM” calibration.

The TRM calibration technique is related to TRL with the difference being that it bases the characteristic impedance of the measurement on a matched Z_0 termination instead of a transmission line for the third measurement standard. Like the TRL thru standard, the TRM THRU standard can either be of zero length or non-zero length. The same rules for thru and reflect standards used for TRL apply for TRM.

TRM has no inherent frequency coverage limitations which makes it more convenient in some measurement situations. Additionally, because TRL requires a different physical length for the thru and the line standards, its use becomes impractical for fixtures with contacts that are at a fixed physical distance from each other.

For information on how to modify calibration constants for TRL*/LRM*, and how to perform a TRL or TRM calibration, refer to Chapter 5, “Optimizing Measurement Results.”

TRL Options

The **TRL/LRM OPTION** softkey provides access to the TRL/LRM options menu. There are two selections under this menu:

- **CAL Z0:** (calibration Z_0)
- **SET REF:** (set reference)

The characteristic impedance used during the calibration can be referenced to either the line (or match) standard (**CAL Z0: LINE Z0**) or to the system (**CAL Z0: SYSTEM Z0**). The analyzer defaults to a calibration impedance that is equal to the line (or match) standard.

When the **CAL Z0: LINE Z0** is selected, the impedance of the line (or match) standard is assumed to match the system impedance exactly (the line standard is reflectionless). After a calibration, all measurements are referenced to the impedance of the line standard. For example, when the line standard is remeasured, the response will appear at the center of the Smith chart. When **CAL Z0: LINE Z0** is selected, the values entered for **SET Z0** (under CAL menu) and **OFFSET Z0** (within the define standard menu) are ignored.

CAL Z0: SYSTEM Z0 is selected when the desired measurement impedance differs from the impedance of the line standard. This requires a knowledge of the exact value of the Z_0 of the line. The system reference impedance is set using **SET Z0** under the calibration menu. The actual impedance of the line is set by entering the real part of the line impedance as the **OFFSET Z0** within the define standard menu. For example, if the line was known to have a characteristic impedance of 51Ω (**OFFSET Z0** = 51Ω), it could still be used to calibrate for a 50Ω measurement (**SET Z0** = 50Ω). After a calibration, all measurements would be referenced to 50Ω , instead of 51Ω . When the line standard is remeasured, the center of the Smith chart is at the current value of **SET Z0** (in this case, 50Ω). Since only one value of offset Z_0 can be selected for the line standard, the value of Z_0 should be a constant value over the frequency range of interest in order to be meaningful.

The location of the reference plane is determined by the selection of **SET REF: THRU** and **SET REF: REFLECT**. By default, the reference plane is set with the thru standard which must have a known insertion phase or electrical length. If a non-zero length thru is specified to have zero delay, the reference plane will be established in the middle of the thru. The reflect standard may be used to set the reference plane instead of the thru provided the phase response (offset delay, reactance values and standard type) of the reflect standard is known and is specified in the calibration kit definition.

Note**Dispersion Effects**

Dispersion occurs when a transmission medium exhibits a variable propagation or phase velocity as a function of frequency. The result of dispersion is a non-linear phase shift versus frequency, which leads to a group delay which is not constant. Fortunately, the TRL calibration technique accounts for dispersive effects of the test fixture up to the calibration plane, provided that:

1. The thru (zero or non-zero length) is defined as having zero electrical length and is used to set the reference plane (**SET REF: THRU**).
2. The transmission lines used as calibration standards have identical dispersion characteristics (i.e., identical height, width and relative dielectric constant).

When a non-zero length thru is used to set the reference plane, it should be defined as having zero length in the TRL standards definition, even though it has physical length. The actual electrical length of the thru standard must then be subtracted from the actual electrical length of each line standard in the TRL calibration kit definition. The device must then be mounted between two short lengths of transmission line so that each length is exactly one-half of the length of the non-zero length thru standard. In this configuration, the measurement will be properly calibrated up to the point of the device.

Power Meter Calibration

The **PWRMTR CAL []** softkey within the correction menu, leads to a series of menus associated with power meter calibration.

An HP-IB-compatible power meter can monitor and correct RF source power to achieve leveled power at the test port. During a power meter calibration, the power meter samples the power at each measurement point across the frequency band of interest. The analyzer then constructs a correction data table to correct the power output of the internal source. The correction table may be saved in an instrument state register with the **SAVE** key.

The correction table may be updated on each sweep (in a leveling application) or during an initial single sweep. In the sample-and-sweep mode the power meter is not needed for subsequent sweeps. The correction table may be read or modified through HP-IB.

Primary Applications

- when you are testing a system with significant frequency response errors (For example, a coupler with significant roll-off, or a long cable with a significant amount of loss.)
- when you are measuring devices that are very sensitive to actual input power for proper operation
- when you require a reference for receiver power calibration

Calibrated Power Level

By setting the analyzer calibrated power to the desired value at the power meter, this power level will be maintained at that port during the entire sweep. First set the source power so that the power at the test device is approximately correct. This reduces residual power errors when only one reading is taken. Refer to **NUMBER OF READINGS** softkey description in Chapter 9, “Key Definitions.” When power meter calibration is on, the annotation PC is displayed. This indicates that the source power is being updated during the sweep. Calibrated power level becomes the active entry if any of the following softkeys are pressed:

PWRMTR CAL [OFF]

EACH SWEEP

ONE SWEEP

POWER (if power meter cal is on)

Regardless of the measurement application, the analyzer’s source can only supply corrected power within the selected power range. If power outside this range is requested, the annotation will change to PC?.

Compatible Sweep Types

Power meter calibration may be used in linear, log, list, CW, and power sweep modes. In power sweep, the power at each point is the true power at the power meter, not the power at the analyzer’s source output.

Loss of Power Meter Calibration Data

The power meter calibration data will be lost by committing any of the following actions:

Turning power off. Turning off the instrument erases the power meter calibration table.

Changing sweep type. If the sweep type is changed (linear, log, list, CW, power) while power meter calibration is on, the calibration data will be lost. However, calibration data is retained if you change the sweep type while power meter calibration is off.

Changing frequency. Power meter calibration data will also be lost if the frequency is changed in log or list mode, but it is retained in linear sweep mode.

Pressing `PRESET`. Presetting the instrument will erase power meter calibration data. If the instrument state has been saved in a register using the `SAVE/RECALL` key, you may recall the instrument state and the data will be restored. Saving the instrument state will not protect the data if the instrument is turned off.

Interpolation in Power Meter Calibration

If the frequency is changed in linear sweep, or the start/stop power is changed in power sweep, then the calibration data is interpolated for the new range.

If calibration power is changed in any of the sweep types, the values in the power setting array are increased or decreased to reflect the new power level. Some accuracy is lost when this occurs.

Power Meter Calibration Modes of Operation

Continuous Sample Mode (Each Sweep)

You can set the analyzer to update the correction table at each point for sweep (as in a leveling application), using the `EACH SWEEP` softkey. In this mode, the analyzer checks the power level at every frequency point each time it sweeps. You can also have more than one sample/correction iteration at each frequency point. (See the `NUMBER OF READINGS` softkey description in Chapter 9.)

While using the continuous sample mode, the power meter must remain connected as shown in Figure 6-54. A power splitter or directional coupler samples the actual power going to the test device and is measured by the power meter. The power meter measurement provides the information necessary to update the correction table via HP-IB.

Continuous correction slows the sweep speed considerably, especially when low power levels are being measured by the power meter. It may take up to 10 seconds per point if the power level is less than -20 dBm. For faster operation, you can use the sample-and-sweep mode. If you use a directional coupler, you must enter the attenuation of the coupled arm with respect to the through arm using the `POWER LOSS` softkey.

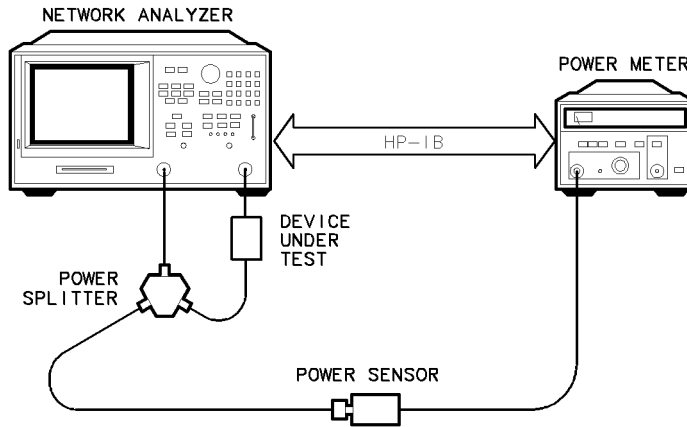

pg680d

Figure 6-54. Test Setup for Continuous Sample Mode

Sample-and-Sweep Mode (One Sweep)

You can use the **ONE SWEEP** softkey to activate the sample-and-sweep mode. This will correct the analyzer output power and update the power meter calibration data table during the initial measurement sweep. In this mode of operation, the analyzer does not require the power meter for subsequent sweeps. You may use a power splitter or directional coupler, or simply connect the power sensor directly to the analyzer to measure the power for the initial sweep prior to connecting and measuring the test device (see Figure 6-55).

The speed of the calibration will be slow while power meter readings are taken (see Table 6-6). However, once the sample sweep is finished, subsequent sweeps are power-corrected using the data table, and sweep speed increases significantly. Once the initial sweep is taken, sample-and-sweep correction is much faster than continuous sample correction.

If the calibrated power level is changed after the initial measurement sweep is done, the entire correction table is increased or decreased by that amount and the annotation PC_o (indicating power calibration offset) appears on the display. The resulting power will no longer be as accurate as the original calibration.

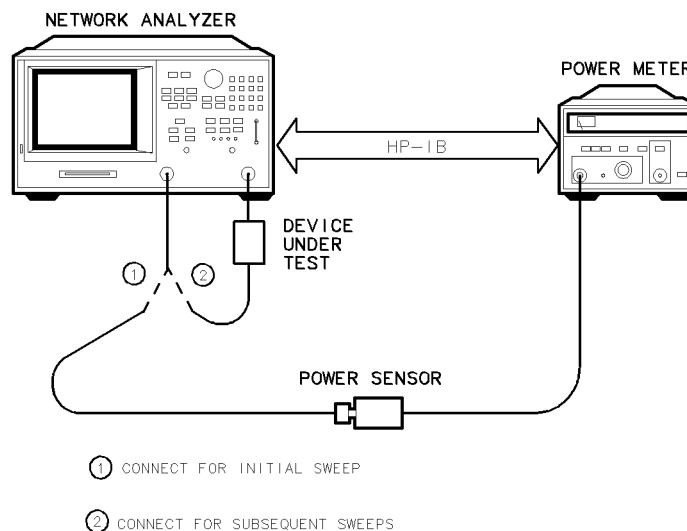

pg698d

Figure 6-55. Test Setup for Sample-and-Sweep Mode

Power Loss Correction List

If a directional coupler or power splitter is used to sample the RF power output of the analyzer, the RF signal going to the power meter may be different than that going to the test device. A directional coupler will attenuate the RF signal by its specified coupling factor. The difference in attenuation between the through arm and the coupled arm (coupling factor) must be entered using the loss/sensor list menu. Non-linearities in either the directional coupler or power splitter can be corrected in the same way.

Power loss information is entered in much the same way as limit line parameters. Up to 12 segments may be entered, each with a different attenuation value. The entered data will not be lost if the instrument's power is cycled.

Power Sensor Calibration Factor List

Two power sensor calibration data lists can be created in the analyzer. No single power sensor covers the entire frequency range of the analyzer; therefore the calibration data for two different power sensors must be available. The entered data will not be lost if the instrument's power is cycled.

Speed and Accuracy

The speed and accuracy of a power meter calibration vary depending on the test setup and the measurement parameters. For example, number of points, number of readings, if the power is less than -20 dBm, continuous versus sample and sweep mode. Accuracy is improved if you set the source power such that it is approximately correct at the measurement port. Power meter calibration should then be turned on. With number of readings = 2, very accurate measurements are achieved.

Table 6-6 shows typical sweep speed and power accuracy. The times given apply only to the test setup for continuous correction or for the first sweep of sample-and-sweep correction.

The typical values given in Table 6-6 were derived under the following conditions:

Test Equipment Used

- HP 8753D network analyzer
- HP 436A power meter
- HP 8485A power sensor

Stimulus Parameters

The time required to perform a power meter calibration depends on the source power and number of points tested. The parameters used to derive the typical values in Table 6-6 are as follows:

- number of points: 51, 100 kHz to 3 GHz
- test port power: equal to calibration power

Sweep time is linearly proportional to the number of points measured. For example, a sweep taking 49 seconds at 51 points will take approximately 98 seconds if 101 points are measured.

Table 6-6.
Characteristic Power Meter Calibration Sweep Speed and Accuracy

Power Desired at Test Port (dBm)	Number of Readings	Sweep Time (seconds) ¹	Characteristic Accuracy (dB) ²
+5	1	33	±0.7
	2	64	±0.2
	3	95	±0.1
-15	1	48	±0.7
	2	92	±0.2
	3	123	±0.1
-30	1	194	±0.7
	2	360	±0.2
	3	447	±0.1

1 Sweep speed applies to every sweep in continuous correction mode, and to the first sweep in sample-and-sweep mode. Subsequent sweeps in sample-and-sweep mode will be much faster.

2 The accuracy values were derived by combining the accuracy of the power meter and linearity of the analyzer's internal source, as well as the mismatch uncertainty associated with the power sensor.

Notes On Accuracy

The accuracy values in Table 6-6 were derived by combining the accuracy of the power meter and linearity of the analyzer's internal source, as well as the mismatch uncertainty associated with the test set and the power sensor.

Power meter calibration measures the source power output (at the measurement port) at a single stimulus point, and compares it to the calibrated power you selected. If the two values are different, power meter calibration changes the source output power by the difference. This process is repeated at every stimulus point. The accuracy of the result depends on the amount of correction required. If the selected number of readings = 1, the final measurement accuracy is significantly affected by a large power change. However, if the selected number of readings is >1, the power change on the second or third reading is much smaller: thus accuracy is much better.

Set source power approximately correct at the measurement port, then activate power meter calibration. This method can significantly increase the accuracy of the measurement when the selected number of readings = 1. Smaller accuracy improvements occur with a higher number of readings. Remember that mismatch errors affect accuracy as well.

Note Power meter correction applies to one port only; the other port is not corrected.

Alternate and Chop Sweep Modes

You can select the **ALTERNATE A and B** or **CHOP A and B** softkey within the Correction More menu to activate either one or the other sweep modes. For information about sweep types, refer to “Sweep Type Menu,” located earlier in this chapter.

Alternate

ALTERNATE A and B measures only one input per frequency sweep, in order to reduce unwanted signals, such as crosstalk from sampler A to B when measuring B/R. Thus, this mode optimizes the dynamic range for all four S-parameter measurements.

The disadvantages of this mode are associated with simultaneous transmission/reflection measurements or full two-port calibrations: this mode takes twice as long as the chop mode to make these measurements.

Chop

CHOP A and B is the default measurement mode. This mode measures both inputs A and B during each sweep. Thus, if each channel is measuring a different parameter and both channels are displayed, the chop mode offers the fastest measurement time. This is the preferred measurement mode for full two-port calibrations because both inputs remain active.

The disadvantage of this mode is that in measurements of high rejection devices greater than 85 dB, such as filters with a low-loss passband, maximum dynamic range may not be achieved.

Figure 6-56 shows the *alternate* sweep mode (bold trace) overlaying the *chop* sweep mode in a band-pass filter measurement. Note the difference in the crosstalk levels between the two modes.

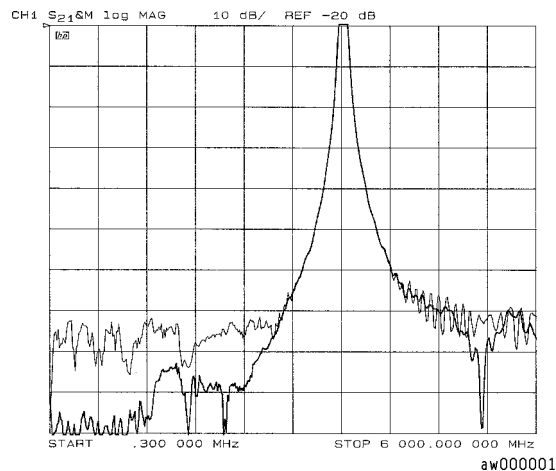

Figure 6-56. Alternate and Chop Sweeps Overlaid

Calibrating for Non-Insertable Devices

A test device having the same sex connector on both the input and output cannot be connected directly into a transmission test configuration. Therefore, the device is considered to be *noninsertable*, and one of the following calibration methods must be performed. For information on performing measurement calibrations, refer to Chapter 5, “Optimizing Measurement Results.”

Adapter Removal

The adapter removal technique provides a means to accurately measure the noninsertable device. For each port, a separate 2-port error correction needs to be performed to create a calibration set. The adapter removal algorithm uses the resultant data from the two calibration sets and the nominal electrical length of the adapter to compute the adapters actual S-parameters. This data is then used to generate a separate third cal set in which the forward and reverse match and tracking terms are as if Port 1 and Port 2 could be connected. This is possible because the actual S-parameters of the adapter are measured with great accuracy, thus allowing the effects of the adapter to be completely removed when the third cal set is generated. See Chapter 5.

Matched Adapters

With this method, you use two precision matched adapters which are “equal.” To be equal, the adapters must have the same match, Z_0 , insertion loss, and electrical delay.

Modify the Cal Kit Thru Definition

With this method it is only necessary to use one adapter. The calibration kit thru definition is modified to compensate for the adapter and then saved as a user kit. However, the electrical delay of the adapter must first be found.

Using the Instrument State Functions

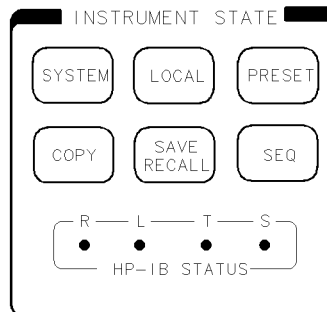

pg6119d

Figure 6-57. Instrument State Function Block

The instrument state function block keys provide control of channel-independent system functions. The following keys are described in this chapter:

- **SYSTEM**: Limit lines and limit testing, time domain operation, and instrument modes.
- **LOCAL**: HP-IB controller modes, instrument addresses, and the use of the parallel port.
- **SEQ**: Test sequencing.

Information on the remaining instrument state keys can be found in the following chapters:

- **PRESET**: Chapter 12, "Preset State and Memory Allocation"
- **COPY**: Chapter 4, "Printing, Plotting, and Saving Measurement Results"
- **SAVE/RECALL**: Chapter 4, "Printing, Plotting, and Saving Measurement Results"

HP-IB Menu

This section contains information on the following topics:

- local key
- HP-IB controller modes
- instrument addresses
- using the parallel port

LOCAL Key

This key allows you to return the analyzer to local (front panel) operation from remote (computer controlled) operation. This key will also abort a test sequence or hardcopy print/plot. In this local mode, with a controller still connected on HP-IB, you can operate the analyzer manually (locally) from the front panel. This is the only front panel key that is not disabled when the analyzer is remotely controlled over HP-IB by a computer. The exception to this is when local lockout is in effect: this is a remote command that disables the **LOCAL** key, making it difficult to interfere with the analyzer while it is under computer control.

In addition, the **LOCAL** key provides access to the HP-IB menu, where you can set the controller mode, and to the address menu, where you can enter the HP-IB addresses of peripheral devices and select plotter/printer ports. You can also set the mode of the parallel port here.

The HP-IB menu consists of the following softkeys:

- **SYSTEM CONTROLLER**
- **TALKER/LISTENER**
- **USE PASS CONTROL**
- **SET ADDRESS**
- **PARALLEL []**
- **HP-IB DIAG on OFF**
- **DISK UNIT NUMBER**
- **VOLUME NUMBER**

The analyzer is factory-equipped with a remote programming interface using the Hewlett-Packard Interface Bus (HP-IB). This enables communication between the analyzer and a controlling computer as well as other peripheral devices. This menu indicates the present HP-IB controller mode of the analyzer. Three HP-IB modes are possible: system controller, talker/listener, and pass control.

HP-IB STATUS Indicators

When the analyzer is connected to other instruments over HP-IB, the HP-IB STATUS indicators in the instrument state function block light up to display the current status of the analyzer.

R = remote operation

L = listen mode

T = talk mode

S = service request (SRQ) asserted by the analyzer

System Controller Mode

The **SYSTEM CONTROLLER** softkey activates the system controller mode. When in this mode, the analyzer can use HP-IB to control compatible peripherals, without the use of an external computer. It can output measurement results directly to a compatible printer or plotter, store instrument states using a compatible disk drive, or control a power meter for performing service routines. The power meter calibration function requires system controller or pass control mode.

Talker/Listener Mode

The **TALKER/LISTENER** softkey activates the talker/listener mode, which is the mode of operation most often used. In this mode, a computer controller communicates with the analyzer and other compatible peripherals over the bus. The computer sends commands or instructions to and receives data from the analyzer. All of the capabilities available from the analyzer front panel can be used in this remote operation mode, except for control of the power line switch and some internal tests.

Pass Control Mode

The **USE PASS CONTROL** softkey activates the third mode of HP-IB operation: the pass control mode. In an automated system with a computer controller, the controller can pass control of the bus to the analyzer on request from the analyzer. The analyzer is then the controller of the peripherals, and can direct them to plot, print, or store without going through the computer. When the peripheral operation is complete, control is passed back to the computer. Only one controller can be active at a time. The computer remains the system controller, and can regain control at any time.

Preset does not affect the selected controller mode, but cycling the power returns the analyzer to talker/listener mode.

Information on compatible peripherals is provided in Chapter 11, "Compatible Peripherals."

Address Menu

This menu can be accessed by pressing the **SET ADDRESS** softkey within the HP-IB menu.

In communications through the Hewlett-Packard Interface Bus (HP-IB), each instrument on the bus is identified by an HP-IB address. This decimal-based address code must be different for each instrument on the bus.

This menu lets you set the HP-IB address of the analyzer, and enter the addresses of peripheral devices so that the analyzer can communicate with them.

Most of the HP-IB addresses are set at the factory and need not be modified for normal system operation. The standard factory-set addresses for instruments that may be part of the system are as follows:

Instrument	HP-IB Address (decimal)
Analyzer	16
Plotter	05
Printer	01
External Disk Drive	00
Controller	21
Power Meter	13

The address displayed in this menu for each peripheral device must match the address set on the device itself. The analyzer does not have an HP-IB switch: its address is set only from the front panel.

These addresses are stored in non-volatile memory and are not affected by preset or by cycling the power.

Using the Parallel Port

The instrument's parallel port can be used in two different modes. By pressing **(LOCAL)** and then toggling the **PARALLEL []** softkey, you can select either the **[COPY]** mode or the **[GPIO]** mode.

The Copy Mode

The copy mode allows the parallel port to be connected to a printer or plotter for the outputting of test results. To use the parallel port for printing or plotting, you must do the following:

1. Press **(LOCAL) SET ADDRESSES**.
2. Select either **PLOTTER PORT** or **PRINTER PORT**.
3. Select **PARALLEL** so that copy is underlined.

The GPIO Mode

The GPIO mode turns the parallel port into a "general purpose input/output" port.

In this mode the port can be connected to test fixtures, power supplies, and other peripheral equipment that might be used to interact with the analyzer during measurements. This mode is exclusively used in test sequencing.

The System Menu

The **SYSTEM** key provides access to the system menu. This menu leads to additional menus which control various aspects of the analyzer system. The following softkeys are located within the system menu:

- **SET CLOCK** allows you to produce time stamps on plots and print-outs.
- **LIMIT MENU** provides access to the limits menu.
- **TRANSFORM MENU** (Option 010 Only) provides access to the transform menu.
- **HARMONIC MEAS** (Option 002 Only) provides access to the harmonic mode menu.
- **INSTRUMENT MODE** provides access to the instrument mode menu.
- **SERVICE MENU** provides access to the service menu (see the *HP 8753D Network Analyzer Service Guide*).

The Limits Menu

This menu can be accessed by pressing **LIMIT MENU** softkey within the system menu.

You can have limit lines drawn on the display to represent upper and lower limits or device specifications with which to compare the test device. Limits are defined in segments, where each segment is a portion of the stimulus span. Each limit segment has an upper and a lower starting limit value. Three types of segments are available: flat line, sloping line, and single point.

Limits can be defined independently for the two channels, up to 22 segments for each channel. These can be in any combination of the three limit types.

Limit testing compares the measured data with the defined limits, and provides pass or fail information for each measured data point. An out-of-limit test condition is indicated in five ways: with a FAIL message on the screen, with a beep, by changing the color of the failing portions of a trace, with an asterisk in tabular listings of data, and with a bit in the HP-IB event status register B. (The analyzer also has a BNC rear panel output that includes this status, but is only valid for a single channel measurement.)

Note The limit test output has three selectable modes. For more information, refer to Chapter 2, "Making Measurements."

Limit lines and limit testing can be used simultaneously or independently. If limit lines are on and limit testing is off, the limit lines are shown on the display for visual comparison and adjustment of the measurement trace. However, no pass/fail information is provided. If limit testing is on and limit lines are off, the specified limits are still valid and the pass/fail status is indicated even though the limit lines are not shown on the display.

Limits are entered in tabular form. Limit lines and limit testing can be either on or off while limits are defined. As new limits are entered, the tabular columns on the display are updated, and the limit lines (if on) are modified to the new definitions. The complete limit set can be offset in either stimulus or amplitude value.

Limits are checked only at the actual measured data points. It is possible for a device to be out of specification without a limit test failure indication if the point density is insufficient. Be sure to specify a high enough number of measurement points in the stimulus menu.

Limit lines are displayed only on Cartesian formats. In polar and Smith chart formats, limit testing of one value is available: the value tested depends on the marker mode and is the magnitude or the first value in a complex pair. The message NO LIMIT LINES DISPLAYED is shown on the display in polar and Smith chart formats.

The list values feature in the copy menu provides tabular listings to the display or a printer for every measured stimulus value. These include limit line or limit test information if these functions are activated. If limit testing is on, an asterisk is listed next to any measured value that is out of limits. If limit lines are on, and other listed data allows sufficient space, the upper limit and lower limit are listed, together with the margin by which the device data passes or fails the nearest limit.

If limit lines are on, they are plotted with the data on a plot. If limit testing is on, the PASS or FAIL message is plotted, and the failing portions of the trace that are a different color on the display are also a different color on the plot. If limits are specified, they are saved in memory with an instrument state.

Edit Limits Menu

This menu allows you to specify limits for limit lines or limit testing, and presents a table of limit values on the display. Limits are defined in segments. Each segment is a portion of the stimulus span. Up to 22 limit segments can be specified for each channel. The limit segments do not have to be entered in any particular order: the analyzer automatically sorts them and lists them on the display in increasing order of start stimulus value.

For each segment, the table lists the segment number, the starting stimulus value, upper limit, lower limit, and limit type. The ending stimulus value is the start value of the next segment, or a segment can be terminated with a single point segment. You can enter limit values as upper and lower limits or delta limits and middle value. As new limit segments are defined, the tabular listing is updated. If limit lines are switched on, they are shown on the display.

If no limits have been defined, the table of limit values shows the notation EMPTY. Limit segments are added to the table using the **ADD** softkey or edited with the **EDIT** softkey, as previously described. The last segment on the list is followed by the notation END.

Edit Segment Menu

This menu sets the values of the individual limit segments. The segment to be modified, or a default segment, is selected in the edit limits menu. The stimulus value can be set with the controls in the entry block or with a marker (the marker is activated automatically when this menu is presented). The limit values can be defined as upper and lower limits, or delta limits and middle value. Both an upper limit and a lower limit (or delta limits) must be defined: if only one limit is required for a particular measurement, force the other out of range (for example +500 dB or -500 dB).

As new values are entered, the tabular listing of limit values is updated.

Segments do not have to be listed in any particular order: the analyzer sorts them automatically in increasing order of start stimulus value when the **DONE** key in the edit limits menu is pressed. However, the easiest way to enter a set of limits is to start with the lowest stimulus value and define the segments from left to right of the display, with limit lines turned on as a visual check.

Phase limit values can be specified between +500° and -500°. Limit values above +180° and below -180° are mapped into the range of -180° to +180° to correspond with the range of phase data values.

Offset Limits Menu

This menu allows the complete limit set to be offset in either stimulus value or amplitude value. This is useful for changing the limits to correspond with a change in the test setup, or for device specifications that differ in stimulus or amplitude. It can also be used to move the limit lines away from the data trace temporarily for visual examination of trace detail.

Knowing the Instrument Modes

There are five major instrument modes of the analyzer:

- network analyzer mode
- external source mode
- tuned receiver mode
- frequency offset operation
- harmonic mode operation (Option 002)

The instrument mode menu can be accessed by pressing **(SYSTEM) INSTRUMENT MODE**. This menu contains the following softkeys:

- NETWORK ANALYZER
- EXT SOURCE AUTO
- EXT SOURCE MANUAL
- TUNED RECEIVER
- FREQ OFFS MENU

Network Analyzer Mode

This is the standard mode of operation for the analyzer, and is active after you press **(PRESET)** or switch on the AC power.

Pressing **(SYSTEM) INSTRUMENT MODE NETWORK ANALYZER** returns the analyzer to the “normal” network analyzer operating mode.

This mode uses the analyzer’s internal source.

External Source Mode

This mode allows the analyzer to phase lock to an external CW signal. External source mode is best used for unknown signals, or for signals that drift. If a synthesized external source is used, the tuned receiver mode is recommended because it is faster.

Primary Applications

External source mode is useful in several applications:

- when your test device is a mixer or other frequency translation device
- in automated test applications where a source is already connected to the system, and you do not want to switch between the system source and the analyzer’s internal source.

Typical Test Setup

Figure 6-58 shows a typical test setup using the external source mode. The same test setup is applicable for either manual or automatic external source mode operation.

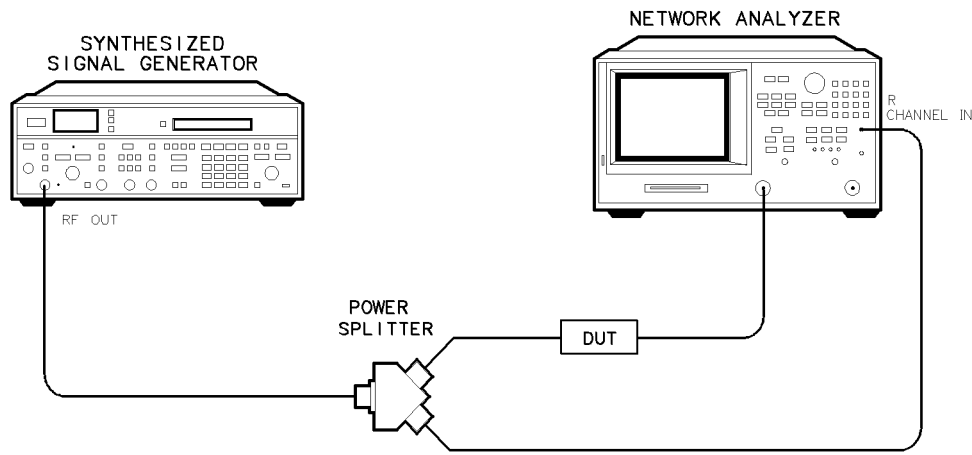

pg6152d

Figure 6-58. Typical Setup for the External Source Mode

External Source Mode In-Depth Description

You may use the external source in automatic or manual mode. External source mode phase locks the analyzer to an external CW signal.

Note The external source mode works only in CW time sweep.

External Source Auto. If you press **(SYSTEM) INSTRUMENT MODE EXT SOURCE AUTO** the analyzer turns on the external source auto mode. You should observe the following points when using this operation mode:

- The auto mode has a wider capture range than the manual mode.
- The manual mode is faster than the auto mode.
- The auto mode searches for the incoming CW signal.
- The capture range is typically 10% of the selected CW frequency.
- This feature works only in CW time sweep type.
- The incoming signal should not have large spurs or sidebands, as the analyzer may phase lock on a spur or not phase lock at all.

The frequency the instrument has locked onto is shown on the analyzer, and is also available via HP-IB.

External Source Manual. If you press **(SYSTEM) INSTRUMENT MODE EXT SOURCE MANUAL** the analyzer activates the external source manual mode. You should observe the following points when using this operation mode:

- The manual mode has a smaller capture range than the auto mode.
- The manual mode is much faster than auto mode.
- This feature works only in CW time sweep type.
- The incoming signal should not have large spurs or sidebands, as the analyzer may phase lock on a spur or not phase lock at all.

- The frequency of the incoming signal should be within -0.5 to $+5.0$ MHz of the selected frequency or the analyzer will not be able to phase lock to it.

CW Frequency Range in External Source Mode. 300 kHz to 3 GHz (6 GHz for Option 006)

Compatible Sweep Types. The external source mode will only function in CW time sweep. If the instrument is in any other sweep type when external source is activated, the warning message CHANGED TO CW TIME MODE will appear on the display.

External Source Requirements. The external source mode has spectral purity and power input requirements, which are described in Chapter 7, “Specifications and Measurement Uncertainties.”

Input Channel: R

Capture Range. In either automatic or manual mode, you can enter the frequency of the external CW signal using the CW FREQ softkey (located under the Stimulus (MENU) key). The actual signal must be within a certain frequency capture range as shown in Table 6-7.

Table 6-7. External Source Capture Ranges

Mode	CW Frequency	Capture Range
Automatic	≤ 50 MHz	± 5 MHz of nominal CW frequency
	> 50 MHz	$\pm 10\%$ of nominal CW frequency
Manual	All	-0.5 to $+5$ MHz of nominal CW frequency

If the incoming signal is not within the capture range, the analyzer will not phase lock correctly.

Locking onto a signal with a frequency modulation component. Although the analyzer may phase-lock onto a signal that has FM, it may not accurately show the signal’s amplitude. The accuracy of such measurements depends greatly on the IF bandwidth you choose. Use the widest IF bandwidth available (3 kHz) if this problem occurs.

Tuned Receiver Mode

If you press (SYSTEM) INSTRUMENT MODE TUNED RECEIVER the analyzer receiver operates independently of any signal source.

The following features and limitations apply to the tuned receiver mode:

- It is a fully synthesized receiver; it does not phase-lock to any source.
- It functions in all sweep types.
- It requires a synthesized CW source whose timebase is input to the analyzer’s external frequency reference.

For more information on using the tuned receiver mode, refer to Chapter 2, “Making Measurements.”

Frequency Offset Menu

If you press **(SYSTEM) INSTRUMENT MODE FREQ OFFS MENU**, the analyzer allows phase-locked operation with a frequency offset between the internal source and receiver. This feature is used in swept RF mixer measurements and has an upper frequency limit equal to that of the analyzer being used.

This feature allows you to set the RF source to a fixed offset frequency above or below the receiver (as required in a mixer test, using a swept RF/IF and fixed LO). Then you can input a signal to a device over one frequency range and view its response over a different frequency range. The maximum delay between the RF source and the R input is 0.3 microseconds. The analyzer will show a signal that is a composite of the desired RF signal, image response, and spurious signals.

You can use the frequency offset in any sweep type in network analyzer mode. The two user-defined variables in this mode are receiver frequency and offset frequency (LO). The analyzer automatically sets the source frequency equal to $IF + LO$ or $IF - LO$.

Mixer measurements and frequency offset mode applications are explained in application note 8753-2, "RF Component Measurements Mixer Measurements using the HP 8753B Network Analyzer," HP part number 5956-4362. This application note was written for the HP 8753B but also applies to the HP 8753D. Also see product note 8753-2A, HP part number 5952-2771.

Primary Applications

Frequency offset mode is useful for the following types of measurements on frequency-translating device:

- conversion loss
- conversion compression
- amplitude and phase tracking

Typical Test Setup

Figure 6-59 shows a typical test setup using frequency offset mode. Instructions are provided in Chapter 3, "Making Mixer Measurements." The attenuators shown reduce mismatch uncertainties. The low pass filter keeps unwanted mixing products out of the sampler.

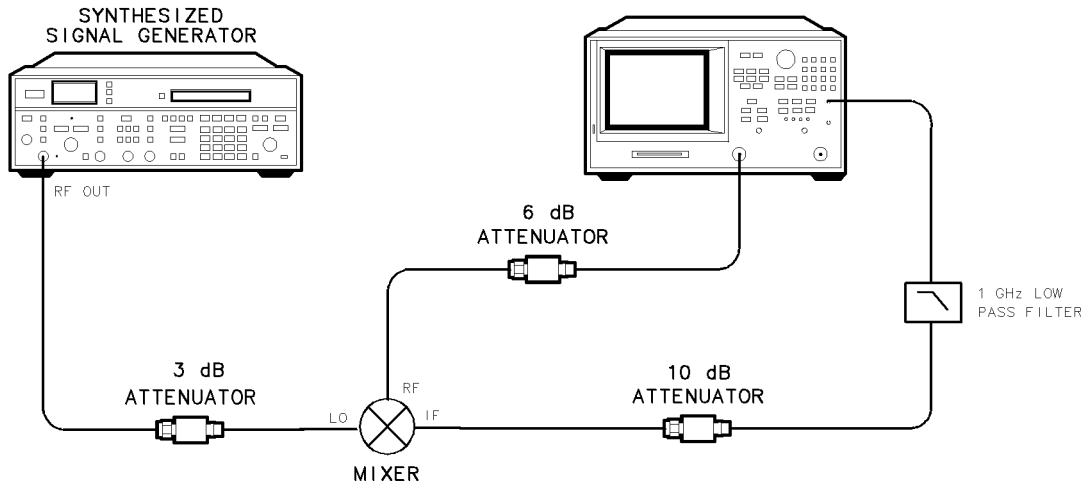

pg6113d

Figure 6-59. Typical Test Setup for a Frequency Offset Measurement

Frequency Offset In-Depth Description

The source and receiver operate at two different frequencies in frequency offset operation. The difference between the source and receiver frequencies is the LO frequency that you specify.

The two user-defined variables in frequency offset are the receiver frequency, and the offset (LO) frequency. The source frequency is automatically set by the instrument and equals receiver frequency $IF + LO$ or $IF - LO$.

The Receiver Frequency. You can choose a CW value or start and stop values for the receiver frequency. The stimulus values, which appear on the analyzer display, will affect only the receiver.

The Offset Frequency (LO). This frequency value is the difference between the source and receiver frequencies.

Note The analyzer's source locks to the receiver \pm the LO frequency, regardless of the offset value you selected.

Once the source is phase-locked and sweeping, the analyzer's source frequency is not known precisely. As the LO frequency changes, the source tracks it to maintain the receiver start/stop or CW frequency that you requested.

Frequency Hierarchy. The source frequency can be greater than or less than the LO frequency. That is, the analyzer can measure either the lower or upper of the two IF mixing products when it is in the frequency offset mode.

Frequency Ranges. Receiver frequency range: 300 kHz to 3 GHz (or 6 GHz with Option 006)

Compatible Instrument Modes and Sweep Types. Frequency offset is compatible with all sweep types in the network analyzer mode.

Receiver and Source Requirements. Refer to Chapter 7, “Specifications and Measurement Uncertainties.”

IF Input: R always; and port 1 or port 2 for a ratio measurement.

Display Annotations. The analyzer shows the annotation of s when the frequency offset mode is on. The annotation of $?$ indicates that the source frequency is approximately 10 MHz away from the sum of the IF and LO frequencies that you requested. This is most likely caused by the LO frequency being outside the -1 to $+5$ MHz accuracy requirement.

Error Message. If you connect your test device before you switch on the frequency offset function, the error message PHASE LOCK CAL FAILED appears on the screen. This is normal, and will disappear when you press the **FREQ OFFS on OFF** softkey.

Spurious Signal Passband Frequencies. Unwanted mixing products (or spurious LO signals) at specific frequencies can cause measurement inaccuracy, because of the characteristics of a sampler. These specific frequencies can be calculated. You can reduce unwanted mixing products going to the sampler by inserting a low pass filter at your test device’s IF output.

Harmonic Operation (Option 002 only)

The analyzer's harmonic menu can be accessed by pressing **SYSTEM** **HARMONIC MEAS**.

The harmonic measurement mode allows you to measure the second or third harmonic as the analyzer's source sweeps fundamental frequencies above 16 MHz. The analyzer can make harmonic measurements in any sweep type.

Typical Test Setup

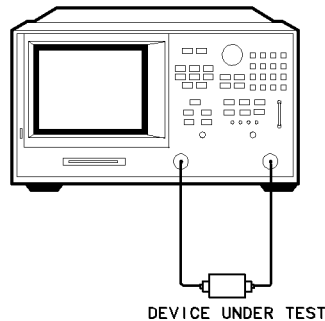

pg6110d

Figure 6-60. Typical Harmonic Mode Test Setup

Single-Channel Operation

You can view the second or third harmonic alone by using only one of the analyzer's two channels.

Dual-Channel Operation

To make the following types of measurements, uncouple channels 1 and 2, and switch on dual channel.

- The analyzer measures the fundamental on one channel while measuring the second or third harmonic on the other channel.
- The analyzer measures the second harmonic on one channel while measuring the third harmonic on the other channel.
- Using the **COUPLE PWR ON off** feature, the analyzer measures the fundamental on channel 1 while measuring the second or third harmonic in dBc on channel 2.
- Using the **COUPLE PWR ON off** feature, the analyzer couples power between channels 1 and 2. This is useful when you are using the D2/D1 to D2 feature because you can change fundamental power and see the resultant change in the harmonic power.

The analyzer shows the fundamental frequency value on the display. However, a marker in the active entry area shows the harmonic frequency in addition to the fundamental. If you use the harmonic mode, the annotation H=2 or H=3 appears on the left-hand side of the display. The measured harmonic cannot not exceed the frequency limitations of the network analyzer's receiver.

Coupling Power Between Channels 1 and 2

COUPLE PWR ON off is intended to be used with the **D2/D1 toD2 on OFF** softkey. You can use the D2/D1 to D2 function in harmonic measurements, where the analyzer shows the fundamental on channel 1 and the harmonic on channel 2. D2/D1 to D2 ratios the two,

showing the fundamental and the relative power of the measured harmonic in dBc. You must uncouple channels 1 and 2 for this measurement, using the **COUPLED CHAN ON off** softkey set to OFF to allow alternating sweeps.

After uncoupling channels 1 and 2, you may want to change the fundamental power and see the resultant change in relative harmonic power (in dBc). **COUPLE PWR ON off** allows you to change the power of both channels simultaneously, even though they are uncoupled in all other respects.

Frequency Range

The frequency range is determined by the upper frequency range of the instrument or system (3 or 6 GHz) and by the harmonic being displayed. The 6 GHz operation requires an HP 8753D Option 006. Table 6-8 shows the highest fundamental frequency for maximum frequency and harmonic mode.

Table 6-8. Maximum Fundamental Frequency using Harmonic Mode

Harmonic Measured	Maximum Fundamental Frequency	
	HP 8753D	HP 8753D (Option 006)
2nd Harmonic	1.5 GHz	3 GHz
3rd Harmonic	1.0 GHz	2.0 GHz

Accuracy and input power

Refer to Chapter 7, “Specifications and Measurement Uncertainties.” The maximum recommended input power and maximum recommended source power are related specifications.

Using power levels greater than the recommended values, you may cause undesired harmonics in the source and receiver. The recommended power levels ensure that these harmonics are less than 45 dBc. Use test port power to limit the input power to your test device.

Time Domain Operation (Option 010)

With Option 010, the analyzer can transform frequency domain data to the time domain or time domain data to the frequency domain.

In normal operation, the analyzer measures the characteristics of a test device as a function of frequency. Using a mathematical technique (the inverse Fourier transform), the analyzer transforms frequency domain information into the time domain, with time as the horizontal display axis. Response values (measured on the vertical axis) now appear separated in time or distance, providing valuable insight into the behavior of the test device beyond simple frequency characteristics.

Note An HP 8753D can be ordered with Option 010, or the option can be added at a later date using the HP 85019B time domain retrofit kit.

The transform used by the analyzer resembles time domain reflectometry (TDR) measurements. TDR measurements, however, are made by launching an impulse or step into the test device and observing the response in time with a receiver similar to an oscilloscope. In contrast, the analyzer makes swept frequency response measurements, and mathematically transforms the data into a TDR-like display.

The Transform Menu

The analyzer's transform menu can be accessed by pressing **SYSTEM** **TRANSFORM MENU**. This menu consists of the following softkeys:

- **TRANSFORM ON off**
- **SET FREQ LOW PASS**
- **LOW PASS IMPULSE**
- **LOW PASS STEP**
- **BANDPASS**
- **WINDOW**
- **SPECIFY GATE**

The analyzer has three frequency-to-time transform modes:

Time domain bandpass mode is designed to measure band-limited devices and is the easiest mode to use. This mode simulates the time domain response of an impulse input.

Time domain low pass step mode simulates the time domain response of a step input. As in a traditional TDR measurement, the distance to the discontinuity in the test device, and the type of discontinuity (resistive, capacitive, inductive) can be determined.

Time domain low pass impulse mode simulates the time domain response of an impulse input (like the bandpass mode). Both low pass modes yield better time domain resolution for a given frequency span than does the bandpass mode. In addition, when using the low pass modes, you can determine the type of discontinuity. However, these modes have certain limitations that are defined in "Time domain low pass," later in this section.

The analyzer has one time-to-frequency transform mode:

Forward transform mode transforms CW signals measured over time into the frequency domain, to measure the spectral content of a signal. This mode is known as the CW time mode.

In addition to these transform modes, this section discusses special transform concepts such as masking, windowing, and gating.

General Theory

The relationship between the frequency domain response and the time domain response of the analyzer is defined by the Fourier transform. Because of this transform, it is possible to measure, in the frequency domain, the response of a linear test device and mathematically calculate the inverse Fourier transform of the data to find the time domain response. The analyzer's internal computer makes this calculation using the chirp-Z Fourier transform technique. The resulting measurement is the fully error-corrected time domain reflection or transmission response of the test device, displayed in near real-time.

Figure 6-61 illustrates the frequency and time domain reflection responses of a test device. The frequency domain reflection measurement is the composite of all the signals reflected by the discontinuities present in the test device over the measured frequency range.

Note In this section, all points of reflection are referred to as discontinuities.

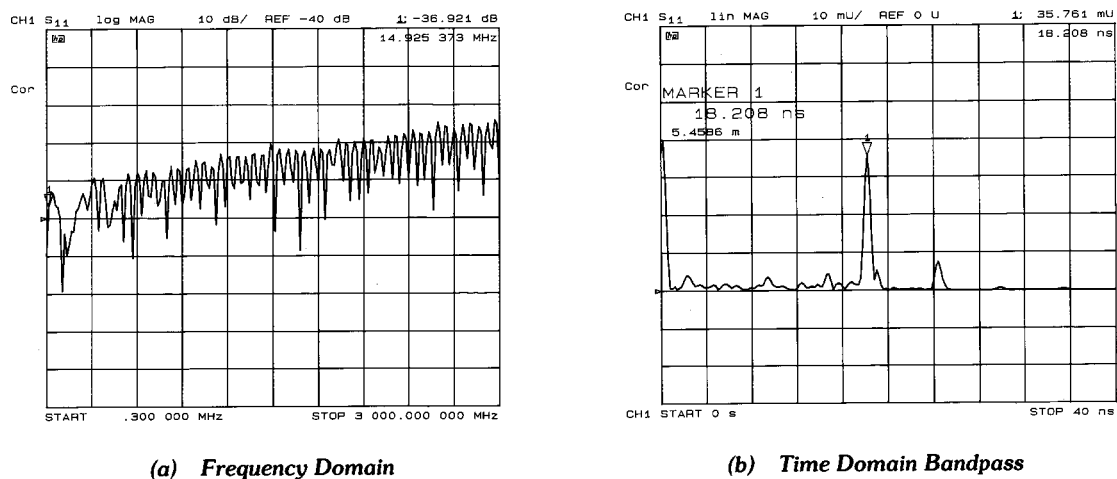

pg6198_c

Figure 6-61. Device Frequency Domain and Time Domain Reflection Responses

The time domain measurement shows the effect of each discontinuity as a function of time (or distance), and shows that the test device response consists of three separate impedance changes. The second discontinuity has a reflection coefficient magnitude of 0.035 (i.e. 3.5% of the incident signal is reflected). Marker 1 on the time domain trace shows the elapsed time from the reference plane (where the calibration standards are connected) to the discontinuity and back: 18.2 nanoseconds. The distance shown (5.45 meters) is based on the assumption that the signal travels at the speed of light. The signal travels slower than the speed of light in most media (e.g. coax cables). This slower velocity (relative to light) can be compensated for by adjusting the analyzer relative velocity factor. This procedure is described later in this section under “Time domain bandpass.”

Time Domain Bandpass

This mode is called bandpass because it works with band-limited devices. Traditional TDR requires that the test device be able to operate down to dc. Using bandpass mode, there are no restrictions on the measurement frequency range. Bandpass mode characterizes the test device impulse response.

Adjusting the Relative Velocity Factor

A marker provides both the time (x2) and the electrical length (x2) to a discontinuity. To determine the physical length, rather than the electrical length, change the velocity factor to that of the medium under test:

1. Press **CAL** **MORE** **VELOCITY FACTOR**.
2. Enter a velocity factor between 0 and 1.0 (1.0 corresponds to the speed of light in a vacuum). Most cables have a velocity factor of 0.66 (polyethylene dielectrics) or 0.70 (teflon dielectrics).

Note To cause the markers to read the actual one-way distance to a discontinuity, rather than the two-way distance, enter one-half the actual velocity factor.

Reflection Measurements Using Bandpass Mode

The bandpass mode can transform reflection measurements to the time domain. Figure 6-62a shows a typical frequency response reflection measurement of two sections of cable. Figure 6-62b shows the same two sections of cable in the time domain using the bandpass mode.

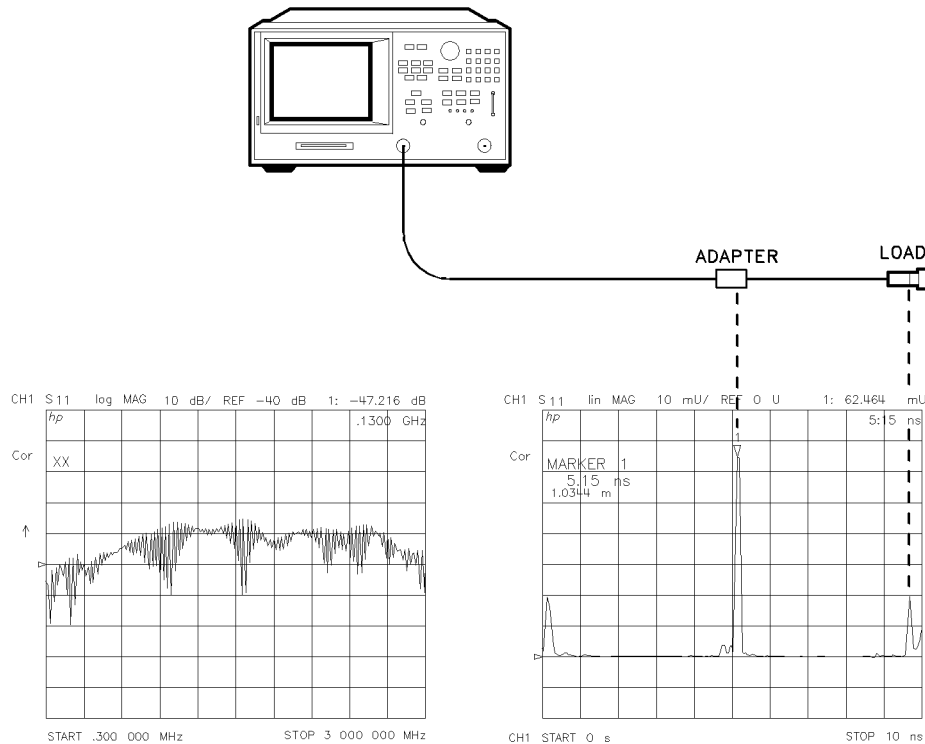

pg6120d

Figure 6-62. A Reflection Measurement of Two Cables

The ripples in reflection coefficient versus frequency in the frequency domain measurement are caused by the reflections at each connector “beating” against each other.

One at a time, loosen the connectors at each end of the cable and observe the response in both the frequency domain and the time domain. The frequency domain ripples increase as each connector is loosened, corresponding to a larger reflection adding in and out of phase with the other reflections. The time domain responses increase as you loosen the connector that corresponds to each response.

Interpreting the bandpass reflection response horizontal axis. In bandpass reflection measurements, the horizontal axis represents the time it takes for an impulse launched at the test port to reach a discontinuity and return to the test port (the two-way travel time). In Figure 6-61, each connector is a discontinuity.

Interpreting the bandpass reflection response vertical axis. The quantity displayed on the vertical axis depends on the selected format. The common formats are listed in Table 6-9. The default format is LOG MAG (logarithmic magnitude), which displays the return loss in decibels (dB). LIN MAG (linear magnitude) is a format that displays the response as reflection coefficient (ρ). This can be thought of as an average reflection coefficient of the discontinuity over the frequency range of the measurement. Use the REAL format only in low pass mode.

Table 6-9. Time Domain Reflection Formats

Format	Parameter
LIN MAG	Reflection Coefficient (unitless) ($0 < \rho < 1$)
REAL	Reflection Coefficient (unitless) ($-1 < \rho < 1$)
LOG MAG	Return Loss (dB)
SWR	Standing Wave Ratio (unitless)

Transmission Measurements Using Bandpass Mode

The bandpass mode can also transform transmission measurements to the time domain. For example, this mode can provide information about a surface acoustic wave (SAW) filter that is not apparent in the frequency domain. Figure 6-63 illustrates a time domain bandpass measurement of a 321 MHz SAW filter.

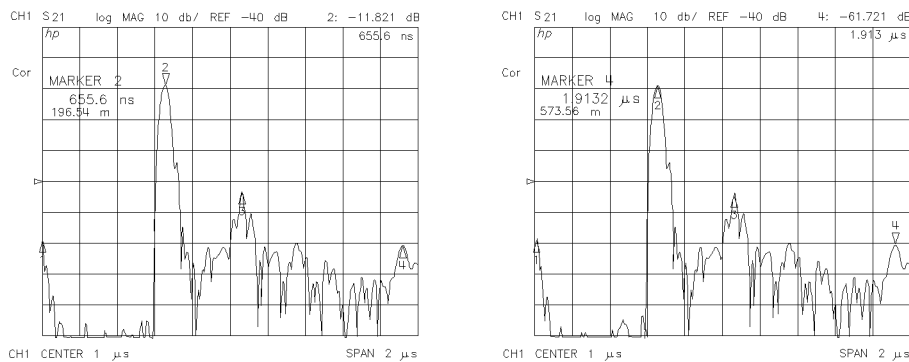

pg678d

Figure 6-63. Transmission Measurement in Time Domain Bandpass Mode

Interpreting the bandpass transmission response horizontal axis. In time domain transmission measurements, the horizontal axis is displayed in units of time. The time axis indicates the propagation delay through the device. Note that in time domain transmission measurements, the value displayed is the actual delay (not x2). The marker provides the propagation delay in both time and distance.

Marker 2 in Figure 6-63a indicates the main path response through the test device, which has a propagation delay of 655.6 ns, or about 196.5 meters in electrical length. Marker 4 in Figure 6-63b indicates the triple-travel path response at 1.91 μs, or about 573.5 meters. The response at marker 1 (at 0 seconds) is an RF feedthru leakage path. In addition to the triple travel path response, there are several other multi-path responses through the test device, which are inherent in the design of a SAW filter.

Interpreting the bandpass transmission response vertical axis. In the log magnitude format, the vertical axis displays the transmission loss or gain in dB; in the linear magnitude format it displays the transmission coefficient (τ). Think of this as an average of the transmission response over the measurement frequency range.

Time domain low pass

This mode is used to simulate a traditional time domain reflectometry (TDR) measurement. It provides information to determine the type of discontinuity (resistive, capacitive, or inductive) that is present. Low pass provides the best resolution for a given bandwidth in the frequency domain. It may be used to give either the step or impulse response of the test device.

The low pass mode is less general-purpose than the bandpass mode because it places strict limitations on the measurement frequency range. The low pass mode requires that the frequency domain data points are harmonically related from dc to the stop frequency. That is, $\text{stop} = n \times \text{start}$, where $n = \text{number of points}$. For example, with a start frequency of 30 kHz and 101 points, the stop frequency would be 3.03 MHz. Since the analyzer frequency range starts at 30 kHz, the dc frequency response is extrapolated from the lower frequency data. The requirement to pass dc is the same limitation that exists for traditional TDR.

Setting frequency range for time domain low pass

Before a low pass measurement is made, the measurement frequency range must meet the ($\text{stop} = n \times \text{start}$) requirement described above. The **SET FREQ LOW PASS** softkey performs this function automatically: the stop frequency is set close to the entered stop frequency, and the start frequency is set equal to stop/n .

If the low end of the measurement frequency range is critical, it is best to calculate approximate values for the start and stop frequencies before pressing **SET FREQ LOW PASS** and calibrating. This avoids distortion of the measurement results. To see an example, select the preset values of 201 points and a 300 kHz to 3 GHz frequency range. Now press **SET FREQ LOW PASS** and observe the change in frequency values. The stop frequency changes to 2.999 GHz, and the start frequency changes to 14.925 MHz. This would cause a distortion of measurement results for frequencies from 300 kHz to 14.925 MHz.

Note If the start and stop frequencies do not conform to the low pass requirement before a low pass mode (step or impulse) is selected and transform is turned on, the analyzer resets the start and stop frequencies. If error correction is on when the frequency range is changed, this turns it off.

Table 6-10. Minimum Frequency Ranges for Time Domain Low Pass

Number of Points	Minimum Frequency Range
3	30 kHz to 0.09 MHz
11	30 kHz to 0.33 MHz
26	30 kHz to 0.78 MHz
51	30 kHz to 1.53 MHz
101	30 kHz to 3.03 MHz
201	30 kHz to 6.03 MHz
401	30 kHz to 12.03 MHz
801	30 kHz to 24.03 MHz
1601	30 kHz to 48.03 MHz

Minimum allowable stop frequencies. The lowest analyzer measurement frequency is 30 kHz, therefore for each value of n there is a minimum allowable stop frequency that can be used. That is, the minimum stop frequency = $n \times 30$ kHz. Table 6-10 lists the minimum frequency range that can be used for each value of n for low pass time domain measurements.

Reflection Measurements In Time Domain Low Pass

Figure 6-64 shows the time domain response of an unterminated cable in both the low-pass step and low-pass impulse modes.

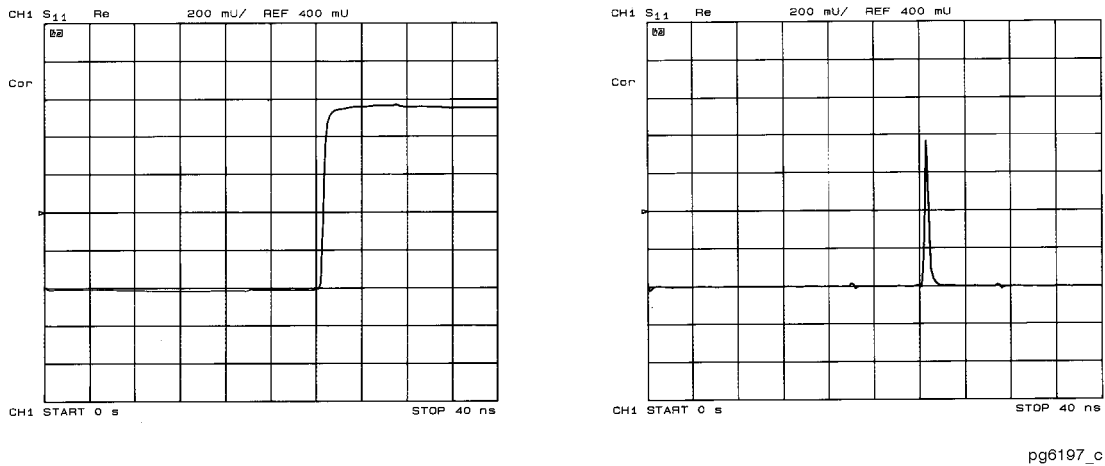

pg6197_c

Figure 6-64.
Time Domain Low Pass Measurements of an Unterminated Cable

Interpreting the low pass response horizontal axis. The low pass measurement horizontal axis is the two-way travel time to the discontinuity (as in the bandpass mode). The marker displays both the two-way time and the electrical length along the trace. To determine the actual physical length, enter the appropriate velocity factor as described earlier in this section under “Time domain bandpass.”

Interpreting the low pass response vertical axis. The vertical axis depends on the chosen format. In the low pass mode, the frequency domain data is taken at harmonically related frequencies and extrapolated to dc. Because this results in the inverse Fourier transform having only a real part (the imaginary part is zero), the most useful low pass step mode format in this application is the real format. It displays the response in reflection coefficient units. This mode is similar to the traditional TDR response, which displays the reflected signal in a real format (volts) versus time (or distance) on the horizontal axis.

The real format can also be used in the low pass impulse mode, but for the best dynamic range for simultaneously viewing large and small discontinuities, use the log magnitude format.

Fault Location Measurements Using Low Pass

As described, the low pass mode can simulate the TDR response of the test device. This response contains information useful in determining the type of discontinuity present.

Figure 6-65 illustrates the low pass responses of known discontinuities. Each circuit element was simulated to show the corresponding low pass time domain S₁₁ response waveform. The low pass mode gives the test device response either to a step or to an impulse stimulus. Mathematically, the low pass impulse stimulus is the derivative of the step stimulus.

ELEMENT	STEP RESPONSE	IMPULSE RESPONSE
OPEN	 UNITY REFLECTION	 UNITY REFLECTION
SHORT	 UNITY REFLECTION, -180°	 UNITY REFLECTION, -180°
RESISTOR $R > Z_0$	 POSITIVE LEVEL SHIFT	 POSITIVE PEAK
RESISTOR $R < Z_0$	 NEGATIVE LEVEL SHIFT	 NEGATIVE PEAK
INDUCTOR	 POSITIVE PEAK	 POSITIVE THEN NEGATIVE PEAKS
CAPACITOR	 NEGATIVE PEAK	 NEGATIVE THEN POSITIVE PEAKS

pg6127d

Figure 6-65. Simulated Low Pass Step and Impulse Response Waveforms (Real Format)

Figure 6-66 shows example cables with discontinuities (faults) using the low pass step mode with the real format.

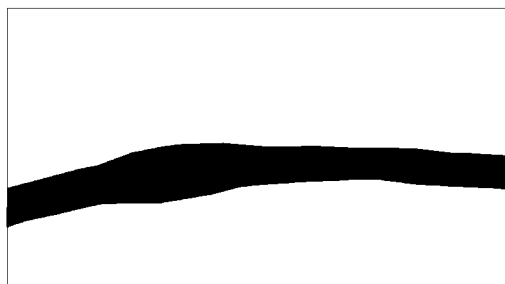
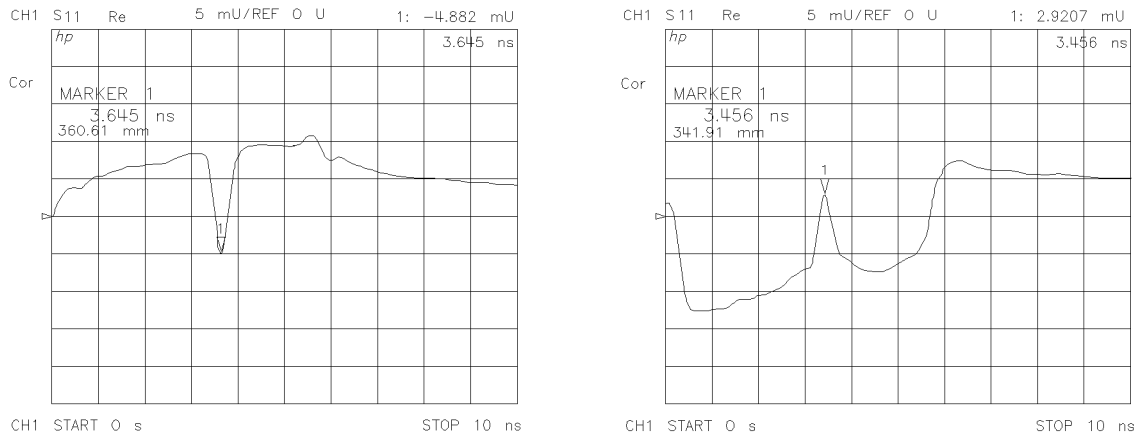

(a) Crimped Cable (Capacitive)

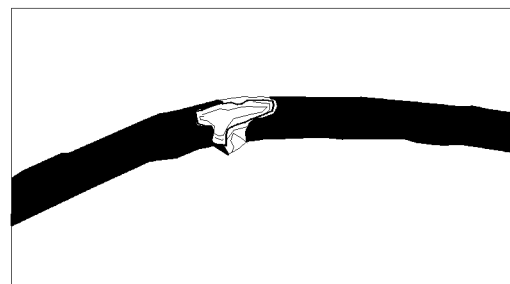

(b) Frayed Cable (Inductive)

pg6123d

Figure 6-66. Low Pass Step Measurements of Common Cable Faults (Real Format)

Transmission Measurements In Time Domain Low Pass

Measuring small signal transient response using low pass step. Use the low pass mode to analyze the test device's small signal transient response. The transmission response of a device to a step input is often measured at lower frequencies, using a function generator (to provide the step to the test device) and a sampling oscilloscope (to analyze the test device output response). The low pass step mode extends the frequency range of this type of measurement to 3 GHz (6 GHz with an analyzer Option 006).

The step input shown in Figure 6-67 is the inverse Fourier transform of the frequency domain response of a thru measured at calibration. The step rise time is proportional to the highest frequency in the frequency domain sweep; the higher the frequency, the faster the rise time. The frequency sweep in Figure 6-67 is from 10 MHz to 1 GHz.

Figure 6-67 also illustrates the time domain low pass response of an amplifier under test. The average group delay over the measurement frequency range is the difference in time between the step and the amplifier response. This time domain response simulates an oscilloscope measurement of the amplifier's small signal transient response. Note the ringing in the amplifier response that indicates an under-damped design.

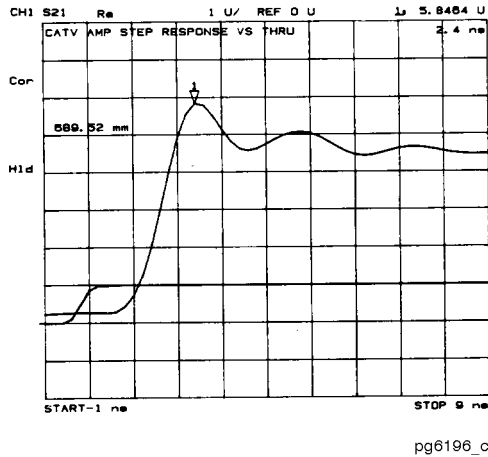

Figure 6-67.
Time Domain Low Pass Measurement of an Amplifier Small Signal Transient Response

Interpreting the low pass step transmission response horizontal axis. The low pass transmission measurement horizontal axis displays the average transit time through the test device over the frequency range used in the measurement. The response of the thru connection used in the calibration is a step that reaches 50% unit height at approximately time = 0. The rise time is determined by the highest frequency used in the frequency domain measurement. The step is a unit high step, which indicates no loss for the thru calibration. When a device is inserted, the time axis indicates the propagation delay or electrical length of the device. The markers read the electrical delay in both time and distance. The distance can be scaled by an appropriate velocity factor as described earlier in this section under “Time domain bandpass.”

Interpreting the low pass step transmission response vertical axis. In the real format, the vertical axis displays the transmission response in real units (for example, volts). For the amplifier example in Figure 6-67, if the amplifier input is a step of 1 volt, the output, 2.4 nanoseconds after the step (indicated by marker 1), is 5.84 volts.

In the log magnitude format, the amplifier gain is the steady state value displayed after the initial transients die out.

Measuring separate transmission paths through the test device using low pass impulse mode. The low pass impulse mode can be used to identify different transmission paths through a test device that has a response at frequencies down to dc (or at least has a predictable response, above the noise floor, below 30 kHz). For example, use the low pass impulse mode to measure the relative transmission times through a multi-path device such as a power divider. Another example is to measure the pulse dispersion through a broadband transmission line, such as a fiber optic cable. Both examples are illustrated in Figure 6-68. The horizontal and vertical axes can be interpreted as already described in this section under “Time Domain Bandpass”.

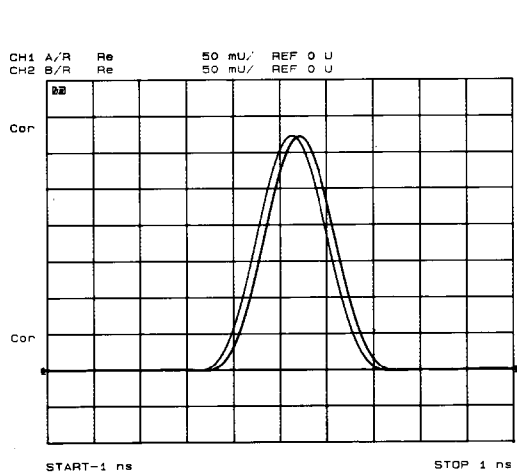

(a) Comparing Transmission Paths through a Power Divider

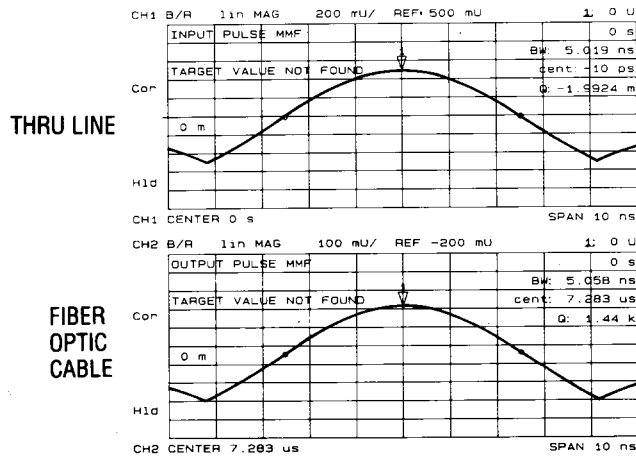

(b) Measuring Pulse Dispersion on a 1.5 km Fiber Optic Cable

pg6195_c

Figure 6-68. Transmission Measurements Using Low Pass Impulse Mode

Time Domain Concepts

Masking

Masking occurs when a discontinuity (fault) closest to the reference plane affects the response of each subsequent discontinuity. This happens because the energy reflected from the first discontinuity never reaches subsequent discontinuities. For example, if a transmission line has two discontinuities that each reflect 50% of the incident voltage, the time domain response (real format) shows the correct reflection coefficient for the first discontinuity ($\rho=0.50$). However, the second discontinuity appears as a 25% reflection ($\rho=0.25$) because only half the incident voltage reached the second discontinuity.

Note This example assumes a loss-less transmission line. Real transmission lines, with non-zero loss, attenuate signals as a function of the distance from the reference plane.

As an example of masking due to line loss, consider the time domain response of a 3 dB attenuator and a short circuit. The impulse response (log magnitude format) of the short circuit alone is a return loss of 0 dB, as shown in Figure 6-69a. When the short circuit is placed at the end of the 3 dB attenuator, the return loss is -6 dB, as shown in Figure 6-69b. This value actually represents the forward and return path loss through the attenuator, and illustrates how a lossy network can affect the responses that follow it.

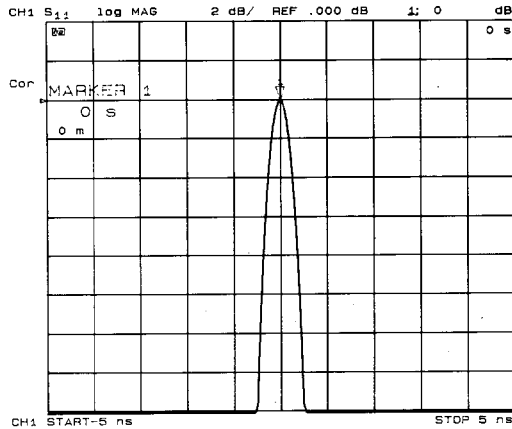

(a) Short Circuit

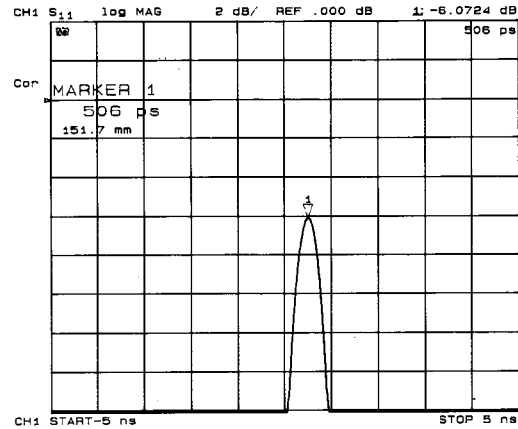

(b) Short Circuit at the End of a 3 dB Pad

pg6194_c

Figure 6-69. Masking Example

Windowing

The analyzer provides a windowing feature that makes time domain measurements more useful for isolating and identifying individual responses. Windowing is needed because of the abrupt transitions in a frequency domain measurement at the start and stop frequencies. The band limiting of a frequency domain response causes overshoot and ringing in the time domain response, and causes a non-windowed impulse stimulus to have a $\text{sin}(kt)/kt$ shape, where $k = \pi/\text{frequency span}$ and $t = \text{time}$ (see Figure 6-70). This has two effects that limit the usefulness of the time domain measurement:

- **Finite impulse width (or rise time).** Finite impulse width limits the ability to resolve between two closely spaced responses. The effects of the finite impulse width cannot be improved without increasing the frequency span of the measurement (see Table 6-11).

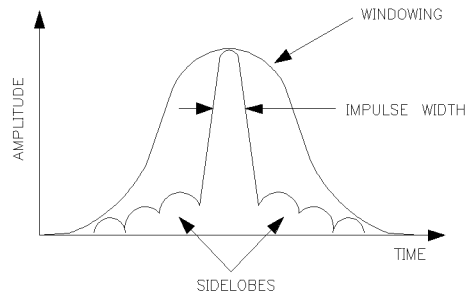

pg665d

Figure 6-70. Impulse Width, Sidelobes, and Windowing

- **Sidelobes.** The impulse sidelobes limit the dynamic range of the time domain measurement by hiding low-level responses within the sidelobes of higher level responses. The effects of sidelobes can be improved by windowing (see Table 6-11).

Windowing improves the dynamic range of a time domain measurement by filtering the frequency domain data prior to converting it to the time domain, producing an impulse stimulus that has lower sidelobes. This makes it much easier to see time domain responses that are very different in magnitude. The sidelobe reduction is achieved, however, at the expense of

increased impulse width. The effect of windowing on the step stimulus (low pass mode only) is a reduction of overshoot and ringing at the expense of increased rise time.

To select a window, press **SYSTEM** **TRANSFORM MENU** **WINDOW**. A menu is presented that allows the selection of three window types (see Table 6-11).

Table 6-11. Impulse Width, Sidelobe Level, and Windowing Values

Window Type	Impulse Sidelobe Level	Low Pass Impulse Width (50%)	Step Sidelobe Level	Step Rise Time (10 - 90%)
Minimum	-13 dB	0.60/Freq Span	-21 dB	0.45/Freq Span
Normal	-44 dB	0.98/Freq Span	-60 dB	0.99/Freq Span
Maximum	-75 dB	1.39/Freq Span	-70 dB	1.48/Freq Span

NOTE: The bandpass mode simulates an impulse stimulus. Bandpass impulse width is twice that of low pass impulse width. The bandpass impulse sidelobe levels are the same as low pass impulse sidelobe levels.

Choose one of the three window shapes listed in Table 6-11. Or you can use the knob to select any windowing pulse width (or rise time for a step stimulus) between the softkey values. The time domain stimulus sidelobe levels depend only on the window selected.

- MINIMUM** is essentially no window. Consequently, it gives the highest sidelobes.
- NORMAL** (the preset mode) gives reduced sidelobes and is the mode most often used.
- MAXIMUM** window gives the minimum sidelobes, providing the greatest dynamic range.
- USE MEMORY on OFF** remembers a user-specified window pulse width (or step rise time) different from the standard window values.

A window is activated only for viewing a time domain response, and does not affect a displayed frequency domain response. Figure 6-71 shows the typical effects of windowing on the time domain response of a short circuit reflection measurement.

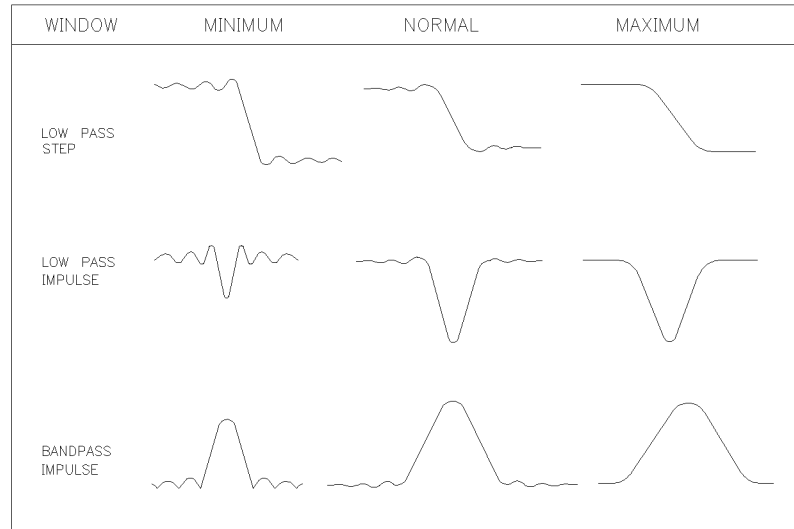

pb664d

Figure 6-71. The Effects of Windowing on the Time Domain Responses of a Short Circuit Range

In the time domain, range is defined as the length in time that a measurement can be made without encountering a repetition of the response, called aliasing. A time domain response repeats at regular intervals because the frequency domain data is taken at discrete frequency points, rather than continuously over the frequency band.

$$\text{Measurement range} = \frac{1}{\Delta F}$$

where ΔF is the spacing between frequency data points

$$\text{Measurement range} = \frac{(\text{number of points} - 1)}{\text{frequency span(Hz)}}$$

example:

$$\text{Measurement} = 201 \text{ points}$$

$$1 \text{ MHz to } 2.001 \text{ GHz}$$

$$\text{Range} = \frac{1}{\Delta F} \text{ or } \frac{(\text{number of points} - 1)}{\text{frequency span}}$$

$$= \frac{1}{(10 \times 10^6)} \text{ or } \frac{(201 - 1)}{(2 \times 10^9)}$$

$$= 100 \times 10^{-9} \text{ seconds}$$

$$\text{Electrical length} = \text{range} \times \text{the speed of light } (3 \times 10^8 \text{ m/s})$$

$$= (100 \times 10^{-9} \text{ s}) \times (3 \times 10^8 \text{ m/s})$$

$$= 30 \text{ meters}$$

In this example, the range is 100 ns, or 30 meters electrical length. To prevent the time domain responses from overlapping, the test device must be 30 meters or less in electrical length for a transmission measurement (15 meters for a reflection measurement). The analyzer limits the stop time to prevent the display of aliased responses.

To increase the time domain measurement range, first increase the number of points, but remember that as the number of points increases, the sweep speed decreases. Decreasing the frequency span also increases range, but reduces resolution.

Resolution

Two different resolution terms are used in the time domain:

- response resolution
- range resolution

Response resolution. Time domain response resolution is defined as the ability to resolve two closely-spaced responses, or a measure of how close two responses can be to each other and still be distinguished from each other. For responses of equal amplitude, the response resolution is equal to the 50% (–6 dB) impulse width. It is inversely proportional to the measurement frequency span, and is also a function of the window used in the transform. The approximate formulas for calculating the 50% impulse width are given in Table 6-11. For example, using the formula for the bandpass mode with a normal windowing function for a 50 MHz to 13.05 GHz measurement (13.0 GHz span):

$$\begin{aligned} 50\% \text{ calculated impulse width} &= \frac{0.98}{13.0 \text{ (GHz)}} \times 2 \\ &= 0.151 \text{ nanoseconds} \\ \text{Electrical length (in air)} &= (0.151 \times 10^{-9} \text{ s}) \times (30 \times 10^9 \text{ cm/s}) \\ &= 4.53 \text{ centimeters} \end{aligned}$$

With this measurement, two equal responses can be distinguished when they are separated by at least 4.53 centimeters. In a measurement with a 20 GHz span, two equal responses can be distinguished when they are separated by at least 2.94 cm. Using the low pass mode (the low pass frequencies are slightly different) with a minimum windowing function, you can distinguish two equal responses that are about 1.38 centimeters or more apart.

For reflection measurements, which measure the two-way time to the response, divide the response resolution by 2. Using the example above, you can distinguish two faults of equal magnitude provided they are 0.69 centimeters (electrical length) or more apart.

Note Remember, to determine the physical length, the relative velocity factor of the transmission medium under test must be entered into the electrical length equation.

For example, a cable with a teflon dielectric (0.7 relative velocity factor), measured under the conditions stated above, has a fault location measurement response resolution of 0.45 centimeters. This is the maximum fault location response resolution. Factors such as reduced frequency span, greater frequency domain data windowing, and a large discontinuity shadowing the response of a smaller discontinuity, all act to degrade the effective response resolution.

Figure 6-72 illustrates the effects of response resolution. The solid line shows the actual reflection measurement of two approximately equal discontinuities (the input and output of an SMA barrel). The dashed line shows the approximate effect of each discontinuity, if they could be measured separately.

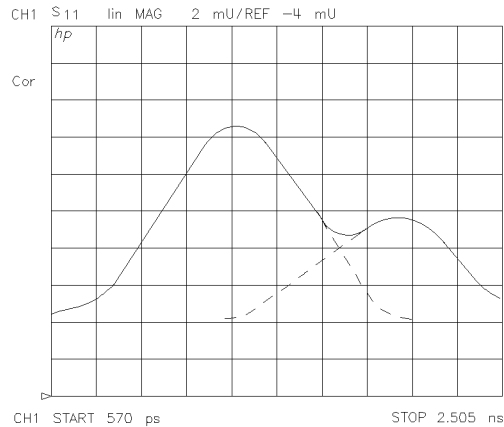

pg682d

Figure 6-72. Response Resolution

While increasing the frequency span increases the response resolution, keep the following points in mind:

- The time domain response noise floor is directly related to the frequency domain data noise floor. Because of this, if the frequency domain data points are taken at or below the measurement noise floor, the time domain measurement noise floor is degraded.
- The time domain measurement is an average of the response over the frequency range of the measurement. If the frequency domain data is measured out-of-band, the time domain measurement is also the out-of-band response.

You may (with these limitations in mind) choose to use a frequency span that is wider than the test device bandwidth to achieve better resolution.

Range resolution. Time domain range resolution is defined as the ability to locate a single response in time. If only one response is present, range resolution is a measure of how closely you can pinpoint the peak of that response. The range resolution is equal to the digital resolution of the display, which is the time domain span divided by the number of points on the display. To get the maximum range resolution, center the response on the display and reduce the time domain span. The range resolution is always much finer than the response resolution (see Figure 6-73).

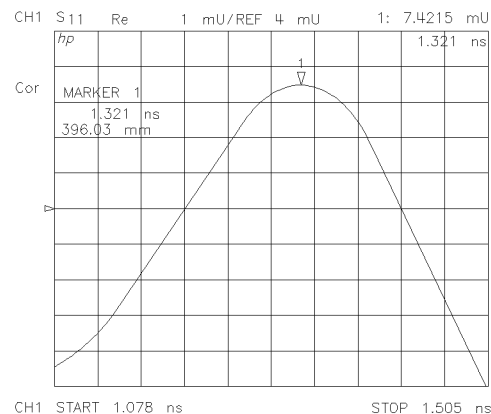

pg683d

Figure 6-73. Range Resolution of a Single Discontinuity

Gating

Gating provides the flexibility of selectively removing time domain responses. The remaining time domain responses can then be transformed back to the frequency domain. For reflection (or fault location) measurements, use this feature to remove the effects of unwanted discontinuities in the time domain. You can then view the frequency response of the remaining discontinuities. In a transmission measurement, you can remove the effects of multiple transmission paths.

Figure 6-74a shows the frequency response of an electrical airline and termination. Figure 6-74b shows the response in the time domain. The discontinuity on the left is due to the input connector. The discontinuity on the right is due to the termination. We want to remove the effect of the connector so that we can see the frequency response of just the airline and termination. Figure 6-74c shows the gate applied to the connector discontinuity. Figure 6-74d shows the frequency response of the airline and termination, with the connector “gated out.”

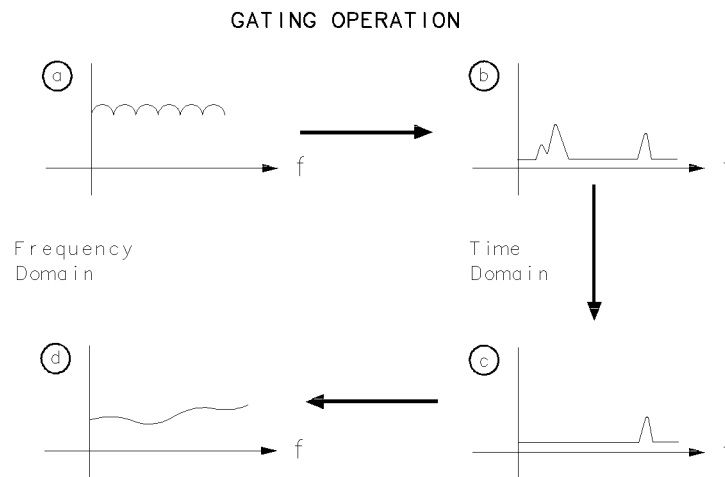

pb666d

Figure 6-74. Sequence of Steps in Gating Operation

Setting the gate. Think of a gate as a bandpass filter in the time domain (see Figure 6-75). When the gate is on, responses outside the gate are mathematically removed from the time domain trace. Enter the gate position as a start and stop time (not frequency) or as a center and span time. The start and stop times are the bandpass filter -6 dB cutoff times. Gates can have a negative span, in which case the responses inside the gate are mathematically removed. The gate's start and stop flags define the region where gating is *on*.

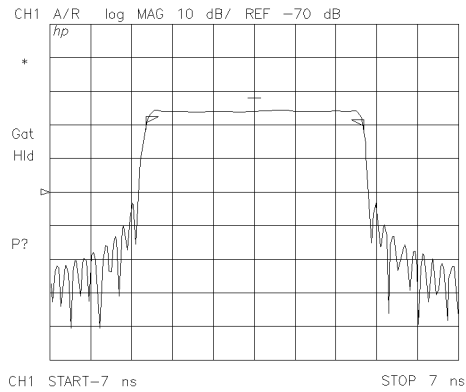

pg6121d

Figure 6-75. Gate Shape

Selecting gate shape. The four gate shapes available are listed in Table 6-12. Each gate has a different passband flatness, cutoff rate, and sidelobe levels.

Table 6-12. Gate Characteristics

Gate Shape	Passband Ripple	Sidelobe Levels	Cutoff Time	Minimum Gate Span
Gate Span Minimum	± 0.10 dB	-48 dB	1.4/Freq Span	2.8/Freq Span
Normal	± 0.01 dB	-68 dB	2.8/Freq Span	5.6/Freq Span
Wide	± 0.01 dB	-57 dB	4.4/Freq Span	8.8/Freq Span
Maximum	± 0.01 dB	-70 dB	12.7/Freq Span	25.4/Freq Span

The passband ripple and sidelobe levels are descriptive of the gate shape. The cutoff time is the time between the stop time (-6 dB on the filter skirt) and the peak of the first sidelobe, and is equal on the left and right side skirts of the filter. Because the minimum gate span has no passband, it is just twice the cutoff time. Always choose a gate span wider than the minimum. For most applications, do not be concerned about the minimum gate span, simply use the knob to position the gate markers around the desired portion of the time domain trace.

Transforming CW Time Measurements Into the Frequency Domain

The analyzer can display the amplitude and phase of CW signals versus time. For example, use this mode for measurements such as amplifier gain as a function of warm-up time (i.e. drift). The analyzer can display the measured parameter (e.g. amplifier gain) for periods of up to 24 hours and then output the data to a digital plotter for hardcopy results.

These “strip chart” plots are actually measurements as a function of time (time is the independent variable), and the horizontal display axis is scaled in time units. Transforms of these measurements result in frequency domain data. Such transforms are called forward transforms because the transform from time to frequency is a forward Fourier transform, and can be used to measure the spectral content of a CW signal. For example, when transformed into the frequency domain, a pure CW signal measured over time appears as a single frequency spike. The transform into the frequency domain yields a display that looks similar to a spectrum analyzer display of signal amplitude versus frequency.

Forward Transform Measurements

This is an example of a measurement using the Fourier transform in the forward direction, from the time domain to the frequency domain (see Figure 6-76):

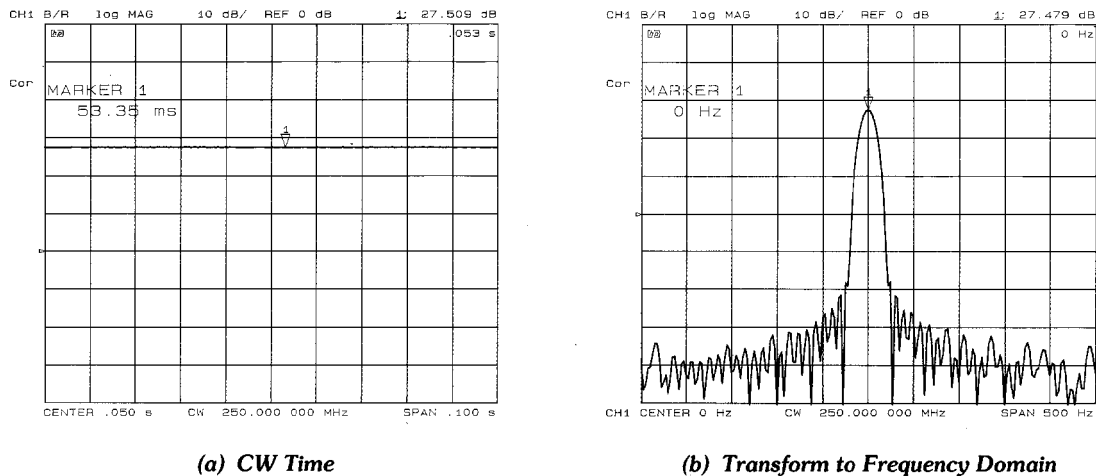

pg6189_c

Figure 6-76. Amplifier Gain Measurement

Interpreting the forward transform vertical axis. With the log magnitude format selected, the vertical axis displays dB. This format simulates a spectrum analyzer display of power versus frequency.

Interpreting the forward transform horizontal axis. In a frequency domain transform of a CW time measurement, the horizontal axis is measured in units of frequency. The center frequency is the offset of the CW frequency. For example, with a center frequency of 0 Hz, the CW frequency (250 MHz in the example) is in the center of the display. If the center frequency entered is a positive value, the CW frequency shifts to the right half of the display; a negative value shifts it to the left half of the display. The span value entered with the transform on is the total frequency span shown on the display. (Alternatively, the frequency display values can be entered as start and stop.)

Demodulating the results of the forward transform. The forward transform can separate the effects of the CW frequency modulation amplitude and phase components. For example, if a test device modulates the transmission response (S_{21}) with a 500 Hz AM signal, you can see the effects of that modulation as shown in Figure 6-77. To simulate this effect, apply a 500 Hz sine wave to the analyzer rear panel EXT AM input.

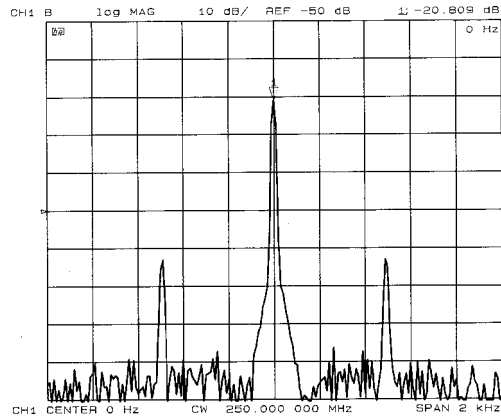

pg6187_c

Figure 6-77. Combined Effects of Amplitude and Phase Modulation

Using the demodulation capabilities of the analyzer, it is possible to view the amplitude or the phase component of the modulation separately. The window menu includes the following softkeys to control the demodulation feature:

- DEMOD: OFF** is the normal preset state, in which both the amplitude and phase components of any test device modulation appear on the display.
- AMPLITUDE** displays only the amplitude modulation, as illustrated in Figure 6-78a.
- PHASE** displays only the phase modulation, as shown in Figure 6-78b.

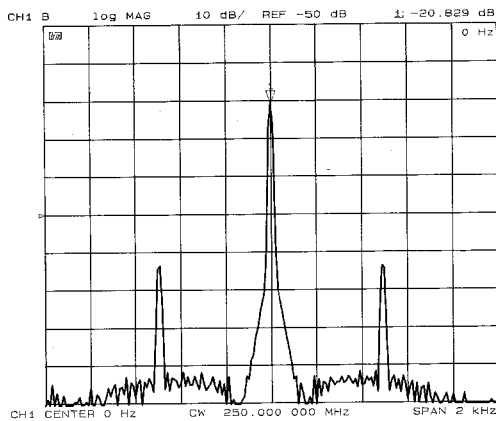

(a) Amplitude Modulation Component

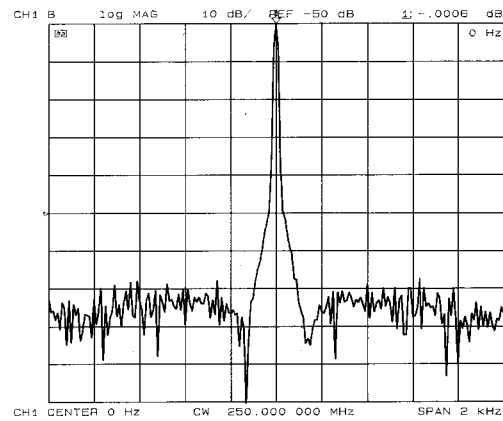

(b) Phase Modulation Component

pg6188_c

Figure 6-78. Separating the Amplitude and Phase Components of Test-Device-Induced Modulation

Forward transform range. In the forward transform (from CW time to the frequency domain), range is defined as the frequency span that can be displayed before aliasing occurs, and is similar to range as defined for time domain measurements. In the range formula, substitute time span for frequency span.

Example:

$$\begin{aligned}
 \text{Range} &= \frac{\text{Number of points} - 1}{\text{time span}} \\
 &= \frac{201 - 1}{200 \times 10^{-3}} \\
 &= 1000 \text{ Hertz}
 \end{aligned}$$

For the example given above, a 201 point CW time measurement made over a 200 ms time span, choose a span of 1 kHz or less on either side of the center frequency (see Figure 6-79). That is, choose a total span of 2 kHz or less.

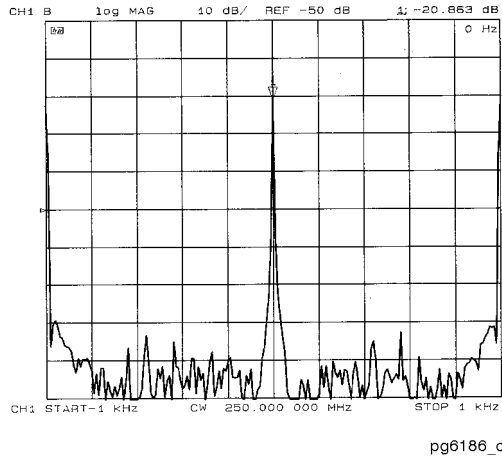

Figure 6-79. Range of a Forward Transform Measurement

To increase the frequency domain measurement range, increase the span. The maximum range is inversely proportional to the sweep time, therefore it may be necessary to increase the number of points or decrease the sweep time. Because increasing the number of points increases the auto sweep time, the maximum range is 2 kHz on either side of the selected CW time measurement center frequency (4 kHz total span). To display a total frequency span of 4 kHz, enter the span as 4000 Hz.

Test Sequencing

Test sequencing is an analyzer function that allows you to automate repetitive tasks. You can create a sequence as you are making a measurement. Then when you want to make that same measurement again, you can recall the sequence and the analyzer will repeat the previous keystrokes.

The following is a list of some of the key test sequencing features available on the HP 8753D network analyzer:





- Limited decision-making functions increase the versatility of the test sequences you create by allowing you to jump from one sequence to another.
- A `GOSUB SEQUENCE` function that allows you to call other sequences as sub-routines.
- You can create, title, save, and execute up to six sequences.
- You can save your sequences to a disk using the internal disk drive.
- You can use the parallel port as a general purpose input/output (GPIO) bus to read five TTL input bits in a decision making function, and send eight TTL output bits to control a peripheral.

Note	Product note 8753-3 “RF Component Measurements – Applications of the Test Sequence Function” provides practical applications examples for test sequencing. This note was written for the HP 8753B but also applies to the HP 8753D.
-------------	---

In-Depth Sequencing Information

Features That Operate Differently When Executed In a Sequence

The analyzer does not allow you to use the following keys in a sequence:

-   keys
-  key
-  key

Commands That Sequencing Completes Before the Next Sequence Command Begins

The analyzer completes all operations related to the following commands before continuing with another sequence command:

- single sweep
- number of groups
- auto scale
- marker search
- marker function
- data → memory
- recall or save (internal or external)
- copy list values and operating parameters
- CHAN1, CHAN2, Wait 0*

*Wait 0 is the special sequencing function `WAIT x` with a zero entered for the delay value.

Commands That Require a Clean Sweep

Many front panel commands disrupt the sweep in progress. For example, changing the channel or measurement type. When the analyzer does execute a disruptive command in a sequence, some instrument functions are inhibited until a complete sweep is taken. This applies to the following functions:

- autoscale
- data → memory

Forward Stepping In Edit Mode

In the sequence modify mode, you can step through the selected sequence list, where the analyzer executes each step.

Titles

A title may contain non-printable or special ASCII characters if you download it from an external controller. A non-printable character is represented on the display as π .

Sequence Size

A sequence may contain up to 2 kbytes of instructions. Typically, this is around 200 sequence command lines. To estimate a sequence's size (in kbytes), use the following guidelines.

Type of Command	Size in Bytes
Typical command	2
Title string character	1
Active entry command	1 per digit

Embedding the Value of the Loop Counter In a Title

You can append a sequentially increasing or decreasing numeric value to the title of stored data by placing a `(DISPLAY) MORE TITLE MORE LOOP COUNTER` command after the title string. (You must limit the title to three characters if you will use it as a disk file name. The three-character title and five-digit loop counter number reach the eight-character limit for disk file names.) This feature is useful in data logging applications.

Autostarting Sequences

You can define a sequence to run automatically when you apply power to the analyzer. To make an autostarting sequence, create a sequence in position six and title it "AUTO". To stop an autostarting sequence, press `(LOCAL)`. To stop an autostarting sequence from engaging at power on, you must clear it from memory or rename it.

The GPIO Mode

The instrument's parallel port can be used in two different modes. By pressing `(LOCAL)` and then toggling the `PARALLEL []` softkey, you can select either the `[COPY]` mode or the `[GPIO]` mode.

The GPIO mode switches the parallel port into a "general purpose input/output" port.

In this mode, the port can be connected to test fixtures, power supplies, and other peripheral equipment that the analyzer can interact with through test sequencing.

The Sequencing Menu

Pressing the **(SEQ)** key accesses the Sequencing menu. This menu leads to a series of menus that allow you to create and control sequences.

Gosub Sequence Command

The **GOSUB SEQUENCE** softkey, located in the Sequencing menu, activates a feature that allows the sequence to branch off to another sequence, then return to the original sequence. For example, you could perform an amplifier measurement in the following manner:

1. Create sequence 1 for the specific purpose of performing the gain measurement and printing the results. This sequence will act as a sub-routine.
2. Create sequence 2 to set up a series of different input power levels for the amplifier gain measurements. In-between each power level setting, call sequence 1 as a sub-routine by pressing **GOSUB SEQUENCE SEQUENCE 1**. Now, sequence 2 will print the measurement results for each input power level applied to the amplifier.

TTL I/O Menu

This menu can be accessed by pressing **TTL I/O** in the Sequencing menu.

TTL Output for Controlling Peripherals

Eight TTL compatible output lines can be used for controlling equipment connected to the parallel port. By pressing **(SEQ) TTL I/O** you will access the softkeys (listed below) that control the individual output bits. Refer to Figure 6-80 for output bus pin locations.

PARALLEL OUT ALL lets you input a number (0 to 255) in base 10 and outputs it to the bus as binary.

SET BIT lets you set a single bit (0 - 7) to high on the output bus.

CLEAR BIT lets you set a single bit (0 - 7) to low on the output bus.

TTL Input Decision Making

Five TTL compatible input lines can be used for decision making in test sequencing. For example, if a test fixture is connected to the parallel port and has a micro switch that needs to be activated in order to proceed with a measurement, you can construct your test sequence so that it checks the TTL state of the input line corresponding to the switch. Depending on whether the line is high or low, you can jump to another sequence. To access these decision making functions, press **(SEQ) TTL I/O**. Refer to Figure 6-80 for input bus pin locations.

PARALL IN BIT NUMBER lets you select the single bit (0 - 4) that the sequence will be looking for.

PARALL IN IF BIT H lets you jump to another sequence if the single input bit you selected is in a high state.

PARALL IN IF BIT L lets you jump to another sequence if the single input bit you selected is in a low state.

Pin assignments:

- pin 1 is the data strobe
- pin 16 selects the printer

- pin 17 resets the printer
- pins 18-25 are ground

Electrical specifications for TTL high:

- volts(H) = 2.7 volts (V)
- current = 20 microamps (μA)

Electrical specifications for TTL low:

- volts(L) = 0.4 volts (V)
- current = 0.2 milliamps (mA)

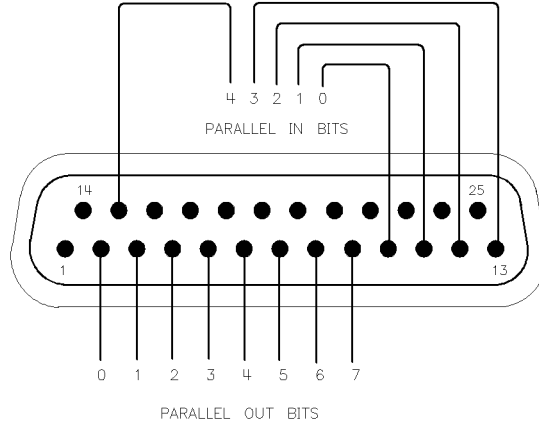

pg6129d

Figure 6-80. Parallel Port Input and Output Bus Pin Locations in GPIO Mode

TTL Out Menu

The `TTL OUT` softkey provides access to the TTL out menu. This menu allows you to choose between the following output parameters of the TTL output signal:

- `TTL OUT HIGH`
- `TTL OUT LOW`
- `END SWEEP HIGH PULSE`
- `END SWEEP LOW PULSE`

The TTL output signals are sent to the sequencing BNC rear panel output.

Sequencing Special Functions Menu

This menu is accessed by pressing the `SPECIAL FUNCTIONS` softkey in the Sequencing menu.

Sequence Decision Making Menu

This menu is accessed by pressing the `DECISION MAKING` softkey in the Sequencing Special Functions menu.

Decision making functions are explained in more detail below. These functions check a condition and jump to a specified sequence if the condition is true. The sequence called must be in memory. A sequence call is a one-way jump. A sequence can jump to itself, or to any of the other five sequences currently in memory. Use of these features is explained under the specific softkey descriptions.

Decision Making Functions

Decision making functions jump to a softkey location, not to a specific sequence title

Limit test, loop counter, and do sequence commands jump to any sequence residing in the specified sequence position (1 through 6). These commands do not jump to a specific sequence title. Whatever sequence is in the selected softkey position will run when these commands are executed.

Having a sequence jump to itself

A decision making command can jump to the sequence it is in. When this occurs, the sequence starts over and all commands in the sequence are repeated. This is used a great deal in conjunction with loop counter commands. See the loop counter description below.

TTL input decision making

TTL input from a peripheral connected to the parallel port (in the GPIO mode) can be used in a decision making function. Refer to “The GPIO Mode” earlier in this section.

Limit test decision making

A sequence can jump to another sequence or start over depending on the result of a limit test. When entered into a sequence, the `IF LIMIT TEST PASS` and `IF LIMIT TEST FAIL` commands require you to enter the destination sequence.

Loop counter decision making

The analyzer has a numeric register called a loop counter. The value of this register can be set by a sequence, and it can be incremented or decremented each time a sequence repeats itself. The decision making commands `IF LOOP COUNTER = 0` and `IF LOOP COUNTER <> 0` jump to another sequence if the stated condition is true. When entered into the sequence, these commands require you to enter the destination sequence. Either command can jump to another sequence, or restart the current sequence.

As explained earlier in “Embedding the Value of The Loop Counter in The Title,” the loop counter value can be appended to a title. This allows customized titles for data printouts or for data files saved to disk.

Naming Files Generated by a Sequence

The analyzer can automatically increment the name of a file that is generated by a sequence using a loop structure.

To access the sequence filename menu, press:

`SAVE/RECALL`

`FILE UTILITIES`

`SEQUENCE FILENAMING`

This menu presents two choices:

- `FILE NAME FILEO` supplies a name for the saved state and or data file. This also brings up the Title File Menu.
- `PLOT NAME PLOTFILE` supplies a name for the plot file generated by a plot-to-disk command. This also brings up the Title File Menu.

The above keys show the current filename in the 2nd line of the softkey.

When titling a file for use in a loop function, you are restricted to only 2 characters in the filename due to the 6 character length of the loop counter keyword “[LOOP].” When the file is actually written, the [LOOP] keyword is expanded to only 5 ASCII characters (digits), resulting in a 7 character filename.

After entering the 2 character filename, press:

`LOOP COUNTER DONE`

HP-GL Considerations

Entering HP-GL Commands

The analyzer allows you to use HP-GL (Hewlett-Packard Graphics Language) to customize messages or illustrations on the display of the analyzer. To use HP-GL, the instrument must be in system controller mode.

HP-GL commands should be entered into a title string using the `DISPLAY MORE TITLE` and character selection menu.

The `TITLE TO PERIPHERAL` sequencing command (in the Sequencing Special Functions menu) sends the HP-GL command string to the analyzer's HP-GL address. The address of the analyzer's HP-GL graphics interface is always offset from the instrument's HP-IB address by 1:

- If the current instrument address is an even number:
HP-GL address = instrument address + 1.
- If the current instrument address is an odd number:
HP-GL address = instrument address - 1.

Special Commands

Two HP-GL commands require special consideration when used in local operation or in sequencing. These are explained below:

Plot absolute (HP-GL command: PA)

The syntax for this command is `PAX,y` where `x` and `y` are screen location coordinates separated by a comma.

Label (HP-GL command: LB)

The syntax for this command is `LB[text][etx]`. The label command will print ASCII characters until the `etx` command is seen. The `etx` is the ASCII value 3 (not the ASCII character 3).

The analyzer title function does not have the ASCII value 3, so the instrument allows the LB command to be terminated with the `END OF LABEL` command (accessed by pressing `DISPLAY` `MORE TITLE MORE END OF LABEL`).

Entering Sequences Using HP-IB

You can create a sequence in a computer controller using HP-IB codes and enter it into the analyzer over HP-IB. This method replaces the keystrokes with HP-IB commands. The following is a procedure for entering a sequence over HP-IB:

1. Send the HP-IB command `NEWSEQx` where `x` is a number from 1 to 6.
2. Send the HP-IB commands for the measurement.
3. Terminate with the HP-IB command `DONM` (done modify).

Reading Sequences Using HP-IB

An external controller can read the commands in any sequence (in HP-IB command format). Send the following command to the analyzer:

`OUTPSEQx` where `x` is a number from 1 to 6.

Allocate an adequate amount of string variable space in the external controller and execute an `ENTER` statement.

Amplifier Testing

Amplifier parameters

The HP 8753D allows you to measure the transmission and reflection characteristics of many amplifiers and active devices. You can measure scalar parameters such as gain, gain flatness, gain drift, gain compression, reverse isolation, return loss (SWR), and gain drift versus time. Additionally, you can measure vector parameters such as deviation from linear phase, group delay, complex impedance and AM-to-PM conversion.

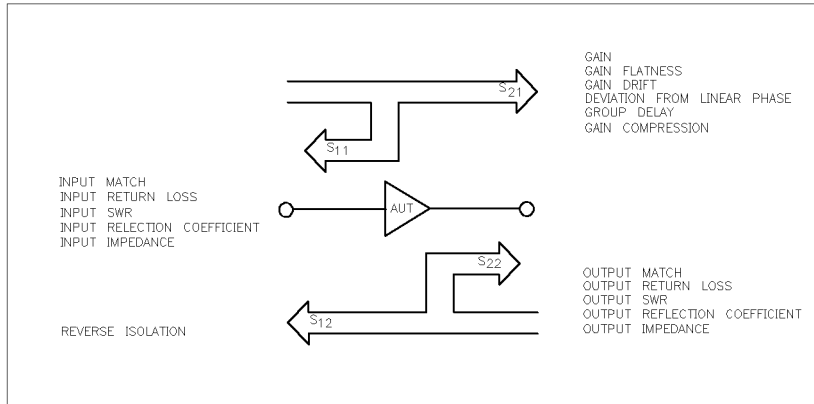

pg6137d

Figure 6-81. Amplifier Parameters

The analyzer allows you to make a swept-frequency measurement of an amplifier's second or third harmonic as shown in Figure 6-82.

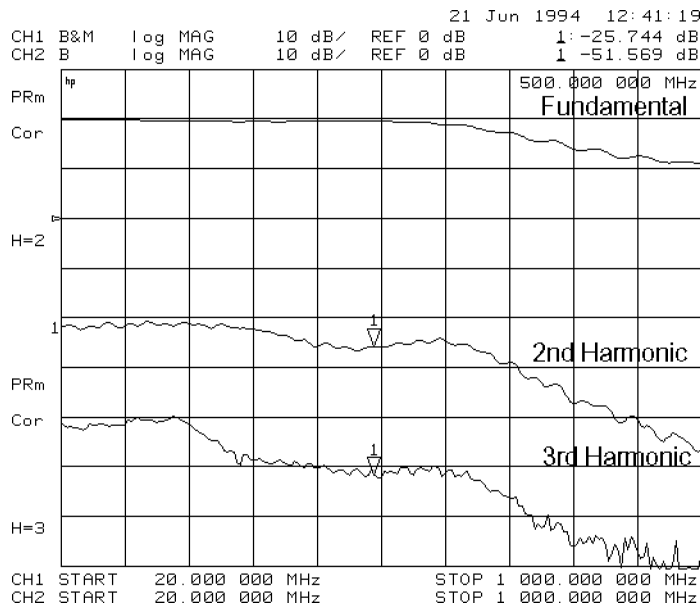

pg6239

Figure 6-82. Swept Frequency Amplifier Measurement of Absolute Fundamental, 2nd and 3rd Harmonic Output Levels

The second/third harmonic response can be displayed directly in dBc, or dB below the fundamental or carrier (see Figure 6-83). The ability to display harmonic level versus frequency or RF power allows “real-time” tuning of harmonic distortion. Further, this swept harmonic measurement, as well as all of the traditional linear amplifier measurements can be made without reconnecting the test device to a different test configuration.

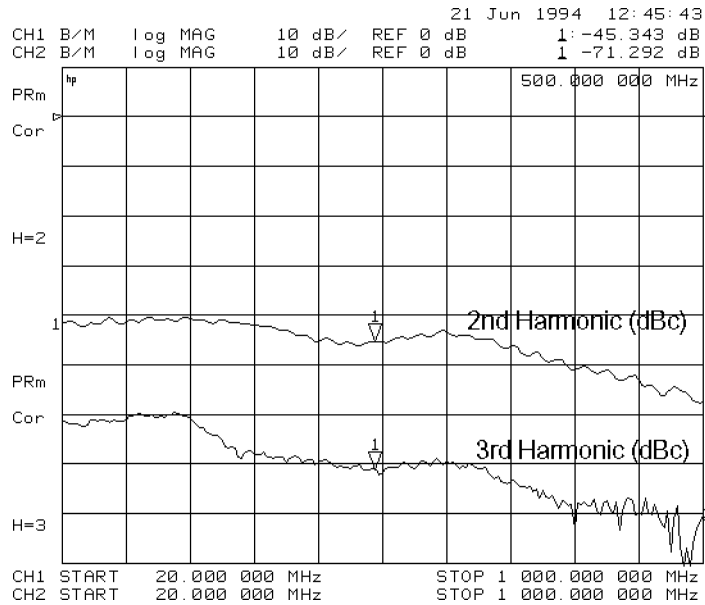

pg6240

Figure 6-83.

Swept Frequency Amplifier Measurement of 2nd and 3rd Harmonic Distortion (dBc)

Gain Compression

Vector network analyzers are commonly used to characterize amplifier gain compression versus frequency and power level. This is essentially linear characterization since only the relative level of the fundamental input to the fundamental output is measured. The narrowband receiver is tuned to a precise frequency and, as a result, is immune from harmonic distortion. You may want to quantify the harmonic distortion itself.

Gain compression occurs when the input power of an amplifier is increased to a level that reduces the gain of the amplifier and causes a nonlinear increase in output power. The point at which the gain is reduced by 1 dB is called the 1 dB compression point. The gain compression will vary with frequency, so it is necessary to find the worst case point of gain compression in the frequency band.

Once that point is identified, you can perform a power sweep of that CW frequency to measure the input power at which the 1 dB compression occurs and the absolute power out (in dBm) at compression.

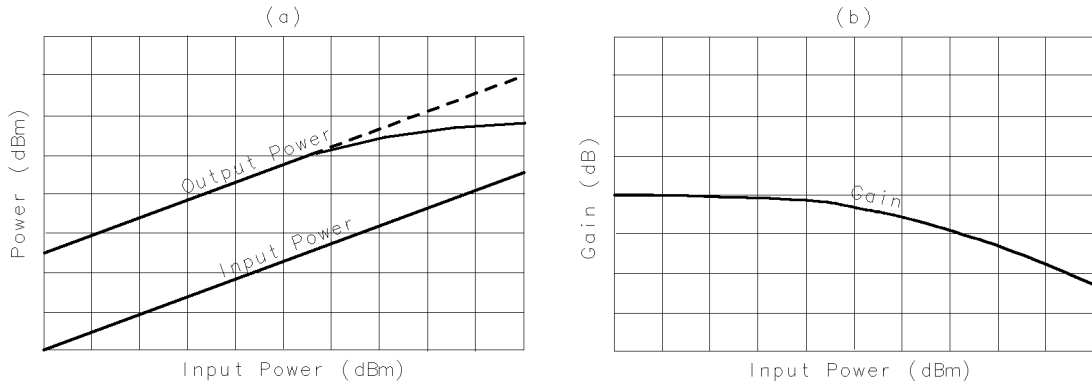

pb697d

Figure 6-84. Diagram of Gain Compression

Figure 6-85 illustrates a simultaneous measurement of fundamental gain compression and second harmonic power as a function of input power.

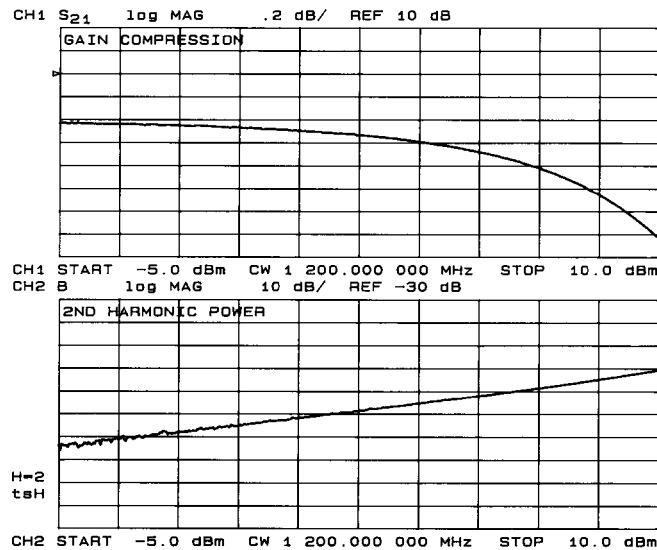

pg6164_c

Figure 6-85. Swept Power Measurement of Amplifier's Fundamental Gain Compression and 2nd Harmonic Output Level

In a compression measurement it is necessary to know the RF input or output power at a certain level of gain compression. Therefore, both gain and absolute power level need to be accurately characterized. Uncertainty in a gain compression measurement is typically less than 0.05 dB. Also, each input channel of the analyzer is calibrated to display absolute power (typically within +0.5 dBm up to 3 GHz, and +1 dB up to 6 GHz).

Metering the power level

When you are measuring a device that is very sensitive to absolute power level, it is important that you accurately set the power level at either the device input or output. The analyzer is capable of using an external HP-IB power meter and controlling source power directly. Figure 6-86 shows a typical test configuration for setting a precise leveled input power at the device input.

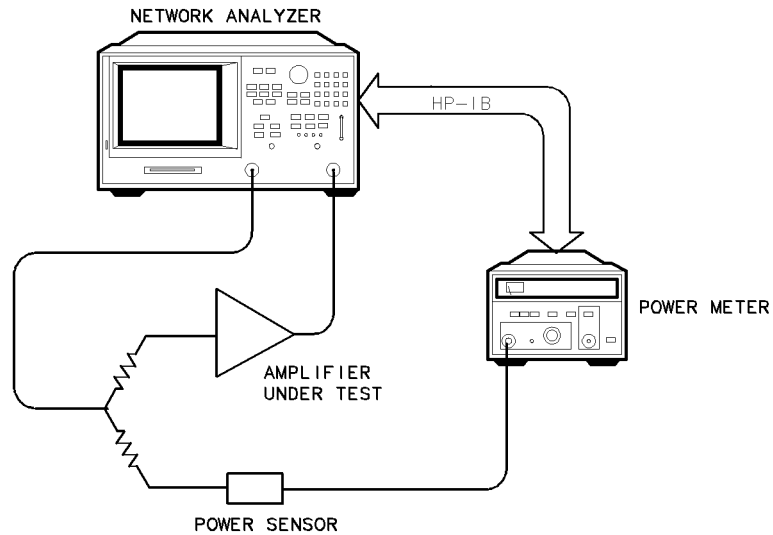

pg6138d

Figure 6-86.
Test Configuration for Setting RF Input using Automatic Power Meter Calibration

Mixer Testing

Mixers or frequency converters, by definition, exhibit the characteristic of having different input and output frequencies. Mixer tests can be performed using the frequency offset operation of the analyzer (with an external LO source) or using the tuned receiver operation of the analyzer (with an external RF and LO source). The most common and convenient method used is frequency offset.

Frequency Offset

For a single-sideband mixer measurement, the RF source can be offset in frequency from the input receiver frequency, allowing for a swept RF stimulus over one frequency range and measurement of the IF response over another (in this case the output IF).

To use the frequency offset guided setup for configuring a mixer measurement:

1. Enter the IF and LO frequencies.
2. Set the LO source to the entered LO frequencies.
3. Specify up conversion or down conversion.
4. Select an RF that is higher or lower in frequency than the LO. (The RF frequencies needed are calculated by the analyzer.)

Tuned Receiver

The analyzer's tuned receiver mode allows you to tune its receiver to an arbitrary frequency and measure signal power. This is only possible if the signal you want to analyze is at an exact known frequency. Therefore, the RF and LO sources must be synthesized and synchronized with the analyzer time base. Since the analyzer is not phaselocking in this configuration, you can use it to measure conversion loss of a microwave mixer with an RF frequency range output.

Note You must take care to filter the output of the mixer because some of the intermodulation and leakage products may be very close in frequency to the desired IF. If these components are not filtered off, the analyzer may have difficulty selecting the correct signal to measure.

Tuned receiver mode also increases dynamic range. Broadband techniques like diode detection have a high noise floor, while narrowband techniques like tuned receivers are much less susceptible to noise.

Mixer Parameters That You Can Measure

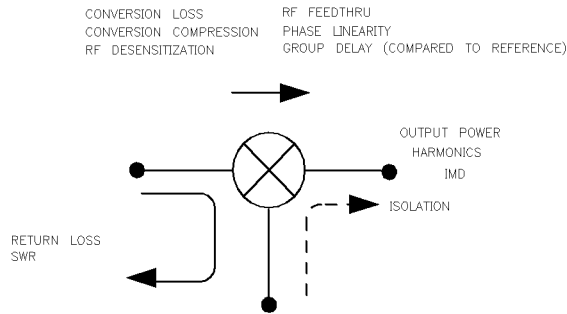

pg6140d

Figure 6-87. Mixer Parameters

- Transmission characteristics include conversion loss, conversion compression, group delay, and RF feedthru.
- Reflection characteristics include return loss, SWR and complex impedance.
- Characteristics of the signal at the output port include the output power, the spurious or harmonic content of the signal, and intermodulation distortion.
- Other parameters of concern are isolation terms, including LO to RF isolation and LO to IF isolation.

Accuracy Considerations

In mixer transmission measurements, you have RF and LO inputs and an IF output. Also emanating from the IF port are several other mixing products of the RF and LO signals. In mixer reflection measurements, leakage signals from one mixer port propagate and appear at the other two mixer ports. These unwanted mixing products or leakage signals can cause distortion by mixing with a harmonic of the analyzer's first down-conversion stage. To ensure that measurement accuracy is not degraded, you must filter certain frequencies or avoid them by frequency selection. If you place attenuators at all mixer ports, you can reduce mismatch uncertainties.

Attenuation at Mixer Ports

Mismatch between the instruments, cables, and mixer introduces errors in the measurement that you cannot remove with a frequency response calibration. You can reduce the mismatch by using high quality attenuators as close to the mixer under test as possible.

When characterizing linear devices, you can use vector accuracy enhancement (measurement calibration) to mathematically remove all systematic errors from the measurement, including source and load mismatches. This is not possible when the device you are characterizing is a mixer operating over multiple frequency ranges: therefore, source and load mismatches are not corrected for and will add to overall measurement uncertainty.

To reduce the measurement errors associated with the interaction between mixer port matches and system port matches, you can place attenuators at all of the mixer's ports. Figure 6-88 shows a plot of swept conversion loss where no attenuation at mixer ports was used. The ripple versus frequency is due to source and load mismatches.

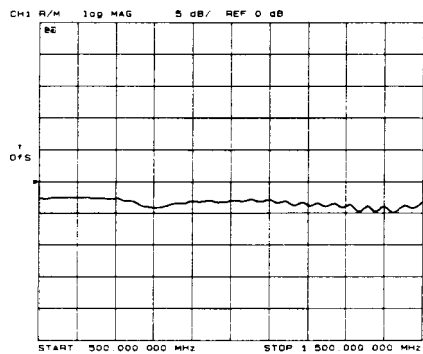

pg6162_c

Figure 6-88.
Conversion Loss versus Output Frequency Without Attenuators at Mixer Ports

In contrast, Figure 6-90 made use of appropriate attenuation at all mixer ports. You should give extra care to the selection of the attenuator located at the mixer's IF port to avoid overdriving the receiver. For best results, choose the value of this attenuator so that the power incident on the analyzer's R channel port is less than -10 dBm and greater than -35 dBm.

Filtering

Harmonics, linearity, and spurious signals also introduce errors that are not removed by frequency response calibration. These errors are smaller with a narrowband detection scheme, but they may still interfere with your measurements. You should filter the IF signal to reduce these errors as much as possible.

Correct filtering between the mixer's IF port and the receiver's input port can eliminate unwanted mixing and leakage signals from entering the analyzer's receiver. Figure 6-89 shows a plot of mixer conversion loss when proper IF filtering was neglected.

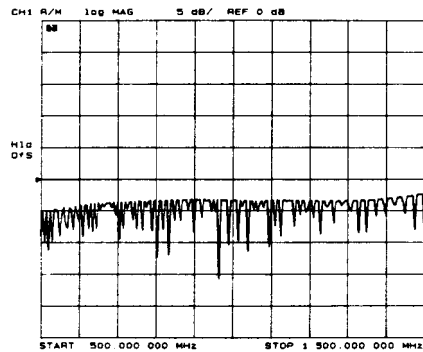

pg6160_c

Figure 6-89.
Example of Conversion Loss versus Output Frequency Without Correct IF Signal Path Filtering

Figure 6-90 shows the same mixer's conversion loss with the addition of a low pass filter at the mixer's IF port.

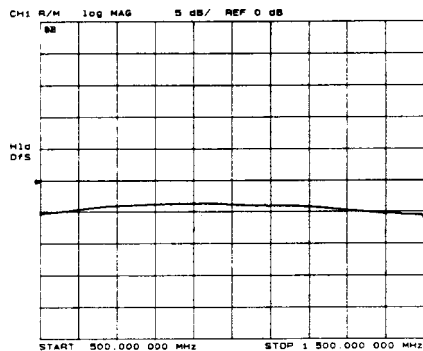

pg6161_c

Figure 6-90.
Example of Conversion Loss versus Output Frequency With Correct IF Signal Path Filtering and Attenuation at all Mixer Ports

Filtering is required in both fixed and broadband measurements, but you can implement it more easily in the fixed situation. Therefore, when configuring broad-band (swept) measurements, you may need to trade some measurement bandwidth for the ability to more selectively filter signals entering the analyzer's receiver.

Frequency Selection

By choosing test frequencies (frequency list mode), you can reduce the effect of spurious responses on measurements by avoiding frequencies that produce IF signal path distortion.

LO Frequency Accuracy and Stability

The analyzer source is phaselocked to its receiver through a reference loop. In the frequency offset mode, the mixer under test is inserted in this loop. To ensure that the analyzer phaselocks correctly, it is important that you use an LO source that has frequency accuracy better than ± 1 MHz and residual FM < 20 kHz RMS.

Up-Conversion and Down-Conversion Definition

When you choose between $RF < LO$ and $RF > LO$ in the frequency offset menus, the analyzer determines which direction the internal source must sweep in order to achieve the requested IF frequency. For example, to measure the lower sideband of a mixer, where the RF signal is below the LO ($RF < LO$), the internal source must sweep backwards. See the examples in Figure 6-91.

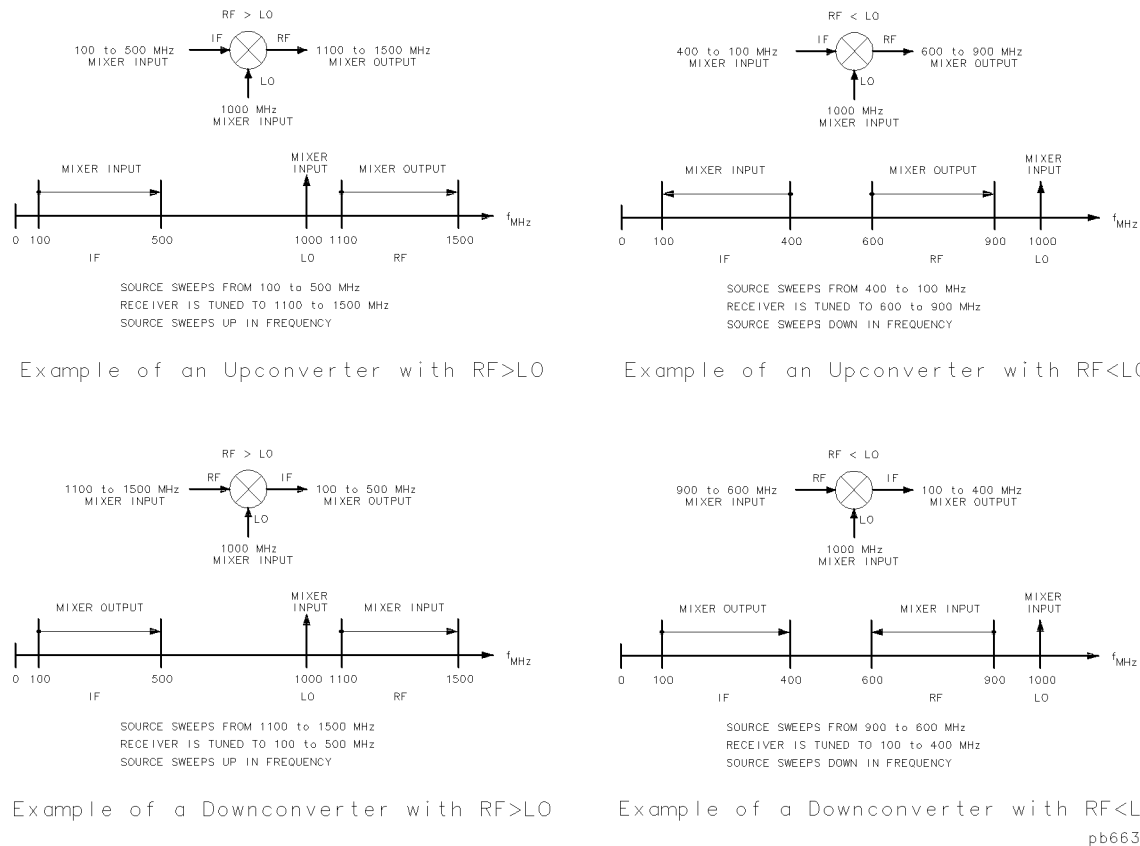

Figure 6-91. Examples of Up Converters and Down Converters

In standard mixer measurements, the input of the mixer is always connected to the analyzer's RF source, and the output of the mixer always produces the IF frequencies that are received by the analyzer's receiver.

However, the ports labeled RF and IF on most mixers are not consistently connected to the analyzer's source and receiver ports, respectively. These mixer ports are switched, depending on whether a down converter or an upconverter measurement is being performed.

It is important to keep in mind that in the setup diagrams of the frequency offset mode, the analyzer's source and receiver ports are labeled according to the mixer port that they are connected to.

- In a down converter measurement where the **DOWN CONVERTER** softkey is selected, the notation on the analyzer's setup diagram indicates that the analyzer's source frequency is labeled RF, connecting to the mixer RF port, and the analyzer's receiver frequency is labeled IF, connecting to the mixer IF port.

Because the RF frequency can be greater or less than the set LO frequency in this type of measurement, you can select either **RF > LO** or **RF < LO**.

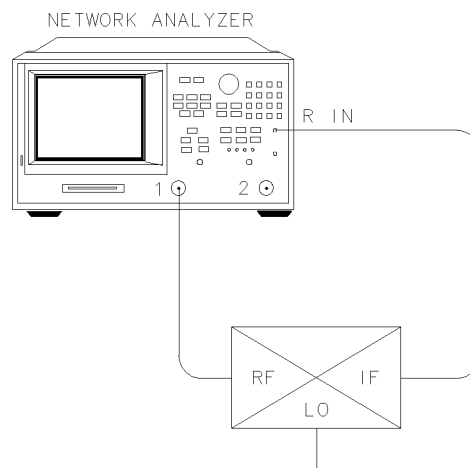

pg6243d

Figure 6-92. Down Converter Port Connections

- In an up converter measurement where the **UP CONVERTER** softkey is selected, the notation on the setup diagram indicates that the analyzer's source frequency is labeled IF, connecting to the mixer IF port, and the analyzer's receiver frequency is labeled RF, connecting to the mixer RF port.

Because the RF frequency will always be greater than the set LO frequency in this type of measurement, you *must select only* **RF > LO**.

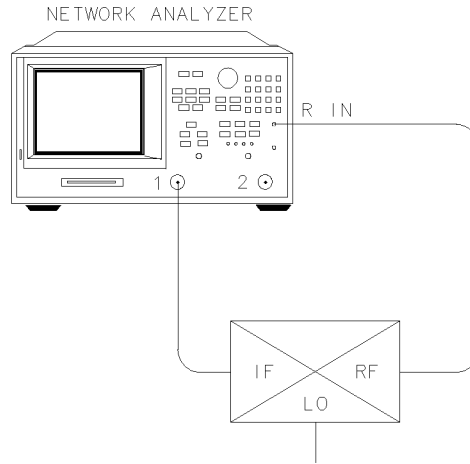

pg6244d

Figure 6-93. Up Converter Port Connections

Conversion Loss

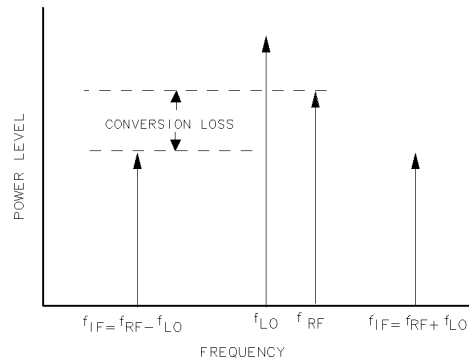

pg694d

Figure 6-94.

Example Spectrum of RF, LO, and IF Signals Present in a Conversion Loss Measurement

Conversion loss is a measure of how efficiently a mixer converts energy from one frequency to another. It is the ratio of the sideband output power to input signal power and is usually expressed in dB.

Since the frequency response of the test system gets measured with the mixer's response, you can perform a frequency response calibration to remove this group of errors.

Isolation

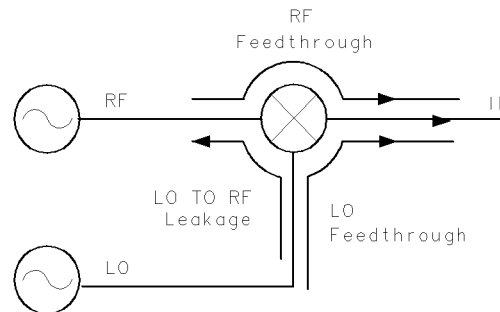

pg6105d

Figure 6-95. Main Isolation Terms

Isolation is the amount of attenuation provided when a signal is applied to one port of a mixer and measured at another port. Figure 6-95 shows the three main isolation terms.

LO Feedthru / LO to RF Leakage

LO feedthru, or LO-to-IF isolation, is the amount the LO signal that is attenuated when it reaches the IF port.

LO to RF isolation is the amount the LO power is attenuated when it appears directly at the RF port.

Both of these LO isolation terms are small for single and double balanced mixers. The RF signal level applied to the mixer will have an affect on this measurement. For this reason, these terms are usually measured with the RF port of the mixer terminated in a matched state.

RF Feedthru

RF feedthru, or RF-to-IF isolation, is the amount the RF power that is attenuated when it reaches the IF port. This value is low in double balanced mixers. RF feedthru is usually less of a problem than the LO isolation terms because the LO power level is significantly higher than the RF power drive.

You can make an RF feedthru measurement using the same instruments and setup that you use to measure conversion loss. Because the source and receiver frequencies are the same, the analyzer can use narrowband (tuned receiver) detection to make the measurement. The only difference that you need in the hardware configuration is that the IF filter needs to be removed so the RF feedthru will not be filtered out.

The RF signal is applied to the RF port of the mixer and the feedthru is measured at the IF port.

The RF feedthru level is very dependent on the LO signal that is applied. For this reason, you should make the measurement with the LO signal present at its normal operating level.

You should perform a frequency response calibration to improve accuracy.

SWR / Return Loss

Reflection coefficient (Γ) is defined as the ratio between the reflected voltage (V_r) and incident voltage (V_i). Standing wave ratio (SWR) is defined as the ratio of maximum standing wave voltage to the minimum standing wave voltage and can be derived from the reflection coefficient (Γ) using the equation shown below. Return loss can be derived from the reflection coefficient as well.

$$\Gamma = \frac{V_r}{V_i}$$
$$SWR = \frac{1 + |\Gamma|}{1 - |\Gamma|}$$

$$\text{Return loss} = -20 \log |\Gamma|$$

Note

Mixers are three-port devices, and the reflection from any one port depends on the conditions of the other two ports. You should replicate the operating conditions the mixer will experience as closely as possible for the measurement.

When you measure the RF port SWR, you should have the LO drive level present and set to the expected frequency and power levels. The IF port should be terminated in a condition as close to its operating state as possible.

The measurements of LO port SWR and IF port SWR are very similar. For IF port SWR, you should terminate the RF port in a matched condition and apply the LO signal at its normal operating level. For the LO port SWR, the RF and IF ports should both be terminated in conditions similar to what will be present during normal operation.

Conversion Compression

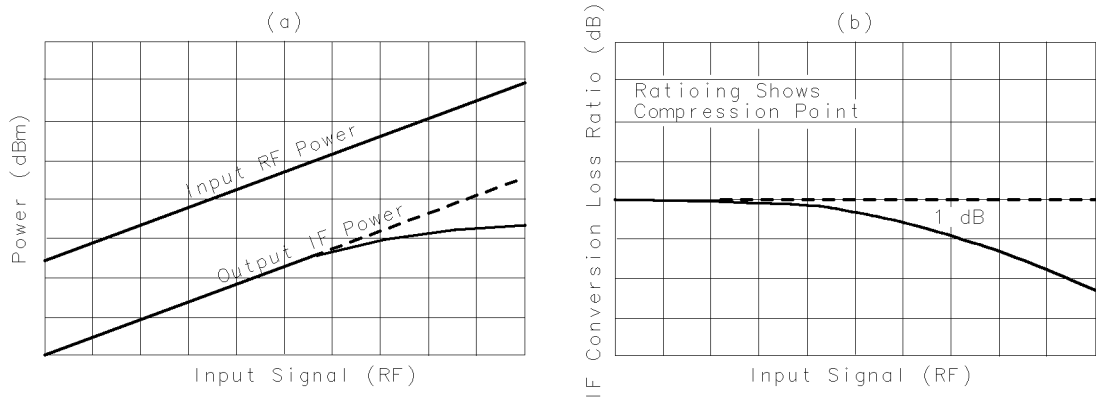

Figure 6-96. Conversion Loss and Output Power as a Function of Input Power Level

Conversion compression is a measure of the maximum RF input signal level for which the mixer will provide linear operation. The conversion loss is the ratio of the IF output level to the RF input level, and this value remains constant over a specified input power range. When the input power level exceeds a certain maximum, the constant ratio between IF and RF power levels will begin to change. The point at which the ratio has decreased 1 dB is called the 1 dB compression point.

Notice in Figure 6-96 that the output power increases linearly with the increasing input signal level, until mixer compression begins and the mixer saturates.

You can measure conversion compression using the same basic test configurations that are used to measure the conversion loss.

To set up for a conversion compression measurement, first measure the conversion loss of the mixer under test. Set up for a CW measurement at the frequency of interest. Sweeping the RF drive level over a 25 dB span soon shows the power level at which the conversion loss increases by 1 dB.

With power meter calibration controlling the RF drive level, and the receiver calibrated to measure output power, you can make accurate measurements of the output power at the 1 dB compression point.

Phase Measurements

When you are making linear measurements, provide a reference for determining phase by splitting the RF source power and send part of the signal into the reference channel. (This does not work for frequency offset measurements, since the source and receiver are functioning at different frequencies.)

To provide a reference signal for the phase measurement, you need a second mixer. This mixer is driven by the same RF and LO signals that are used to drive the mixer under test. The IF output from the reference mixer is applied to the reference (R) channel of the analyzer.

Amplitude and Phase Tracking

The match between mixers is defined as the absolute difference in amplitude and/or phase response over a specified frequency range. The tracking between mixers is essentially how well the devices are matched over a specified interval. This interval may be a frequency interval or a temperature interval, or a combination of both.

You can make tracking measurements by ratioing the responses of two mixer conversion loss measurements. Then any difference you view in response is due to the mixers and not the measurement system.

Replace mixer A with the mixer that you want to compare it to. Mixer R should always remain in place as the reference mixer.

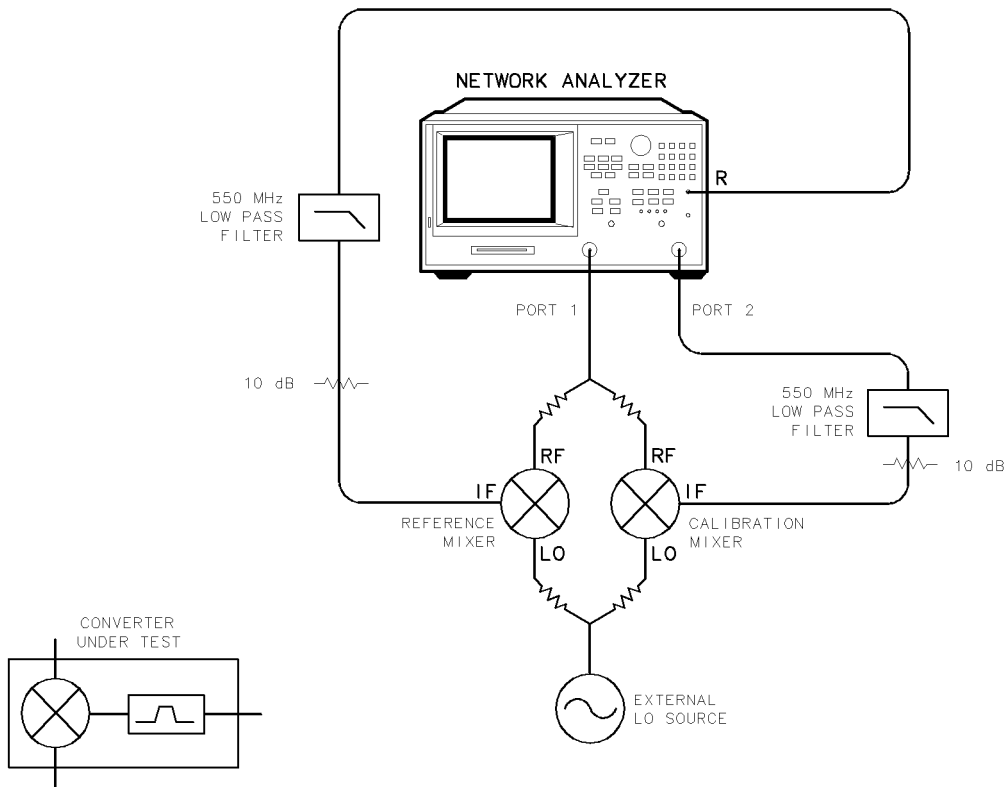

Figure 6-97.

Connections for an Amplitude and Phase Tracking Measurement Between Two Mixers

Phase Linearity and Group Delay

Group delay is the rate of change of phase through a device with respect to frequency ($d\phi/d\omega$). Traditionally, group delay has been used to describe the propagation delay (τ_g), and deviation from linear phase through a linear device. However, this parameter also contains valuable information about transmission delay and distortion through a non-linear device such as a mixer or frequency converter. For example, flat group delay corresponds to low modulation distortion (that is, carrier and sidebands propagate at the same rate).

Phase linearity and group delay are both measurements of the distortion of a transmitted signal. Both measure the non-linearity of a device's phase response with respect to frequency.

In standard vector error-correction, a thru (delay=0) is used as a calibration standard. The solution to this problem is to use a calibration mixer with very small group delay as the calibration standard.

An important characteristic to remember when selecting a calibration mixer is that the delay of the device should be kept as low as possible. To do this, select a mixer with very wide bandwidth (wider bandwidth results in smaller delay).

Connection Considerations

Adapters

To minimize the error introduced when you add an adapter to a measurement system, the adapter needs to have low SWR or mismatch, low loss, and high repeatability.

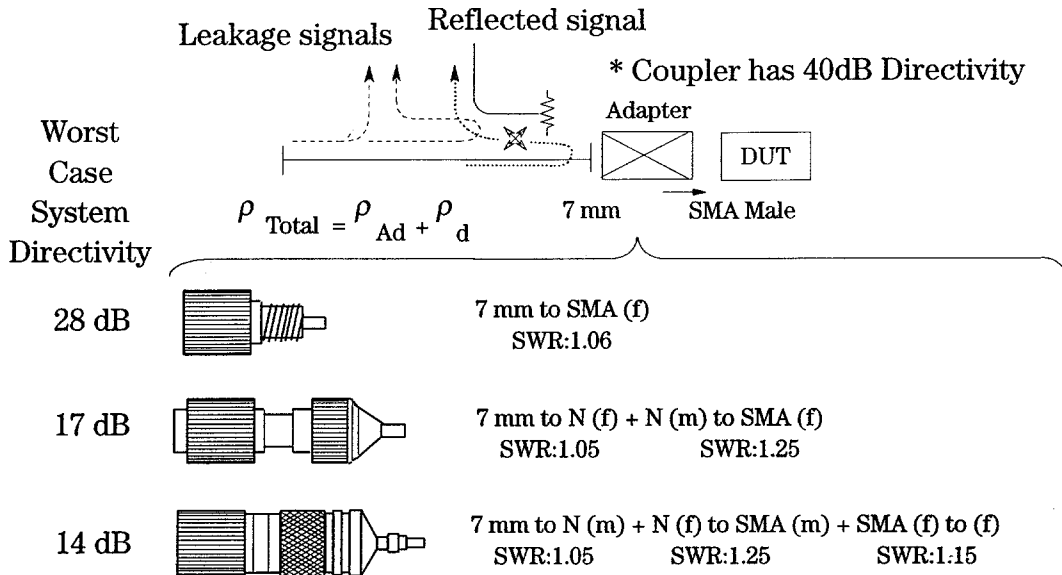

pg6237

Figure 6-98. Adapter Considerations

In a reflection measurement, the directivity of a system is a measure of the error introduced by an imperfect signal separation device. It typically includes any signal that is detected at the coupled port which has not been reflected by the test device. This directivity error will add with the true reflected signal from the device, causing an error in the measured data. Overall directivity is the limit to which a device's return loss or reflection can be measured. Therefore, it is important to have good directivity to measure low reflection devices.

For example, a coupler has a 7 mm connector and 40 dB directivity, which is equivalent to a reflection coefficient of $\rho=0.01$ (directivity in dB = $-20 \log \rho$). Suppose we want to connect to a device with an SMA male connector. We need to adapt from 7 mm to SMA.

If we choose a precision 7 mm to SMA adapter with a SWR of 1.06, which has $\rho=0.03$, the overall directivity becomes $\rho=0.04$ or 28 dB. However, if we use two adapters to do the same job, the reflection from each adapter adds up to degrade the directivity to 17 dB. The last example shown in Figure 6-98 uses three adapters that shows an even worse directivity of 14 dB. It is clear that a low SWR is desirable to avoid degrading the directivity of the system.

Fixtures

Fixtures are needed to interface non-coaxial devices to coaxial test instruments. It may also be necessary to transform the characteristic impedance from standard 50 ohm instruments to a non-standard impedance and to apply bias if an active device is being measured.

For accurate measurements, the fixture must introduce minimum change to the test signal, not destroy the test device, and provide a repeatable connection to the device.

Hewlett-Packard offers several fixtures for TO cans, stripline, and microstrip devices. Refer to Chapter 11, "Compatible Peripherals."

If You Want to Design Your Own Fixture

Ideally, a fixture should provide a transparent connection between the test instrument and the test device. This means it should have no loss or electrical length and a flat frequency response, to prevent distortion of the actual signal. A perfect match to both the instrument and the test device eliminates reflected test signals. The signal should be effectively coupled into the test device, rather than leaking around the device and resulting in crosstalk from input to output. Repeatable connections are necessary to ensure consistent data.

Realistically, it is impossible to build an ideal fixture, especially at high frequencies. However, it is possible to optimize the performance of the test fixture relative to the performance of the test device. If the fixture's effects on the test signal are relatively small compared to the device's parameters, then the fixture's effects can be assumed to be negligible.

For example, if the fixture's loss is much less than the acceptable measurement uncertainty at the test frequency, then it can be ignored.

Reference Documents

Hewlett-Packard Company, "Simplify Your Amplifier and Mixer Testing" 5956-4363

Hewlett-Packard Company, "RF and Microwave Device Test for the '90s – Seminar Papers" 5091-8804E

Hewlett-Packard Company "Testing Amplifiers and Active Devices with the HP 8720 Network Analyzer" Product Note 8720-1 5091-1942E

Hewlett-Packard Company "Mixer Measurements Using the HP 8753 Network Analyzer" Product Note 8753-2A 5952-2771

General Measurement and Calibration Techniques

Rytting, Doug, "Effects of Uncorrected RF Performance in a Vector Network Analyzer," from "Microwave Journal," April 1991

Blacka, Robert J., "TDR Gated Measurements of Stripline Terminations," Reprint from "Microwave Product Digest," HP publication no. 5952-0359, March/April 1989

Montgomery, David, "Borrowing RF Techniques for Digital Design," Reprint from "Computer Design" HP publication number 5952-9335, May 1982

Rytting, Doug, "Advances in Microwave Error Correction Techniques," Hewlett-Packard RF and Microwave Measurement Symposium paper HP publication number 5954-8378, June 1987

Rytting, Doug, "Improved RF Hardware and Calibration Methods for Network Analyzers," Hewlett-Packard RF and Microwave Measurement Symposium paper, 1991

Dunsmore, Joel, "Add Power-Meter Accuracy to a Network Analyzer," from "Microwaves and RF," January 1991

Fixtures and Non-Coaxial Measurements

Hewlett-Packard Company, "Applying the HP 8510 TRL Calibration for Non-Coaxial Measurements," Product Note 8510-8A HP publication number 5091-3645E, February 1992

Hewlett-Packard Company, "Measuring Chip Capacitors with the HP 8520C Network Analyzers and Inter-Continental Microwave Test Fixtures" Product Note 8510-17 HP publication number 5091-5674E, September 1992

Hewlett-Packard Company, "In-Fixture Microstrip Device Measurement Using TRL* Calibration," Product Note 8720-2 HP publication number 5091-1943E, August 1991

Hewlett-Packard Company, "Calibration and Modeling Using the HP 83040 Modular Microcircuit Package," Product Note 83040-2 HP publication number 5952-1907, May 1990

"Test Fixtures and Calibration Standards," Inter-Continental Microwave Product Catalog HP publication number 5091-4254E

Curran, Jim, "Network Analysis of Fixtured Devices," Hewlett-Packard RF and Microwave Measurement Symposium paper, HP publication number 5954-8346, September 1986

Curran, Jim, "TRL Calibration for Non-Coaxial Measurements," Hewlett-Packard Semiconductor Test Symposium paper

Elmore, Glenn and Louis Salz, "Quality Microwave Measurement of Packaged Active Devices," Hewlett-Packard Journal, February 1987

"Measurement Techniques for Fixtured Devices," HP 8510/8720 News HP publication number 5952-2766, June 1990

On-Wafer Measurements

Hewlett-Packard Company, "On-Wafer Measurements Using the HP 8510 Network Analyzer and Cascade Microtech Wafer Probes," Product Note 8510-6 HP publication number 5954-1579

Barr, J.T., T. Burcham, A.C. Davidson, E.W. Strid, "Advancements in On-Wafer Probing Calibration Techniques," Hewlett-Packard RF and Microwave Measurement Symposium paper, 1991

Lautzenhiser, S., A. Davidson, D. Jones, "Improve Accuracy of On-Wafer Tests Via LRM Calibration," Reprinting from "Microwaves and RF" HP publication number 5952-1286, January 1990

"On-Wafer Calibration: Practical Considerations," HP 8510/8720 News HP publication number 5091-6837, February 1993

Specifications and Measurement Uncertainties

Dynamic Range

The specifications described in the table below apply to transmission measurements using 10 Hz IF BW and full 2-port correction. Dynamic range is limited by the maximum test port power and the receiver's noise floor.

Table 7-1. HP 8753D Dynamic Range

Frequency Range	Dynamic Range
30 kHz to 300 kHz	100 dB [*]
300 kHz to 1.3 GHz	110 dB ^{† ‡}
1.3 GHz to 3 GHz	110 dB [‡]
3 GHz to 6 GHz	105 dB

* 90 dB, 30 kHz to 50 kHz
† 100 dB, 300 kHz to 16 MHz, due to fixed spurs
‡ 105 dB, Option 075

HP 8753D Network Analyzer Specifications

HP 8753D (50Ω) with 7 mm Test Ports

The following specifications describe the system performance of the HP 8753D network analyzer. The system hardware includes the following:

- Options:** 006
- Calibration kit:** HP 85031B
- Cables:** HP 11857D

Measurement Port Characteristics

The following tables describe the measurement port characteristics for both corrected and uncorrected HP 8753D network analyzers.

Table 7-2.
Measurement Port Characteristics (Corrected*) for HP 8753D (50Ω) with 7 mm Test Ports

	Frequency Range			
	30 kHz to 300 kHz†	300 kHz to 1.3 GHz	1.3 GHz to 3 GHz	3 GHz to 6 GHz
Directivity	55 dB	55 dB	51 dB	46 dB
Source match	55 dB	51 dB	49 dB	43 dB
Load match	55 dB	55 dB	51 dB	46 dB
Reflection tracking	±0.001 dB	±0.001 dB	±0.005 dB	±0.020 dB
Transmission tracking	±0.008 dB	±0.006 dB	±0.009 dB	±0.021 dB

* These characteristics apply for an environmental temperature of 25 ± 5 °C, with less than 1 °C deviation from the calibration temperature.
† Typical Performance

Table 7-3.
Measurement Port Characteristics (Uncorrected*) for HP 8753D (50Ω) with 7 mm Test Ports

	Frequency Range			
	30 kHz to 300 kHz†	300 kHz to 1.3 GHz	1.3 GHz to 3 GHz	3 GHz to 6 GHz
Directivity	20 dB‡	35 dB	30 dB	25 dB
Source match	18 dB§	16 dB	16 dB	14 dB
Load match	20 dB§	18 dB	16 dB	14 dB
Reflection tracking	±2.0 dB	±1.5 dB	±1.5 dB	±2.5 dB
Transmission tracking	±2.0 dB	±1.5 dB	±1.5 dB	±2.5 dB
Crosstalk	100 dB	100 dB	100 dB	90 dB

* Applies at 25 ± 5 °C
† Typical
§ 10 dB, 30 kHz to 50 kHz
‡ 15 dB, 30 kHz to 50 kHz

Transmission Measurement Uncertainties

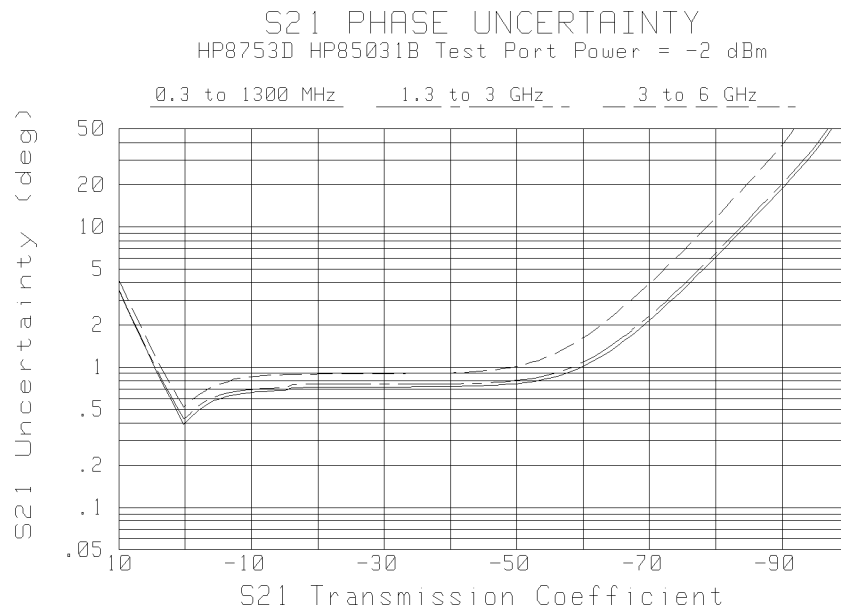
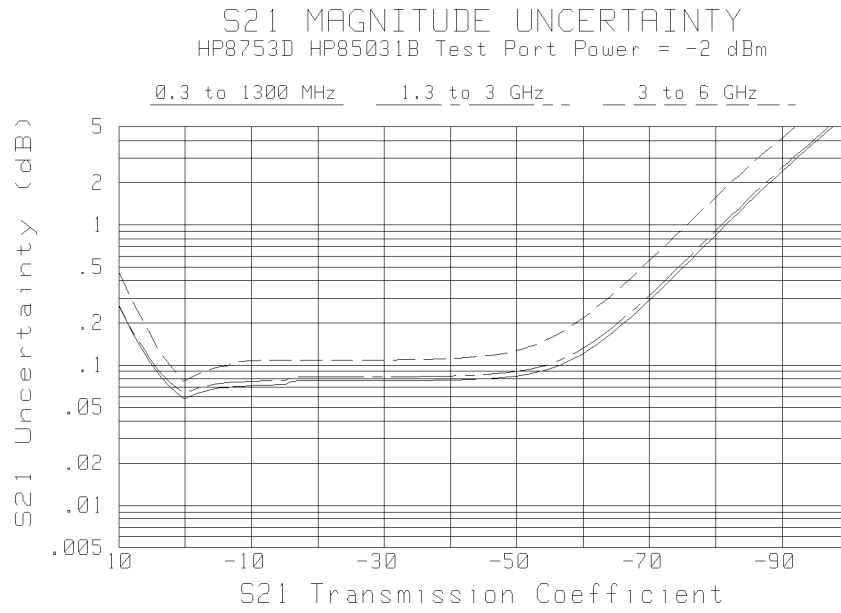

Reflection Measurement Uncertainties

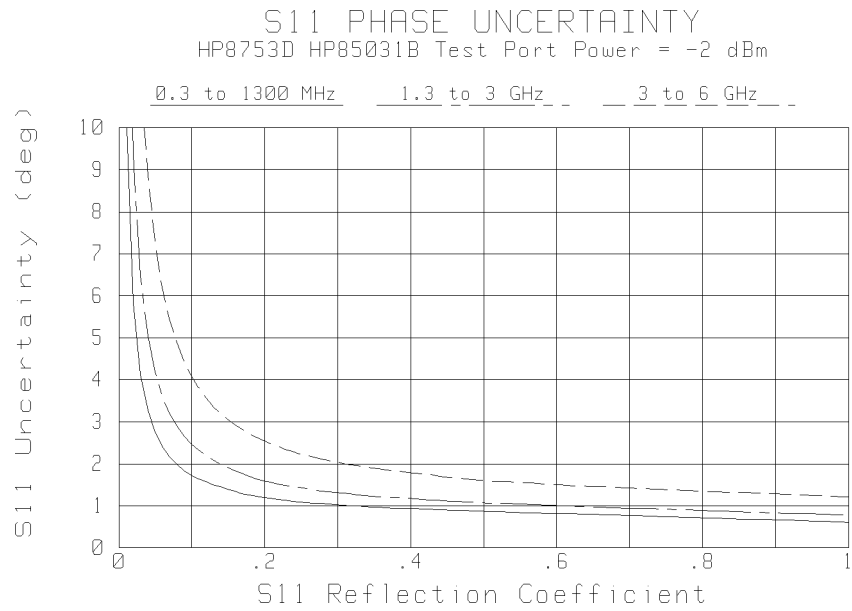
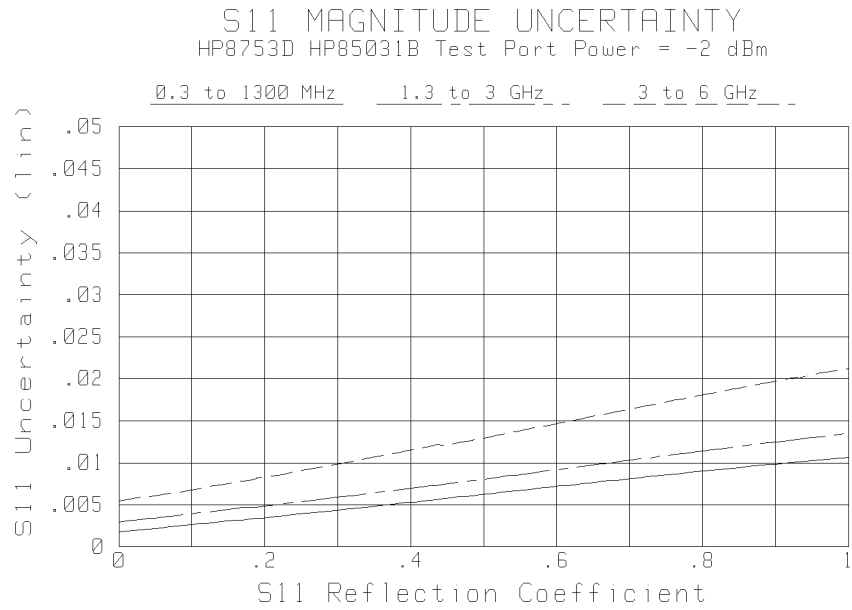

HP 8753D (50Ω) with Type-N Test Ports

The following specifications describe the system performance of the HP 8753D network analyzer. The system hardware includes the following:

Options:	006
Calibration kit:	HP 85032B/E
Cables:	HP 11851B

Measurement Port Characteristics

The following table describes the measurement port characteristics for corrected HP 8753D network analyzers.

Table 7-4.
Measurement Port Characteristics (Corrected)* for HP 8753D (50Ω) with Type-N Test Ports

	Frequency Range			
	30 kHz to 300 kHz [†]	300 kHz to 1.3 GHz	1.3 GHz to 3 GHz	3 GHz to 6 GHz
Directivity	50 dB	50 dB	47 dB	40 dB
Source match	49 dB	42 dB	36 dB	31 dB
Load match	50 dB	50 dB	47 dB	40 dB
Reflection tracking	±0.005 dB	±0.009 dB	±0.019 dB	±0.070 dB
Transmission tracking	±0.014 dB	±0.013 dB	±0.026 dB	±0.065 dB
* Applies at 25 ± 5 °C				
† Typical performance				

Transmission Measurement Uncertainties

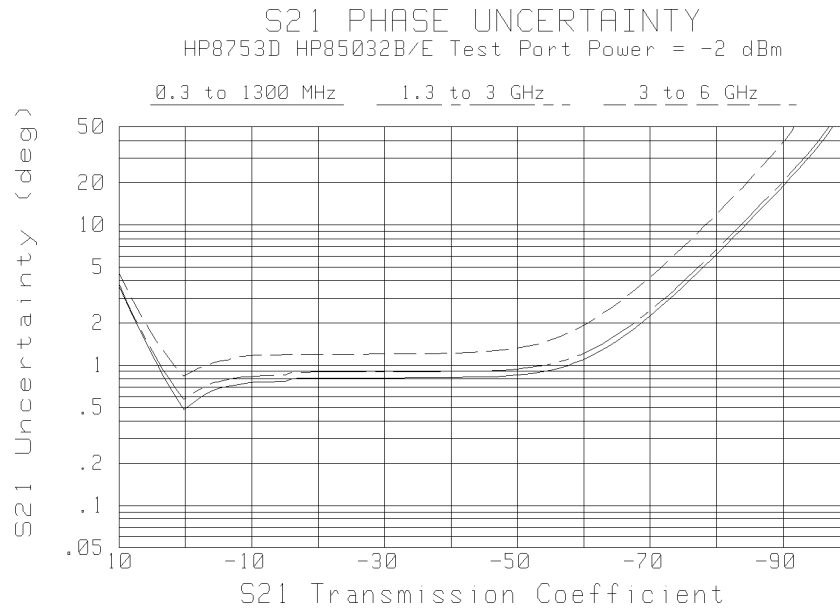
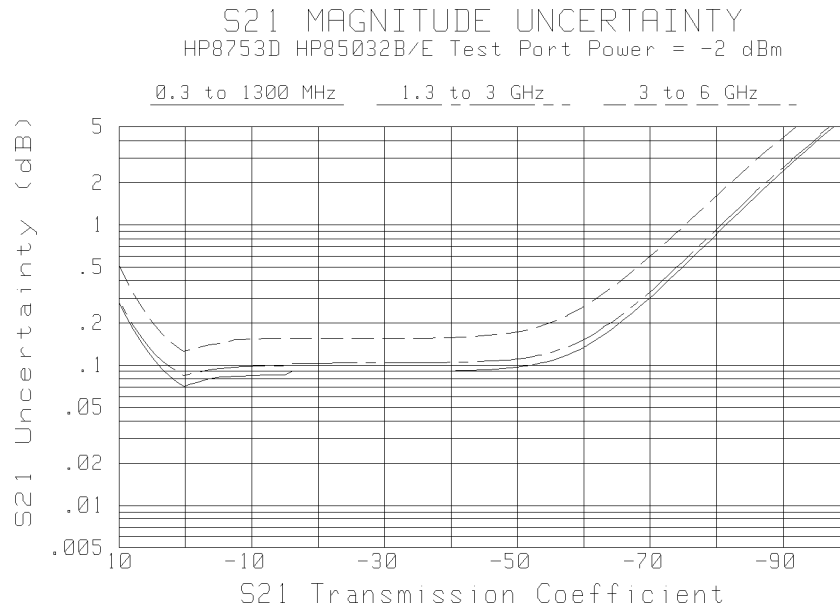

Reflection Measurement Uncertainties

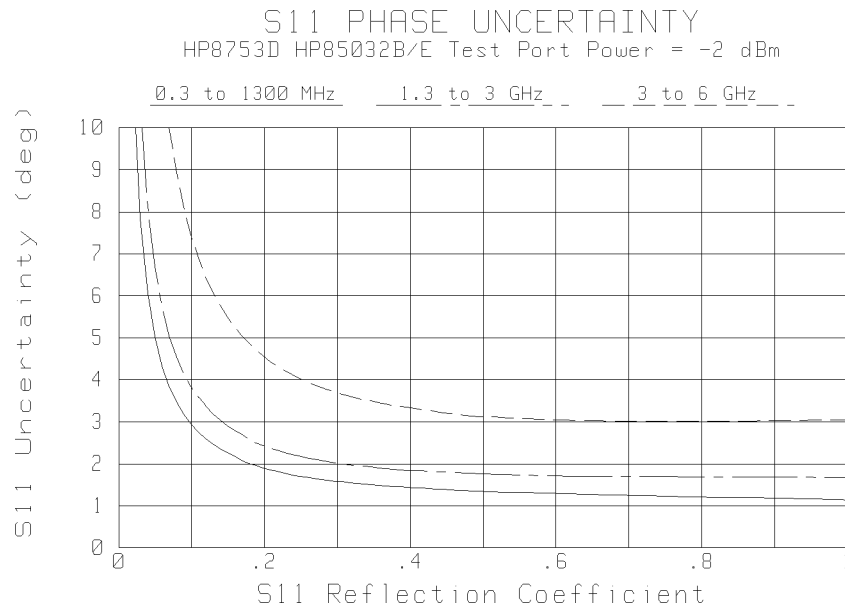
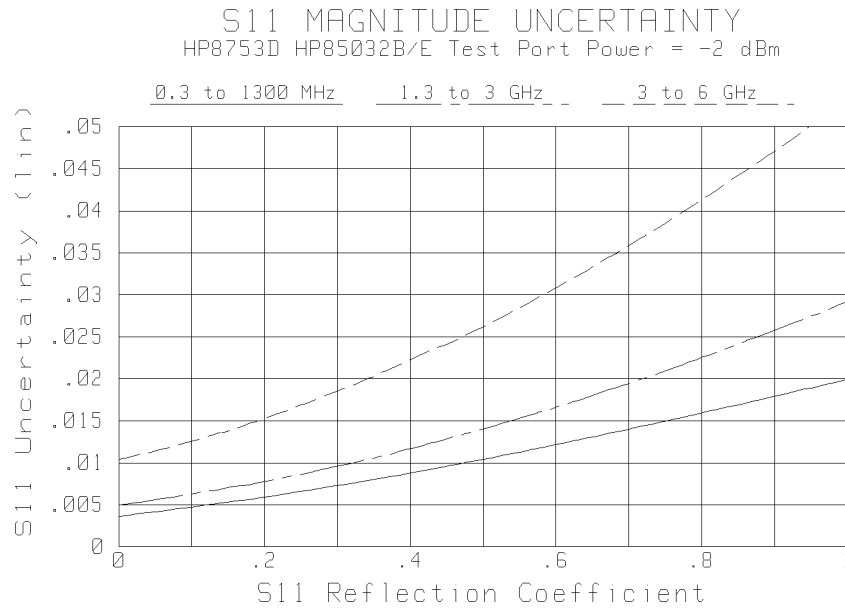

HP 8753D (50Ω) with 3.5 mm Test Ports

The following specifications describe the system performance of the HP 8753D network analyzer. The system hardware includes the following:

Options:	006
Calibration kit:	HP 85033D
Cables:	HP 11857D

Measurement Port Characteristics

The following table describes the measurement port characteristics for corrected HP 8753D network analyzers.

Table 7-5.
Measurement Port Characteristics (Corrected)* for HP 8753D (50Ω) with 3.5 mm Test Ports

	Frequency Range			
	30 kHz to 300 kHz [†]	300 kHz to 1.3 GHz	1.3 GHz to 3 GHz	3 GHz to 6 GHz
Directivity	49 dB	46 dB	44 dB	38 dB
Source match	49 dB	44 dB	41 dB	37 dB
Load match	49 dB	46 dB	44 dB	38 dB
Reflection tracking	±0.010 dB	±0.005 dB	±0.007 dB	±0.009 dB
Transmission tracking	±0.016 dB	±0.014 dB	±0.022 dB	±0.048 dB
* Applies at 25 ± 5 °C				
† Typical Performance				

Transmission Measurement Uncertainties

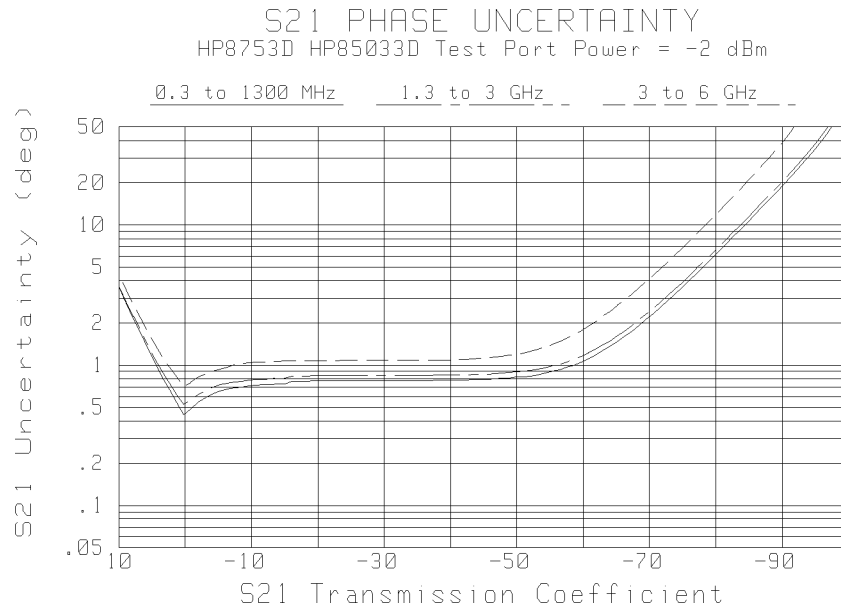
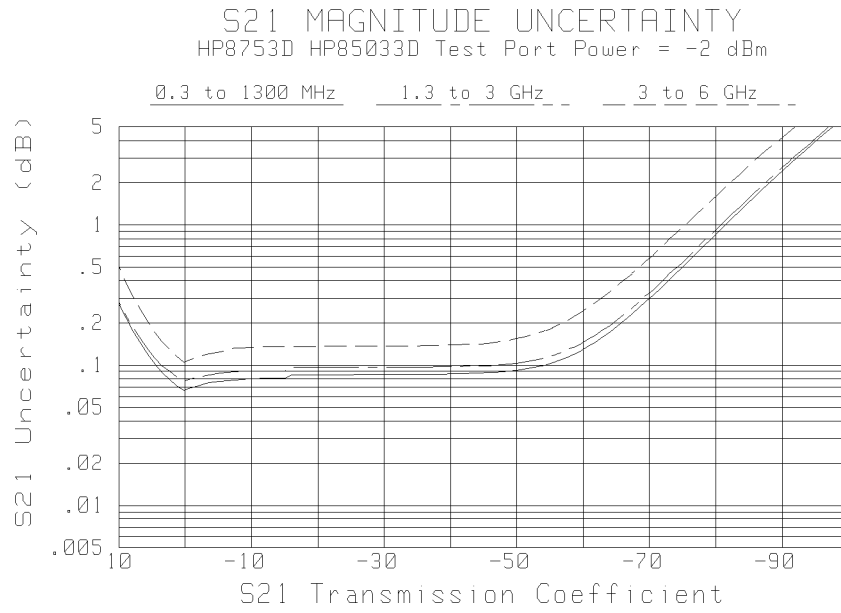

Reflection Measurement Uncertainties

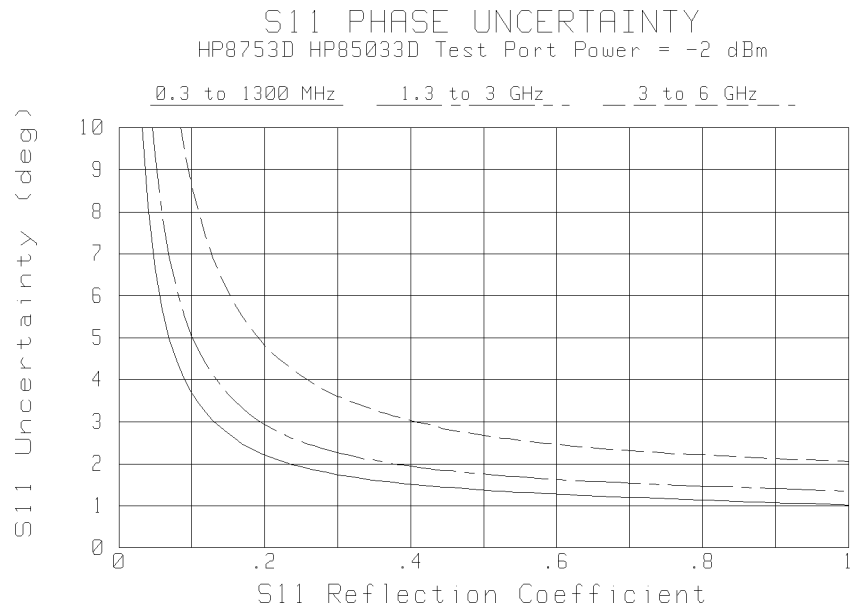
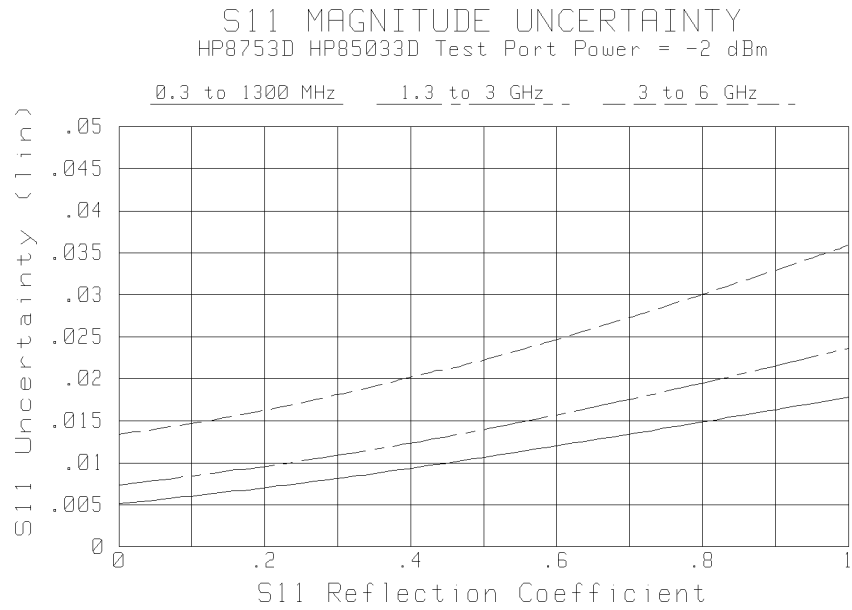

HP 8753D (75Ω) with Type-N Test Ports

The following specifications describe the system performance of the HP 8753D network analyzer. The system hardware includes the following:

Options:	075
Calibration kit:	HP 85036B
Cables:	HP 11857B

Measurement Port Characteristics

The following tables describe the measurement port characteristics for both corrected and uncorrected HP 8753D network analyzers.

Table 7-6.
Measurement Port Characteristics (Corrected)* for HP 8753D (75Ω) with Type-N Test Ports

	Frequency Range		
	30 kHz to 300 kHz [†]	300 kHz to 1.3 GHz	1.3 GHz to 3 GHz
Directivity	48 dB	48 dB	43 dB
Source match	47 dB	41 dB	35 dB
Load match	48 dB	48 dB	43 dB
Reflection tracking	±0.004 dB	±0.010 dB	±0.019 dB
Transmission tracking	±0.018 dB	±0.015 dB	±0.033 dB
* Applies at 25 ± 5 °C			
† Typical Performance			

Table 7-7.
Measurement Port Characteristics (Uncorrected)*[†] for HP 8753D (75Ω) with Type-N Test Ports

	Frequency Range		
	30 kHz to 300 kHz [†]	300 kHz to 1.3 GHz	1.3 GHz to 3 GHz
Directivity	34 dB	35 dB	30 dB
Source match	10 dB	16 dB	16 dB
Load match	14 dB	18 dB	16 dB
Reflection tracking	±2.0 dB	±1.5 dB	±1.5 dB
Transmission tracking	±2.0 dB	±1.5 dB	±1.5 dB
Crosstalk	100 dB	100 dB	100 dB
* Applies at 25 ± 5 °C			
† Typical Performance			

Transmission Measurement Uncertainties

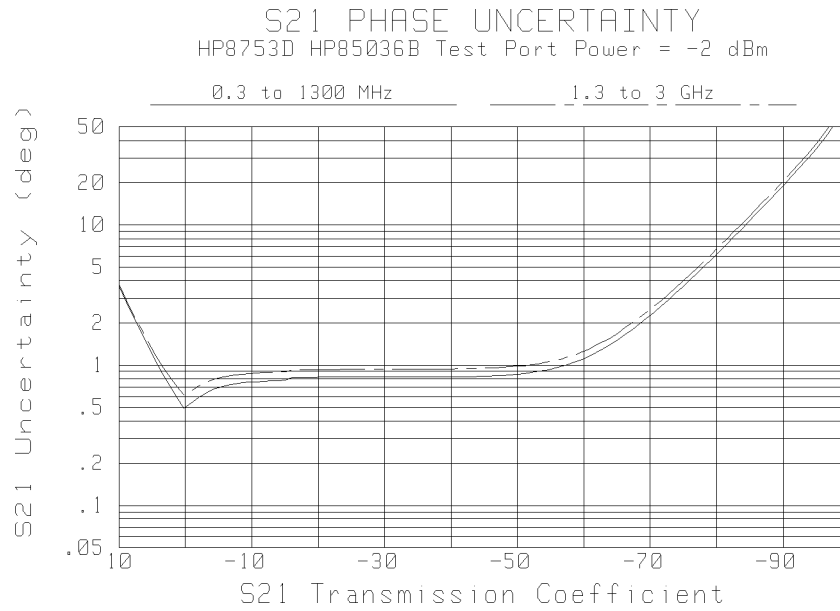
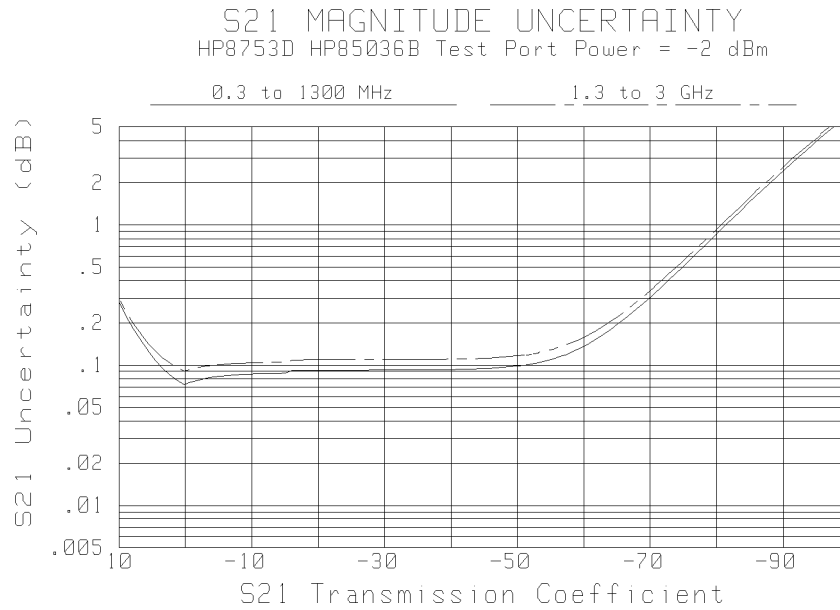

Reflection Measurement Uncertainties

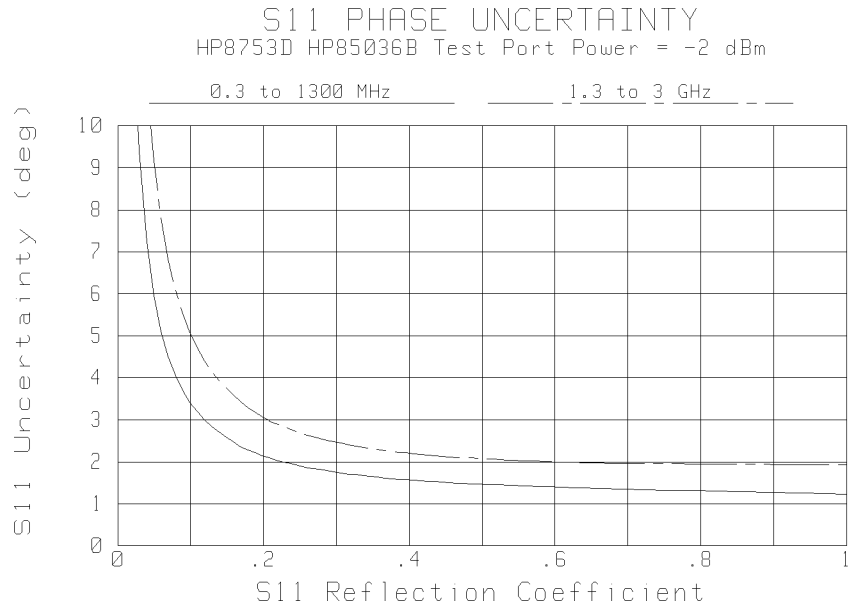
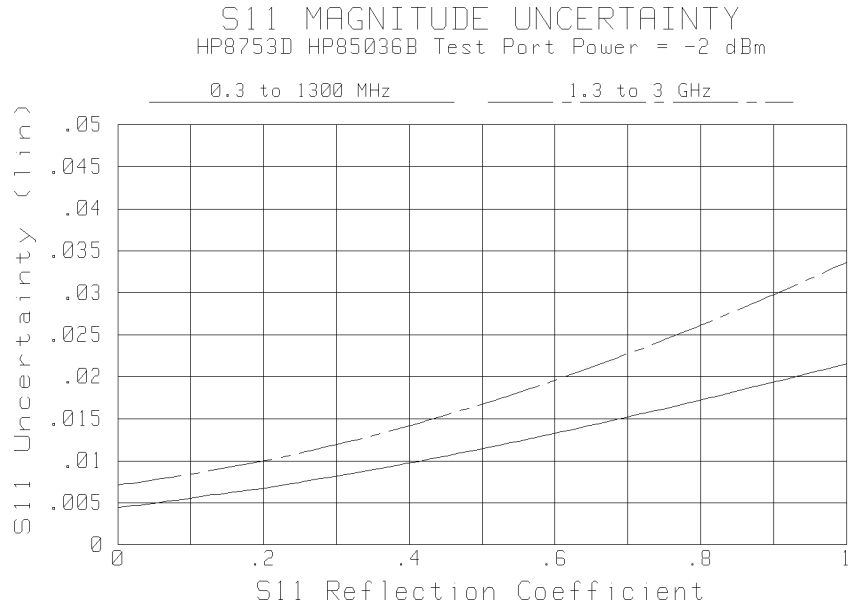

HP 8753D (75Ω) with Type-F Test Ports

The following specifications describe the system performance of the HP 8753D network analyzer. The system hardware includes the following:

Options:	075
Calibration kit:	HP 85039A
Cables:	HP 11857B

Measurement Port Characteristics

The following table describes the measurement port characteristics for corrected HP 8753D network analyzers.

Table 7-8.
Measurement Port Characteristics (Corrected)* for HP 8753D (75Ω)
using HP 85039A F-M Test Ports

	Frequency Range		
	30 kHz to 300 kHz [†]	300 kHz to 1.3 GHz	1.3 GHz to 3 GHz
Directivity	38 dB	38 dB	32 dB
Source match	36 dB	36 dB	30 dB
Load match	38 dB	38 dB	32 dB
Reflection tracking	±0.0080 dB	±0.0080 dB	±0.0320 dB
Transmission tracking	±0.0618 dB	±0.0346 dB	±0.0778 dB
* Applies at 25 ±5 °C			
† Typical Performance			

Transmission Measurement Uncertainties

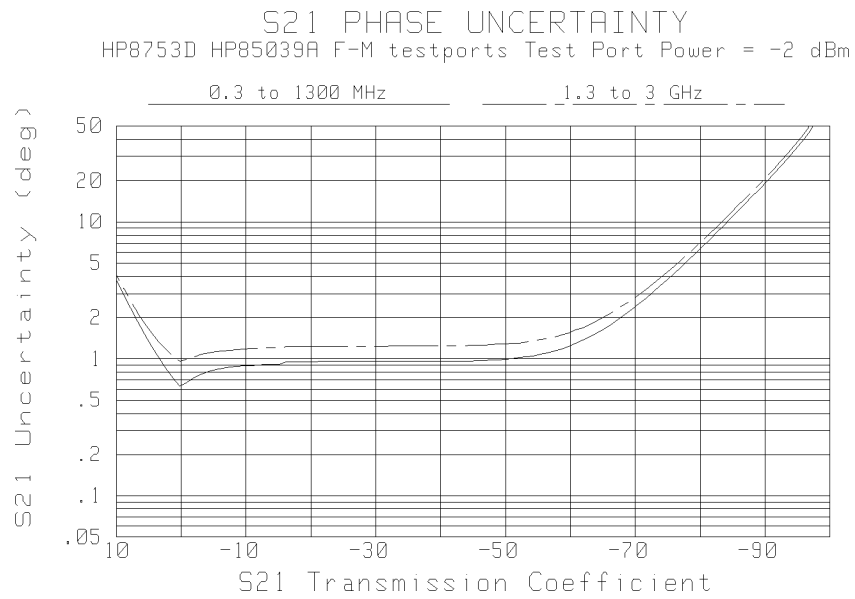
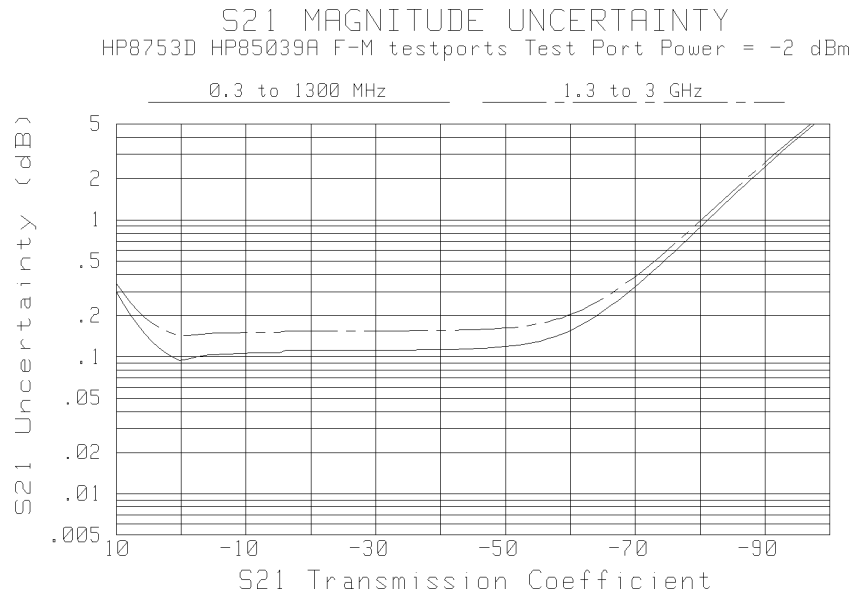

Reflection Measurement Uncertainties

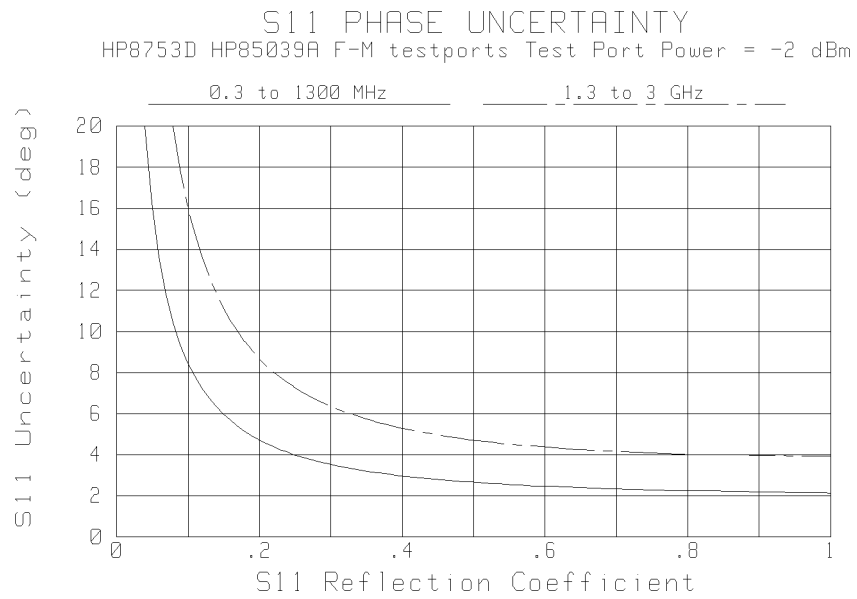
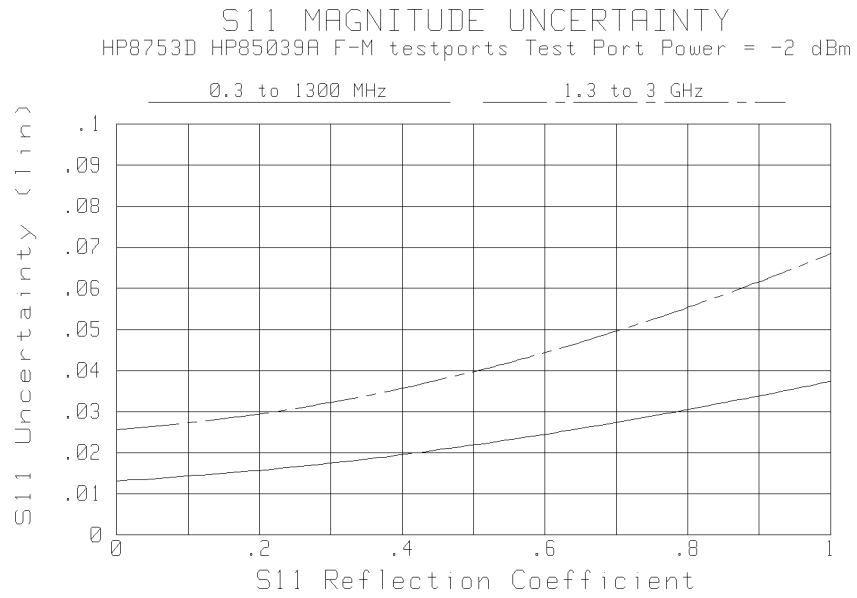
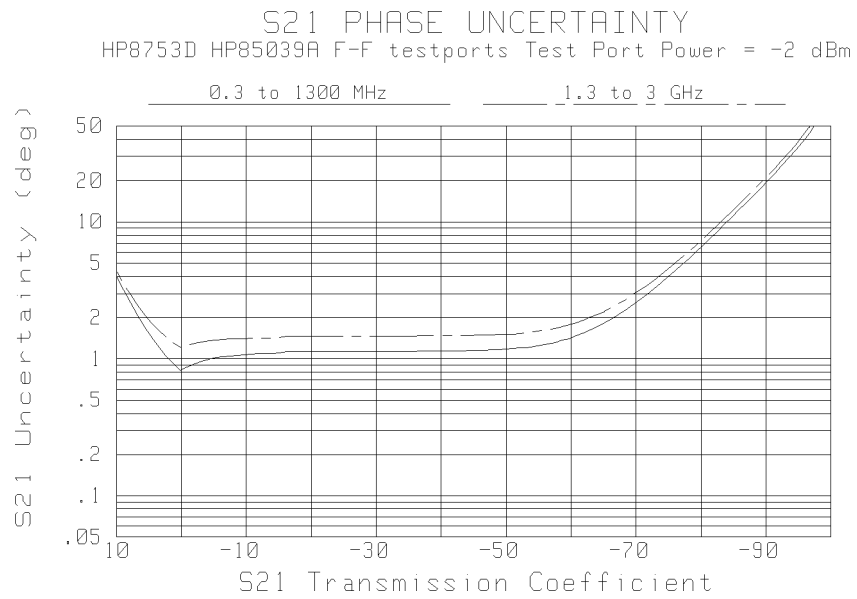
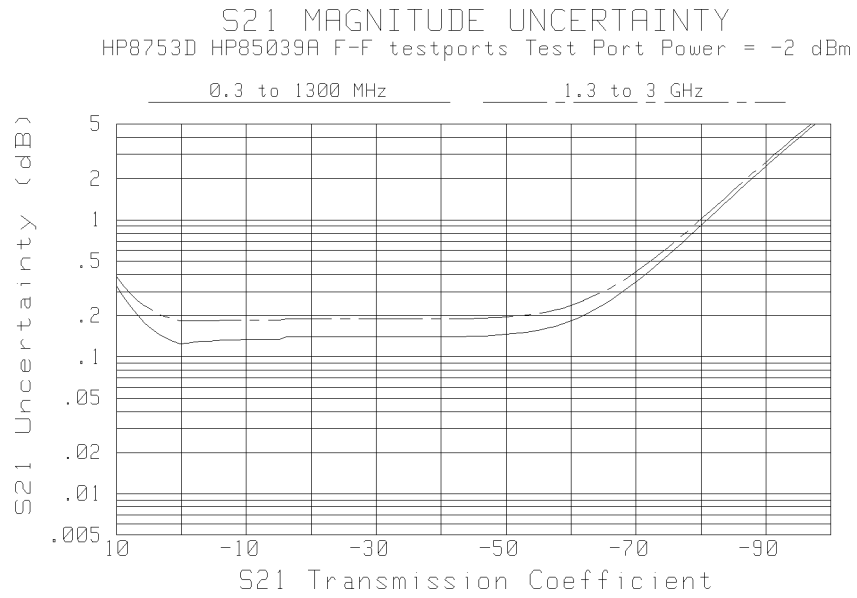

Table 7-9.
Measurement Port Characteristics (Corrected)* for HP 8753D (75Ω)
using HP 85039A F-F Testports

	Frequency Range		
	30 kHz to 300 kHz [†]	300 kHz to 1.3 GHz	1.3 GHz to 3 GHz
Directivity	38 dB	38 dB	32 dB
Source match	36 dB	36 dB	30 dB
Load match	32 dB	32 dB	26 dB
Reflection tracking	±0.0080 dB	±0.0080 dB	±0.0320 dB
Transmission tracking	±0.0959 dB	±0.0518 dB	±0.1118 dB
* Applies at 25 ± 5 °C			
† Typical Performance			

Transmission Measurement Uncertainties



Reflection Measurement Uncertainties

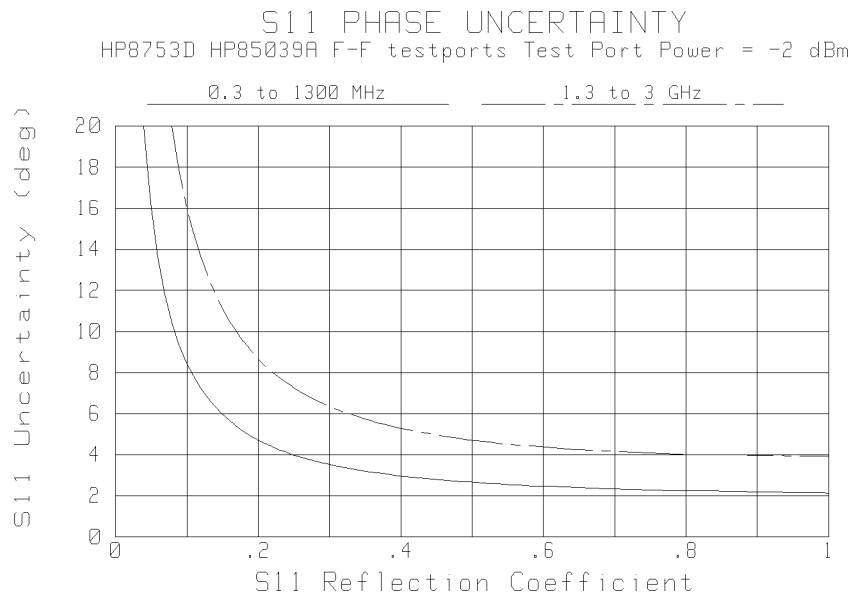
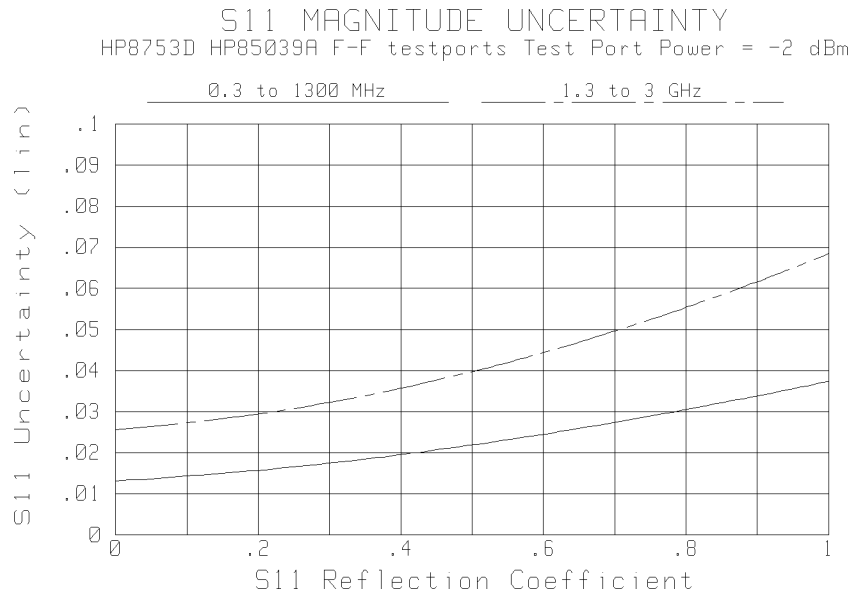
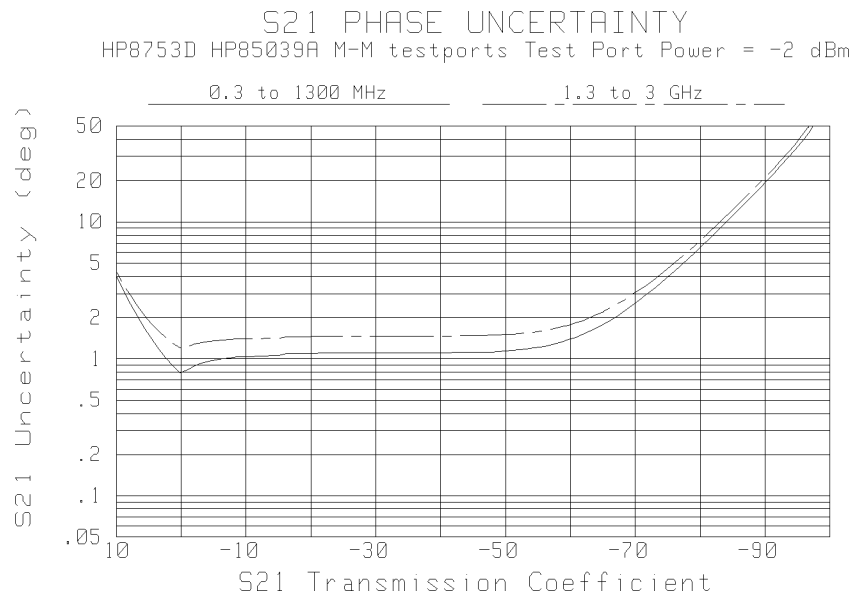
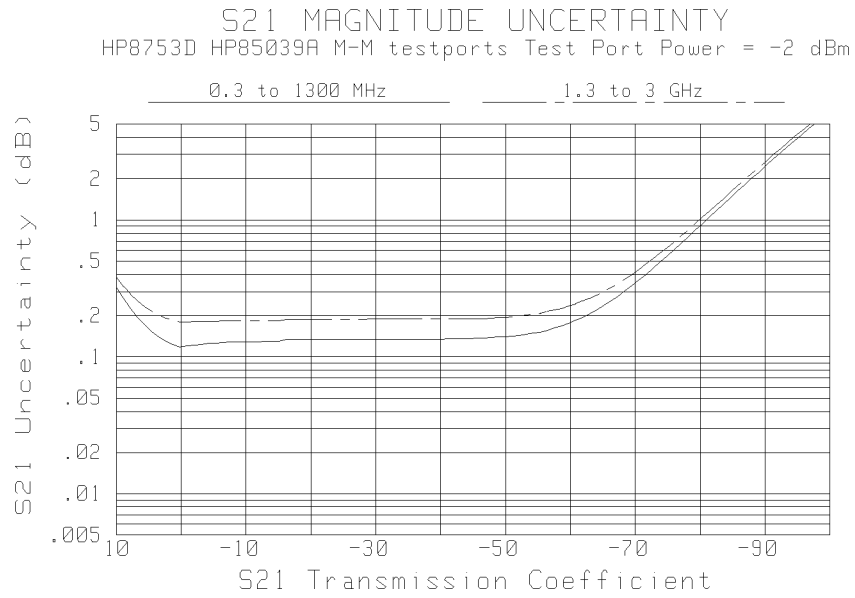

Table 7-10.
Measurement Port Characteristics (Corrected)* for HP 8753D (75Ω)
using HP 85039A M-M Testports

	Frequency Range		
	30 kHz to 300 kHz [†]	300 kHz to 1.3 GHz	1.3 GHz to 3 GHz
Directivity	32 dB	32 dB	26 dB
Source match	31.950 dB	31.170 dB	25.080 dB
Load match	38 dB	38 dB	32 dB
Reflection tracking	±0.0348 dB	±0.0253 dB	±0.0728 dB
Transmission tracking	±0.0780 dB	±0.0474 dB	±0.1106 dB
* Applies at 25 ±5 °C			
† Typical Performance			

Transmission Measurement Uncertainties



Reflection Measurement Uncertainties

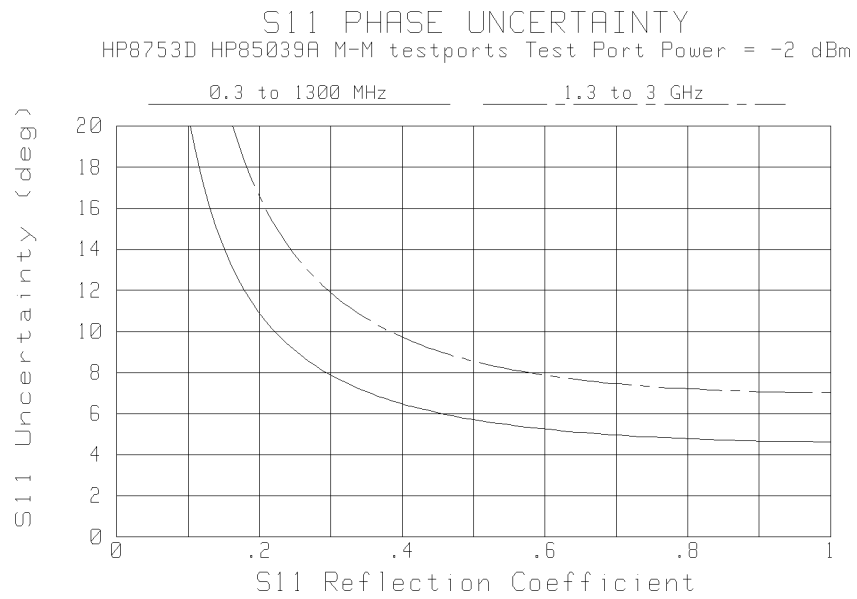
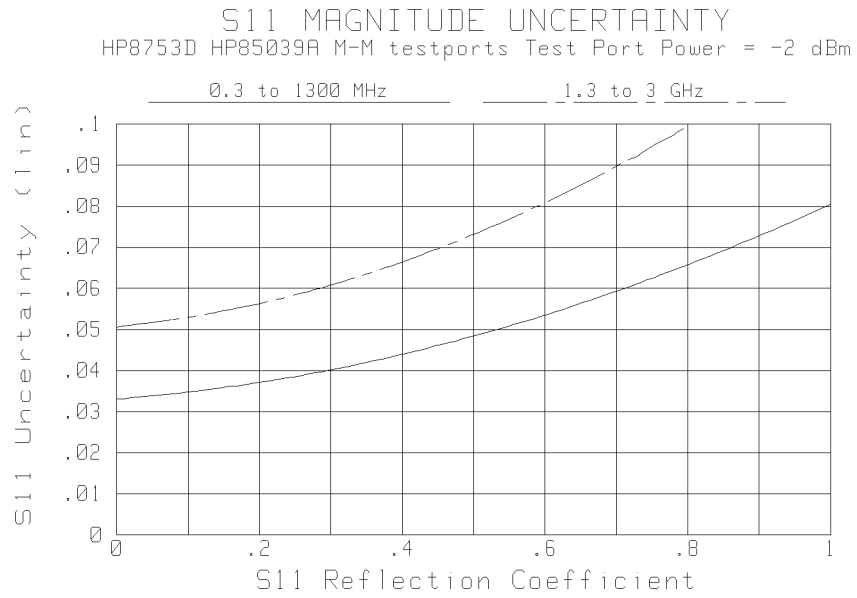
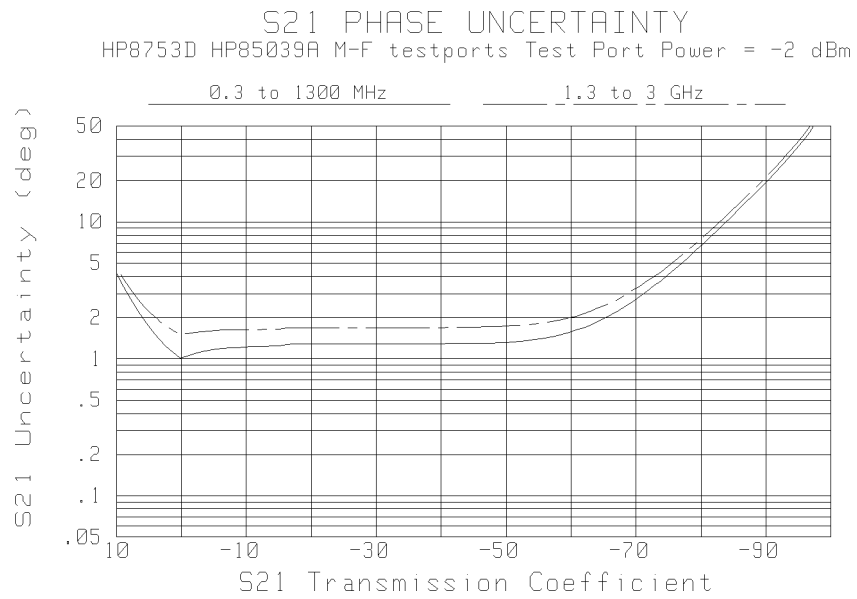
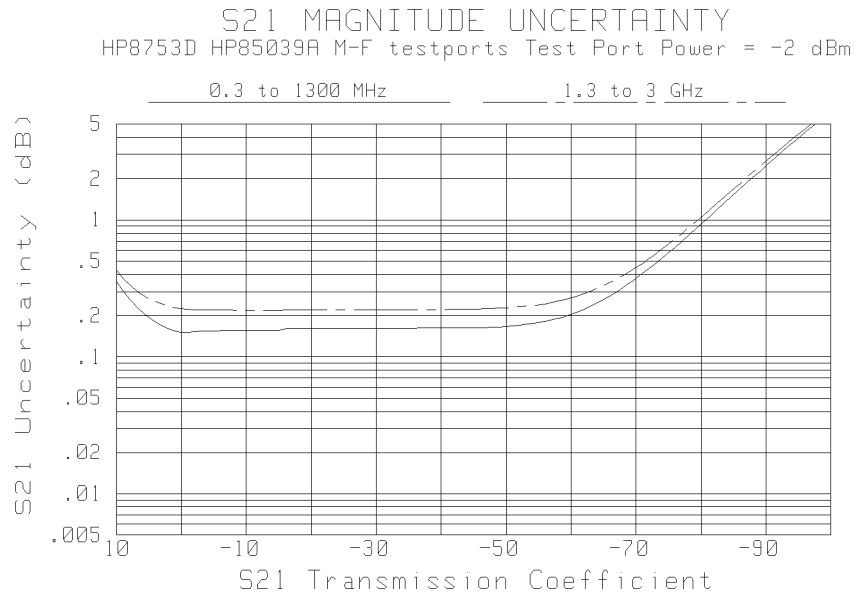

Table 7-11.
Measurement Port Characteristics (Corrected)* for HP 8753D (75Ω)
using HP 85039A M-F Testports

	Frequency Range		
	30 kHz to 300 kHz [†]	300 kHz to 1.3 GHz	1.3 GHz to 3 GHz
Directivity	32 dB	32 dB	26 dB
Source match	31.950 dB	31.170 dB	25.080 dB
Load match	32 dB	32 dB	26 dB
Reflection tracking	± 0.0348 dB	± 0.0253 dB	± 0.0728 dB
Transmission tracking	± 0.1121 dB	± 0.0646 dB	± 0.1445 dB
* Applies at 25 ± 5 °C			
† Typical Performance			

Transmission Measurement Uncertainties



Reflection Measurement Uncertainties

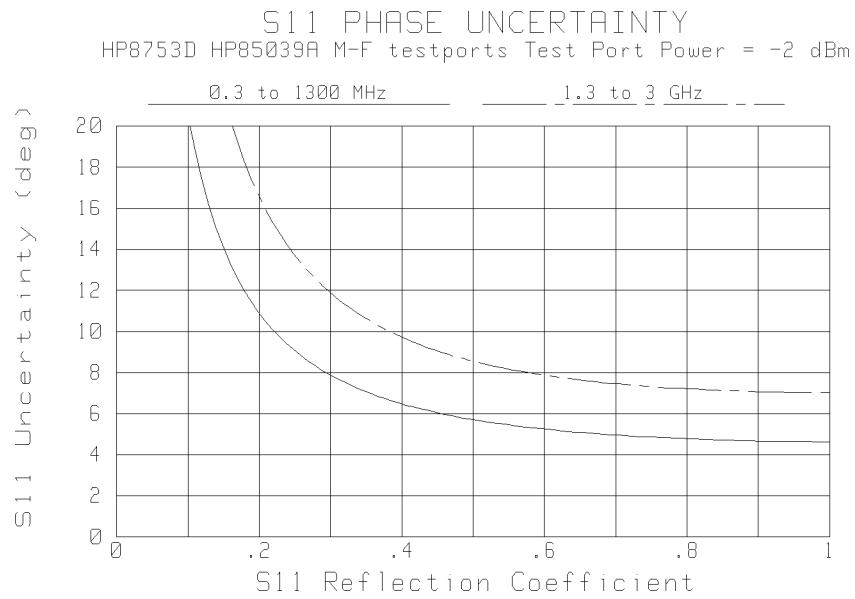
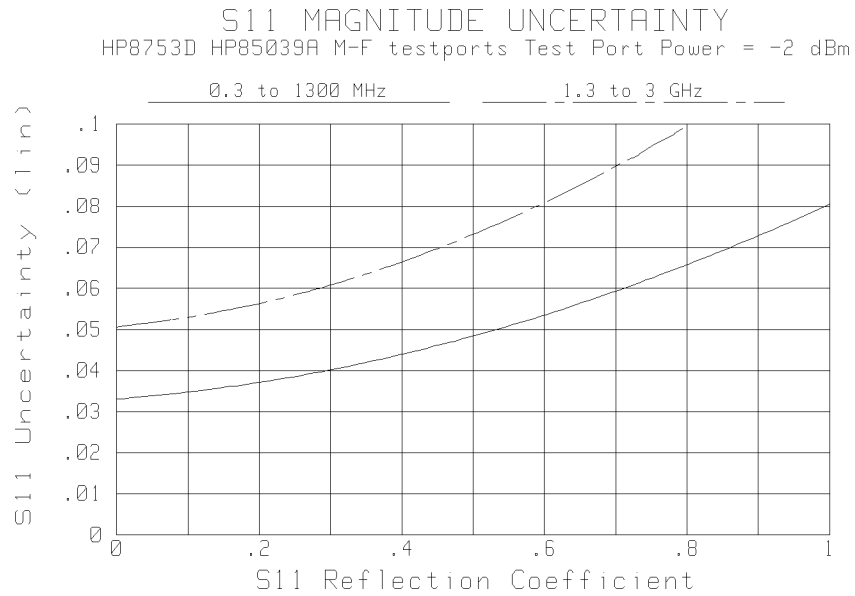

Instrument Specifications

The specifications listed in Table 1 range from those guaranteed by Hewlett-Packard to those typical of most HP 8753D instruments, but not guaranteed. Codes in the far right column of Table 1 reference a specification definition, listed below. These definitions are intended to clarify the extent to which Hewlett-Packard supports the specified performance of the HP 8753D.

S-1: This performance parameter is verifiable using performance tests documented in the service manual.

S-2: Due to limitations on available industry standards, the guaranteed performance of the instrument cannot be verified outside the factory. Field procedures can verify performance with a confidence prescribed by available standards.

S-3: These specifications are generally digital functions or are mathematically derived from tested specifications, and can therefore be verified by functional pass/fail testing.

T: Typical but non-warranted performance characteristics intended to provide information useful in applying the instrument. Typical characteristics are representative of most instruments, though not necessarily tested in each unit. Not field tested.

Table 7-12. HP 8753D Instrument Specifications (1 of 6)

TEST PORT OUTPUT			
Description	Specification	Code	
FREQUENCY CHARACTERISTICS			
Range			
Standard	30 kHz to 3 GHz		S-1
Option 006	30 kHz to 6 GHz		S-1
Accuracy (at 25 °C ±5 °C)	±10 ppm		S-1
Stability			
0 ° to 55 °C	±7.5 ppm		T
per year	±3 ppm		T
Resolution	1 Hz		S-3
OUTPUT POWER CHARACTERISTICS			
Range:			
Standard	-85 to +10 dBm		S-1
Option 075	-85 to +8 dBm		S-1
Resolution	0.05 dB		S-3
Level Accuracy (at 0 dBm output level) (at 25 °C ± 5 °C)†	±1.0 dB		S-1*
Linearity (at 25 °C ±5 °C)†			
-15 to +5 dBm	±0.2 dB (relative to 0 dBm output level)		S-1
+5 to +10 dBm (Standard)	±0.5 dB (relative to 0 dBm output level)		S-1
+5 to +8 dBm (Option 075)	±0.5 dB (relative to 0 dBm output level)		S-1
Impedance			
Standard	50 ohms: >16 dB return loss to 3 GHz >14 dB return loss to 6 GHz		T T
Impedance			
Option 075	75 ohms: >10 dB return loss to 300 kHz >16 dB return loss to 3 GHz		T T
SPECTRAL PURITY CHARACTERISTICS			
2nd Harmonic (16 MHz to 3 GHz)			
at +10 dBm output level	< -25 dBc		S-1*
at 0 dBm output level	< -40 dBc		T
at -10 dBm output level	< -50 dBc		T
3rd Harmonic (16 MHz to 2 GHz)			
at +10 dBm output level	< -25 dBc		S-1*
at 0 dBm output level	< -40 dBc		T
at -10 dBm output level	< -50 dBc		T
Non-Harmonic Spurious Signals			
Mixer Related			
at +10 dBm output level	< -30 dBc		T
at -10 dBm output level	< -55 dBc		T

* Explicitly tested as part of an on-site verification performed by Hewlett-Packard.

† Typical 30 kHz to 300 kHz and typical from 2 to 3 GHz for Option 075.

Table 7-12. HP 8753D Instrument Specifications (2 of 6)

TEST PORT INPUTS			
Description	Specification	Code	
CHARACTERISTICS			
Frequency Range			
Standard	30 kHz to 3 GHz	S-1	
Option 006	30 kHz to 6 GHz	S-1	
Impedance	50 ohms nominal (Standard)		
Standard:			
30 kHz to 50 kHz	≥ 10 dB return loss	T	
50 kHz to 300 kHz	≥ 18 dB return loss	T	
300 kHz to 1.3 GHz	≥ 18 dB return loss	S-1	
1.3 GHz to 3 GHz	≥ 16 dB return loss	S-1	
3 GHz to 6 GHz	≥ 14 dB return loss	S-1	
Impedance	75 ohms nominal (Option 075)		
Option 075:			
30 kHz to 300 kHz	≥ 10 dB return loss	T	
300 kHz to 3 GHz	≥ 16 dB return loss	T	
Maximum Input Level	+ 10 dBm	S-1	
Damage Level	+26 dBm or > 35 Vdc	T	
Average Noise Level			
300 kHz to 3 GHz			
3 kHz IF bandwidth	-82 dBm	S-1*	
10 Hz IF bandwidth	-102 dBm	S-1*	
	-110 dBm	T	
3 GHz to 6 GHz			
3 kHz IF bandwidth	-77 dBm	S-1*	
10 Hz IF bandwidth	-97 dBm	S-1*	
	-105 dBm	T	
Frequency Response (25 ±5 °C)			
300 kHz to 3 GHz	±1 dB	S-1*	
3 GHz to 6 GHz	±2 dB	S-1*	
Internally Generated Harmonics (option 002)			
2nd Harmonic			
at +8 dBm input level	< -15 dBc	S-1*	
at +0 dBm input level	< -30 dBc	T	
at -15 dBm input level	< -45 dBc	T	
3rd Harmonic			
at +8 dBm input level	< -30 dBc	S-1*	
at +0 dBm input level	< -50 dBc	T	
at -15 dBm input level	< -50 dBc	T	
Harmonic Measurement Accuracy (25 ±5 °C)			
16 MHz to 3 GHz	±1 dB	S-1	
3 GHz to 6 GHz†	±3 dB	S-1	
Harmonic Measurement Dynamic Range (with output at -10 dBm and input at < -15 dBm)	-40 dBc	T	
* Explicitly tested as part of an on-site verification performed by Hewlett-Packard.			
† Operation from 3 GHz to 6 GHz requires Option 006.			

Table 7-12. HP 8753D Instrument Specifications (3 of 6)

R CHANNEL INPUT			
Description	Specification	Code	
Frequency Offset Operation*†			
Frequency Range‡	300 kHz to 6 GHz	S-1	
R Channel Input Requirements (required for phase-locked operation)	0 to -35 dBm, to 3 GHz 0 to -30 dBm, 3 GHz to 6 GHz 0 to -30 dBm, 3 GHz to 6 GHz	S-1 S-1 S-1	
LO Spectral Purity and Accuracy			
Maximum Spurious Input	< -25 dBc	T	
Residual FM	< 20 kHz	T	
Frequency Accuracy	-1 to +1 MHz of nominal frequency	T	
Accuracy (see <i>Magnitude Characteristics</i> and <i>Phase Characteristics</i>)			
External Source Mode†§ (CW Time sweep only)			
Frequency Range‡	300 kHz to 6 GHz	S-1	
R Input Requirements			
Power Level	0 to -25 dBm	T	
Spectral Purity			
Maximum Spurious Input	< -30 dBc	T	
Residual FM	< 20 kHz	T	
Setting Time			
Auto	500 ms	T	
Manual	50 ms	T	
Frequency Readout Accuracy (auto)	0.1%	T	
Input Frequency Margin			
Manual	-0.5 to 5 MHz	T	
Auto			
≤ 50 MHz	± 5 MHz of nominal CW frequency	T	
> 50 MHz	± 10% of nominal CW frequency	T	
Accuracy (see <i>Magnitude Characteristics</i> and <i>Phase Characteristics</i>)§			
<p>* The HP 8753D RF source characteristics in this mode are dependent on the stability of the external LO source. The RF source tracks the LO to maintain a stable IF signal at the R channel receiver input. Degradation in accuracy is negligible with an HP 8642A/B or HP 8656B RF signal generator as the LO source.</p> <p>† Refer to "HP 8753D Descriptions and Options" for a functional description.</p> <p>‡ Operation from 3 GHz to 6 GHz requires option 006.</p> <p>§ Measurement accuracy is dependent on the stability of the input signal.</p>			

Table 7-12. HP 8753D Instrument Specifications (4 of 6)

INPUT GENERAL		
Description	Specification	Code
MAGNITUDE CHARACTERISTICS		
Display Resolution	0.01 dB/division	S-3
Marker* Resolution	0.001 dB	S-3
Dynamic Accuracy (10 Hz BW, inputs Test Port 1 and Test Port 2; R to -35 dBm) (see graph)		S-1
<p>DYNAMIC ACCURACY HP8753D Reference Power = -20 dBm</p> <p>0.3 to 3000 MHz 3 to 6 GHz</p> <p style="text-align: center;">Accuracy (dB)</p> <p style="text-align: center;">Test Port Power (dBm)</p> <p style="text-align: center;">Dynamic Accuracy (Magnitude)</p>		
Trace Noise†		
30 kHz to 3GHz	<0.006 dB rms	S-1
3 GHz to 6 GHz	<0.010 dB rms	S-1
Reference Level		
Range	±500 dB	S-3
Resolution	0.001 dB	S-3
Stability		
30 kHz to 3 GHz	0.02 dB/°C	T
3 GHz to 6 GHz	0.04 dB/°C	T
PHASE CHARACTERISTICS		
Range	±180 °	S-3
Display Resolution	0.01 °/division	S-3
Marker Resolution*	0.01 °	S-3
* Marker resolution for magnitude, phase, and delay is dependent upon the value measured; resolution is limited to 5 digits.		
† CW sweep, +5 dBm into Test Port, ratio measurement, 3 kHz BW		

Table 7-12. HP 8753D Instrument Specifications (5 of 6)

INPUT GENERAL (cont.)		
Description	Specification	Code
PHASE CHARACTERISTICS (cont.)		
Dynamic Accuracy (10 Hz BW, inputs Test Port 1 and Test Port 2; R to -35 dBm) (see graph)		S-1
<p>DYNAMIC ACCURACY HP8753D Reference Power = -20 dBm</p> <p>0.3 to 3000 MHz 3 to 6 GHz</p> <p style="text-align: center;">Accuracy (deg)</p> <p style="text-align: center;">Test Port Power (dBm)</p> <p style="text-align: center;">Dynamic Accuracy (Phase)</p>		
Trace Noise (+5 dBm into Test Port, ratio measurement)		
30 kHz to 3 GHz	<0.038 °rms	S-1
3 GHz to 6 GHz	<0.070 °rms	S-1
Reference Level		
Range	±500 °	S-3
Resolution	0.01 °	S-3
Stability		
30 kHz to 3 GHz	0.05 °/degree C	T
3 GHz to 6 GHz	0.20 °/degree C	T
POLAR CHARACTERISTICS (ratio measurement)		
Range	10×10^{-12} up to 1000 units full scale	S-3
Reference	range of ±500 units	S-3

Table 7-12. HP 8753D Instrument Specifications (6 of 6)

INPUT GENERAL (cont.)			
Description	Specification	Code	
GROUP DELAY CHARACTERISTICS			
Group delay is computed by measuring the phase change within a specified frequency step (determined by the frequency span and the number of points per sweep).			
Aperture (selectable)	(frequency span)/(number of points - 1)	S-3	
Maximum Aperture	20% of frequency span	S-3	
Range	1/2 x (1/minimum aperture)	S-3	
(The maximum delay is limited to measuring no more than 180 ° of phase change within the minimum aperture.)			
Accuracy	(see graph)	S-3	
The following graph shows group delay accuracy with an HP 85047A Test Set with 7 mm full 2-port calibration and a 10 Hz IF bandwidth. Insertion loss is assumed to be <2 dB and electrical length to be ten meters.			
<p>Group Delay Accuracy</p> <p>HP8753D/HP85031B at -10 dBm Electrical Length = 10 meters</p> <p>0.3 to 1300 MHz 1.3 to 3 GHz 3 to 6 GHz</p> <p>Group Delay Accuracy vs. Aperture</p>			
In general, the following formula can be used to determine the accuracy, in seconds, of specific group delay measurement:			
$\pm[0.003 \times \text{Phase Accuracy (deg)}/\text{Aperture (Hz)}$			
Depending on the aperture and device length, the phase accuracy used is either incremental phase accuracy or worst case phase accuracy.			
frequency span and the number of points per sweep).			
Aperture (selectable)	(frequency span)/(number of points - 1)	S-3	
Maximum Aperture	20% of frequency span	S-3	
Range	1/2 x (1/minimum aperture)	S-3	
(The maximum delay is limited to measuring no more than 180 ° of phase change within the minimum aperture.)			
Accuracy	(see graph)	S-3	

HP 8753D Network Analyzer General Characteristics

Measurement Throughput Summary

The following table shows typical measurement times for the HP 8753D network analyzer in milliseconds.

Table 7-13. Typical Measurement Times

Typical Time for Completion (ms)				
	Number of Points			
	51	201	401	1601
Measurement				
Uncorrected	125	200	300	900
1-port cal*	125	200	300	900
2-port cal†	245	510	855	2940
Time Domain Conversion‡	80	350	740	1790
HP-IB Data Transfer§				
Binary (Internal)	20	35	55	205
IEEE754 floating point format				
32 bit	25	85	150	590
64 bit	40	115	220	840
ASCII	140	510	1000	3960
* S11 1-port calibration, with a 3 kHz IF bandwidth. Includes system retrace time, but does not include bandswitch time. Time domain gating is assumed off. † S21 measurement with full 2-port calibration, using a 3 kHz IF bandwidth. Includes system retrace time and RF switching time, but does not include bandswitch time. Time domain gating is assumed off. ‡ Option 010 only, gating off. § Measured with HP 9000 series 300 computer.				

Remote Programming

Interface

HP-IB interface operates according to IEEE 488-1978 and IEC 625 standards and IEEE 728-1982 recommended practices.

Transfer Formats

Binary (internal 48-bit floating point complex format)

ASCII

32/64 bit IEEE 754 Floating Point Format

Interface Function Codes

SH1, AH1, T6, TE0, L4, LE0, SR1, RL1, PP0, DC1, DT1, C1, C2, C3, C10, E2

Front Panel Connectors

Connector Type.....	7 mm precision
Impedance.....	50 ohms (nominal)
Connector Conductor Depth.....	0.000 to 0.003 in.

Probe Power

- +15 V \pm 2% 400 mA (combined load for both probe connections)
 - 12.6 V \pm 5.5% 300 mA (combined load for both probe connections)
-

Rear Panel Connectors**External Reference Frequency Input (EXT REF INPUT)**

Frequency.....	1, 2, 5, and 10 MHz (\pm 200 Hz at 10 MHz)
Level.....	-10 dBm to +20 dBm, typical
Impedance.....	50 ohms

High-Stability Frequency Reference Output (10 MHz)(Option 001)

Frequency.....	10.0000 MHz
Frequency Stability (0 °C to 55 °C).....	\pm 0.05 ppm
Daily Aging Rate (after 30 days).....	$\leq 3 \times 10^{-9}$ /day
Yearly Aging Rate.....	0.5 ppm/year
Output.....	0 dBm minimum
Nominal Output Impedance.....	50 Ω

External Auxiliary Input (AUX INPUT)

Input Voltage Limits.....	-10 V to +10 V
---------------------------	----------------

External AM Input (EXT AM)

\pm 1 volt into a 5 k Ω resistor, 1 kHz maximum, resulting in approximately 8 dB/volt amplitude modulation.

External Trigger (EXT TRIGGER)

Triggers on a negative TTL transition or contact closure to ground.

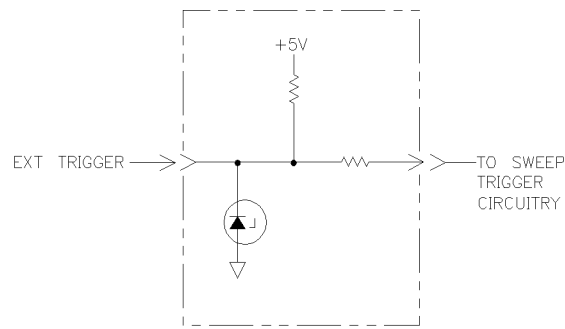

pg6145d

Figure 7-1. External Trigger Circuit

Test Sequence Output (TEST SEQ)

This connector outputs a TTL signal which can be programmed by the user in a test sequence to be high or low. By default, this output provides an end-of-sweep TTL signal. (For use with part handlers.)

Limit Test Output (LIMIT TEST)

This connector outputs a TTL signal of the limit test results. Pass: TTL high; Fail: TTL low.

Test Port Bias Input (BIAS CONNECT)

Maximum voltage	+30 Vdc
Maximum current (no degradation in RF specifications)	± 200 mA
Maximum current	± 1 A

Video Output (EXT MON)

The R, G, and B connectors drive external monitors with these characteristics:

- R, G, B with synch on green.
- 75 ohm impedance.
- 1 Vp-p (0.7 V= white; 0 V= black; -0.3 V= synch).

HP-IB

This connector allows communication with compatible devices including external controllers, printers, plotters, disk drives, and power meters.

Parallel Port

This connector is used with parallel (or Centronics interface) peripherals such as printers and plotters. It can also be used as a general purpose I/O port, with control provided by test sequencing functions.

RS-232

This connector is used with serial peripherals such as printers and plotters.

DIN Keyboard

This connector is used for the optional AT compatible keyboard for titles and remote front-panel operation.

Line Power

48 to 66 Hz

115 V nominal (90 V to 132 V) or 230 V nominal (198 V to 264 V). 280 VA max.

Environmental Characteristics

General Conditions

RFI and EMI susceptibility: defined by VADE 0730, CISPR Publication 11, and FCC Class B Standards.

ESD (electrostatic discharge): must be eliminated by use of static-safe work procedures and an anti-static bench mat (such as HP 92175T).

Dust: the environment should be as dust-free as possible.

Operating Conditions

Operating Temperature 0 ° to 55 °C

Error-Corrected Temperature Range ± 1 °C of calibration temperature

Humidity 5% to 95% at 40 °C (non-condensing)

Altitude 0 to 4500 meters (15,000 feet)

Non-Operating Storage Conditions

Temperature -40 °C to +70 °C

Humidity 0 to 90% relative at +65 °C (non-condensing)

Altitude 0 to 15,240 meters (50,000 feet)

Weight

Net.....	34 kg (75 lb)
Shipping.....	37 kg (82 lb)

Cabinet Dimensions

222 mm H × 425 mm W × 508 mm D
(8.75 × 16.75 × 20.0 in)
(These dimensions exclude front and rear panel protrusions.)

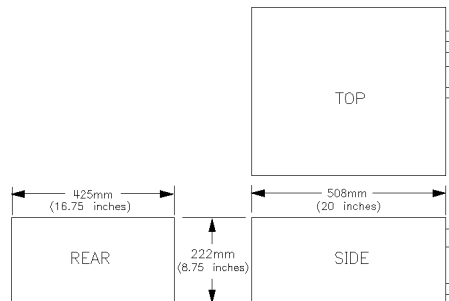

pg6144d

Physical Dimensions

Internal Memory

Data Retention Time with 3 V, 1.2 Ah Battery

Temperature at 70 °C	250 days (0.68 year) characteristically
Temperature at 40 °C	1244 days (3.4 years) characteristically
Temperature at 25 °C	10 years characteristically

Menu Maps

This chapter contains menu maps arranged in the following order:

- (AVG)
- (CAL)
- (COPY)
- (DISPLAY)
- (FORMAT)
- (LOCAL)
- (MARKER)
- (MARKER FCTN)
- (MEAS)
- (MENU)
- (SAVE/RECALL)
- (PRESET)
- (SCALE REF)
- (SEQ)
- (SYSTEM)

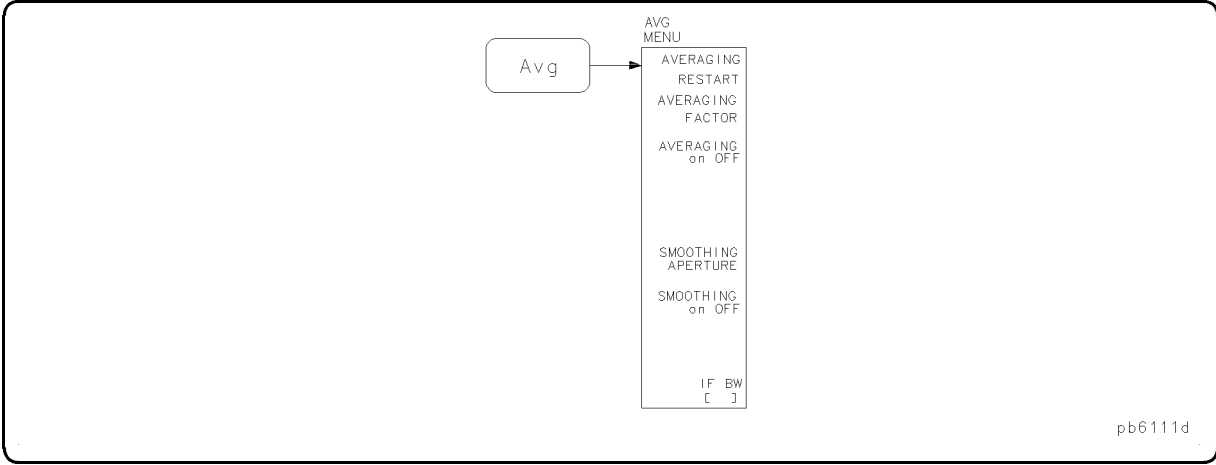

pb6111d

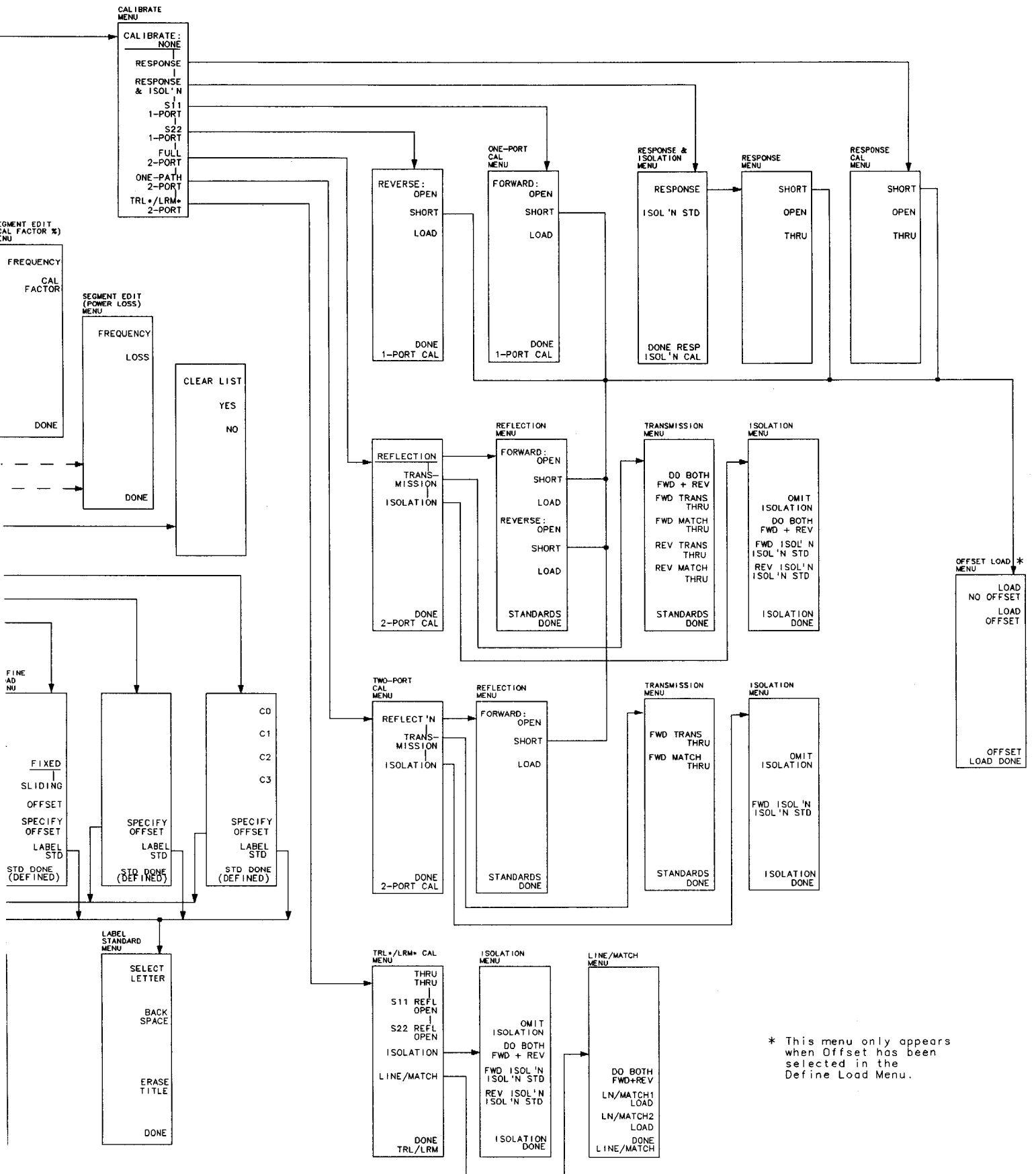

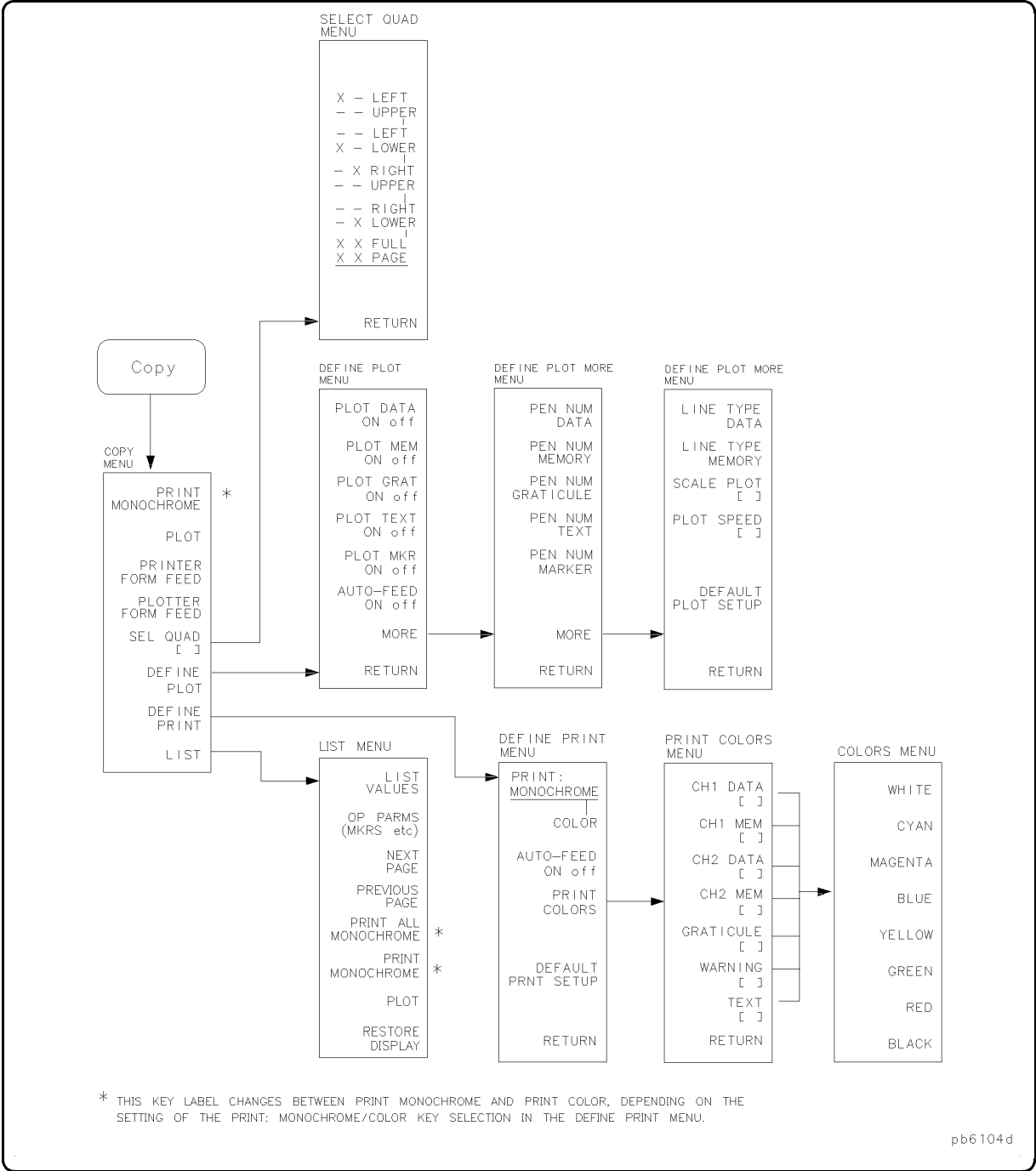

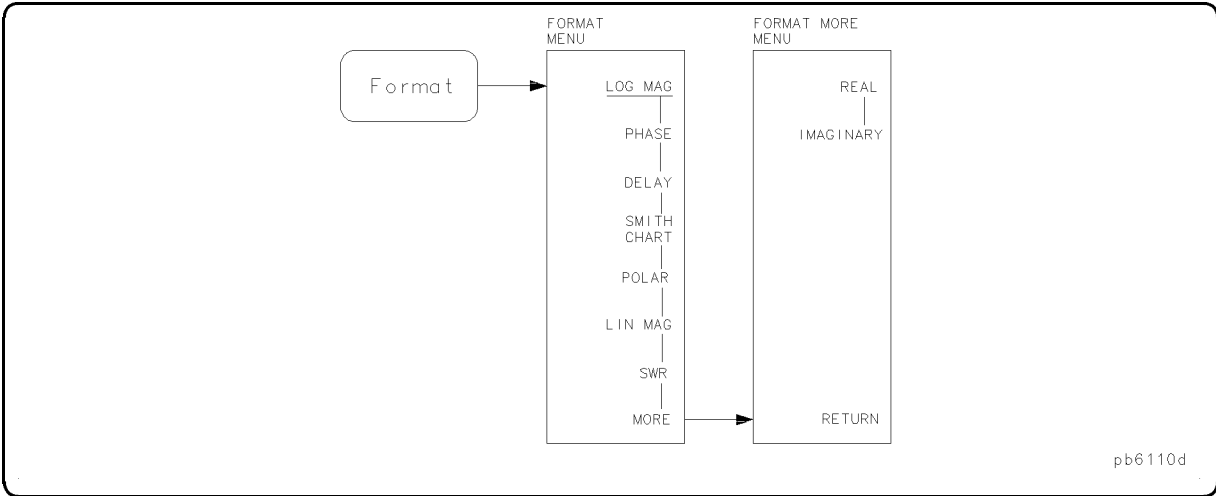
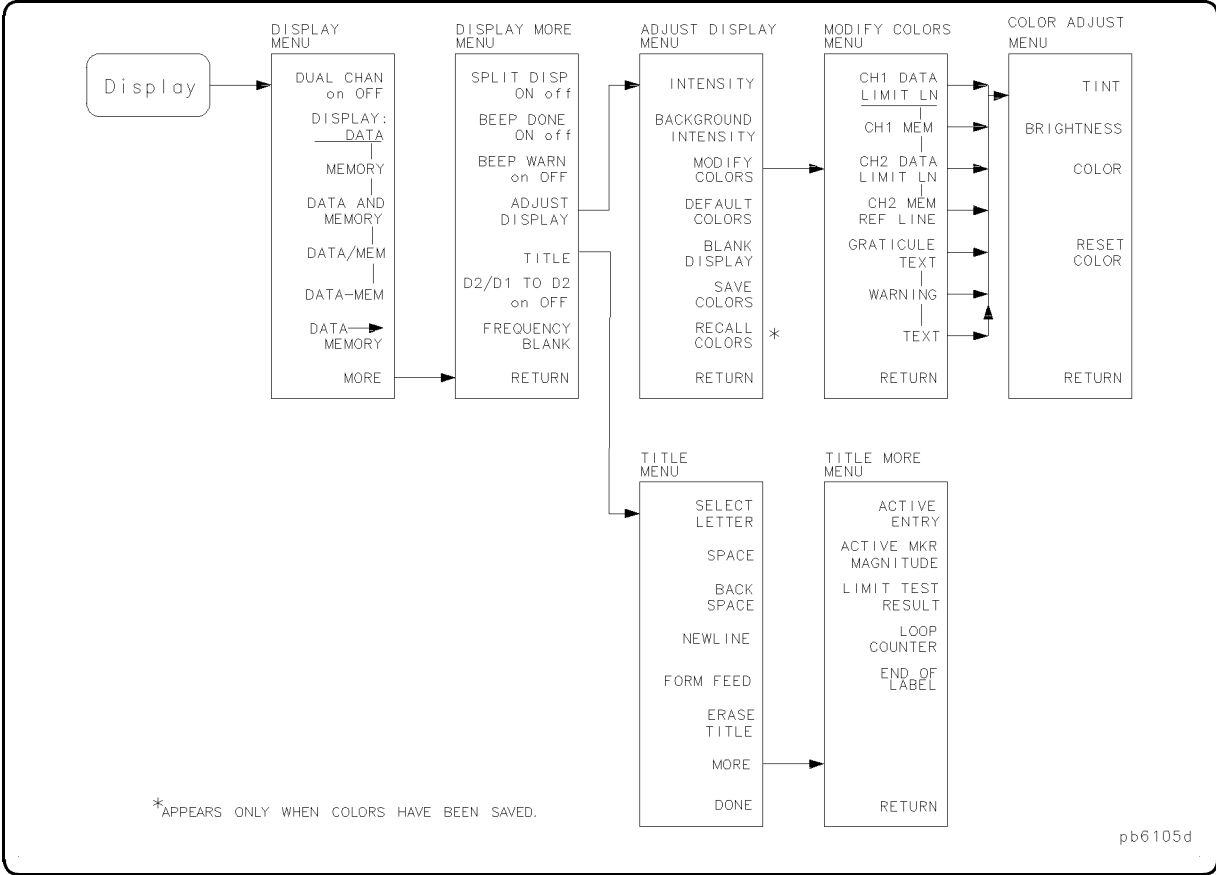

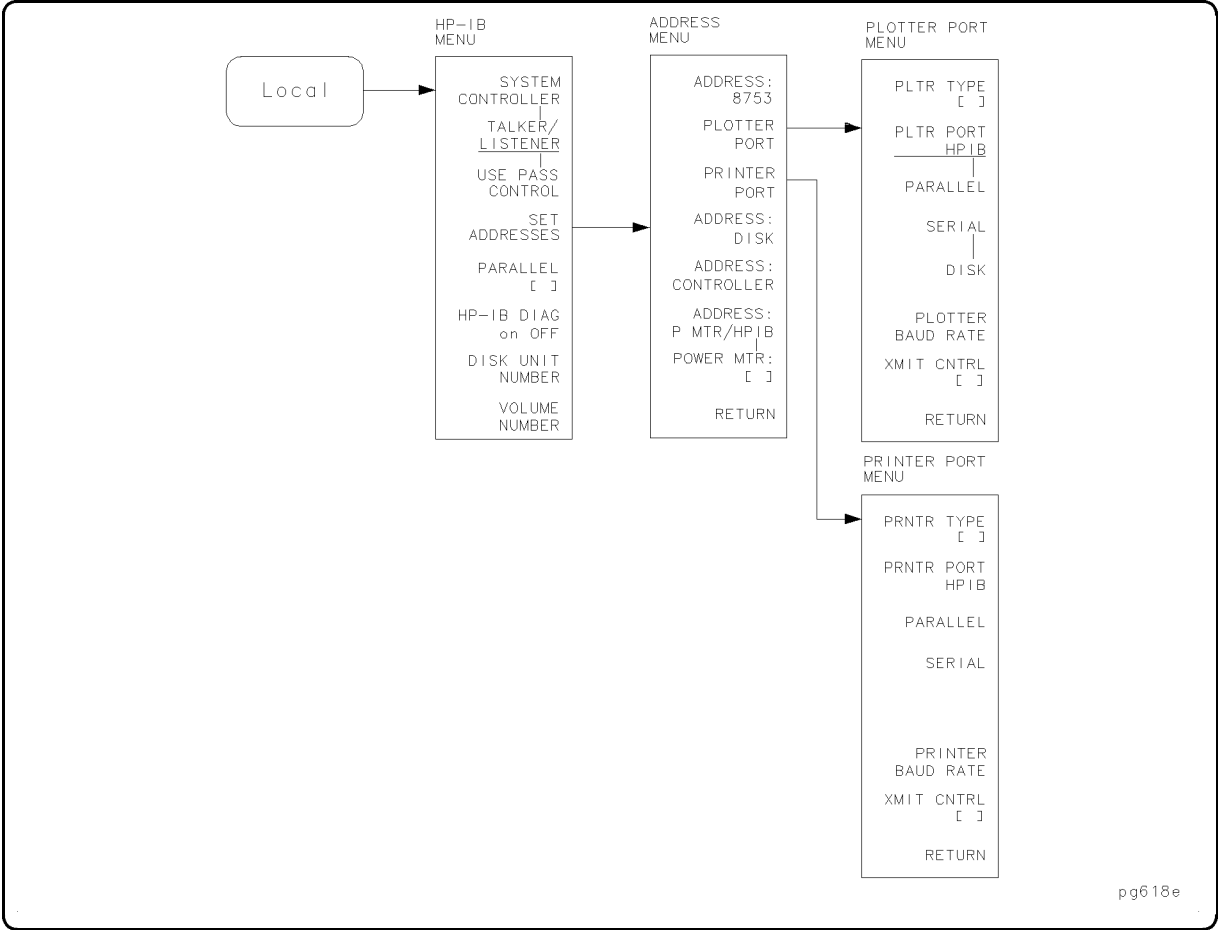

pg618e

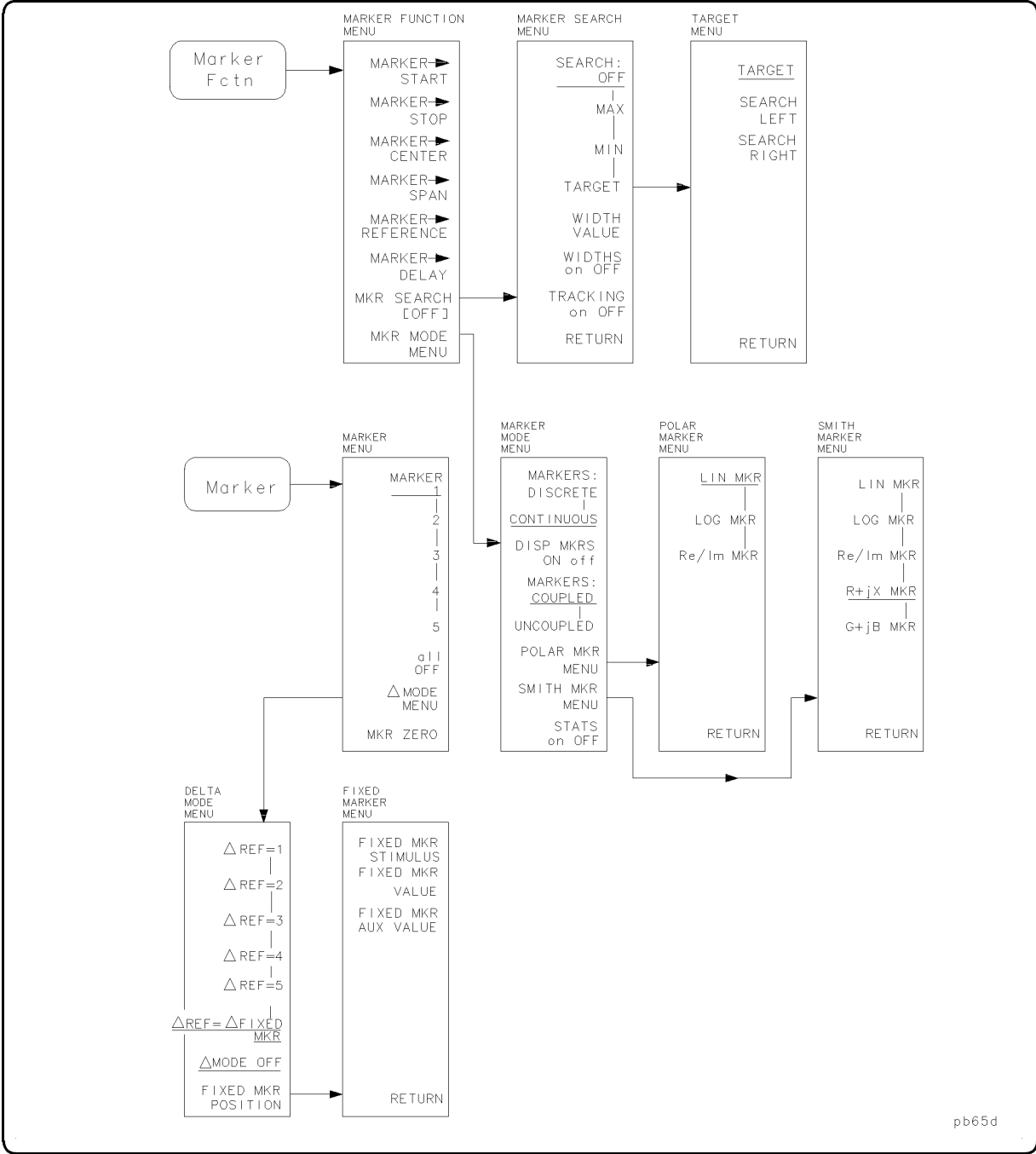

pb65d

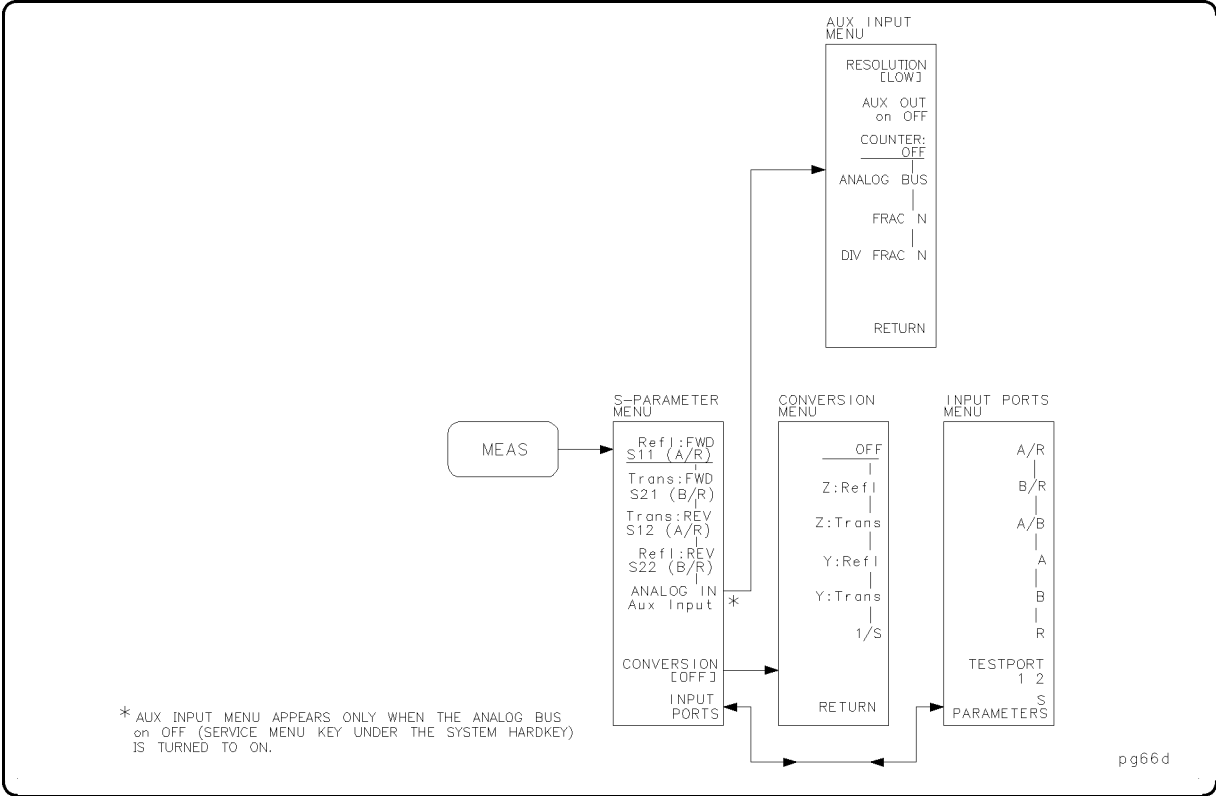

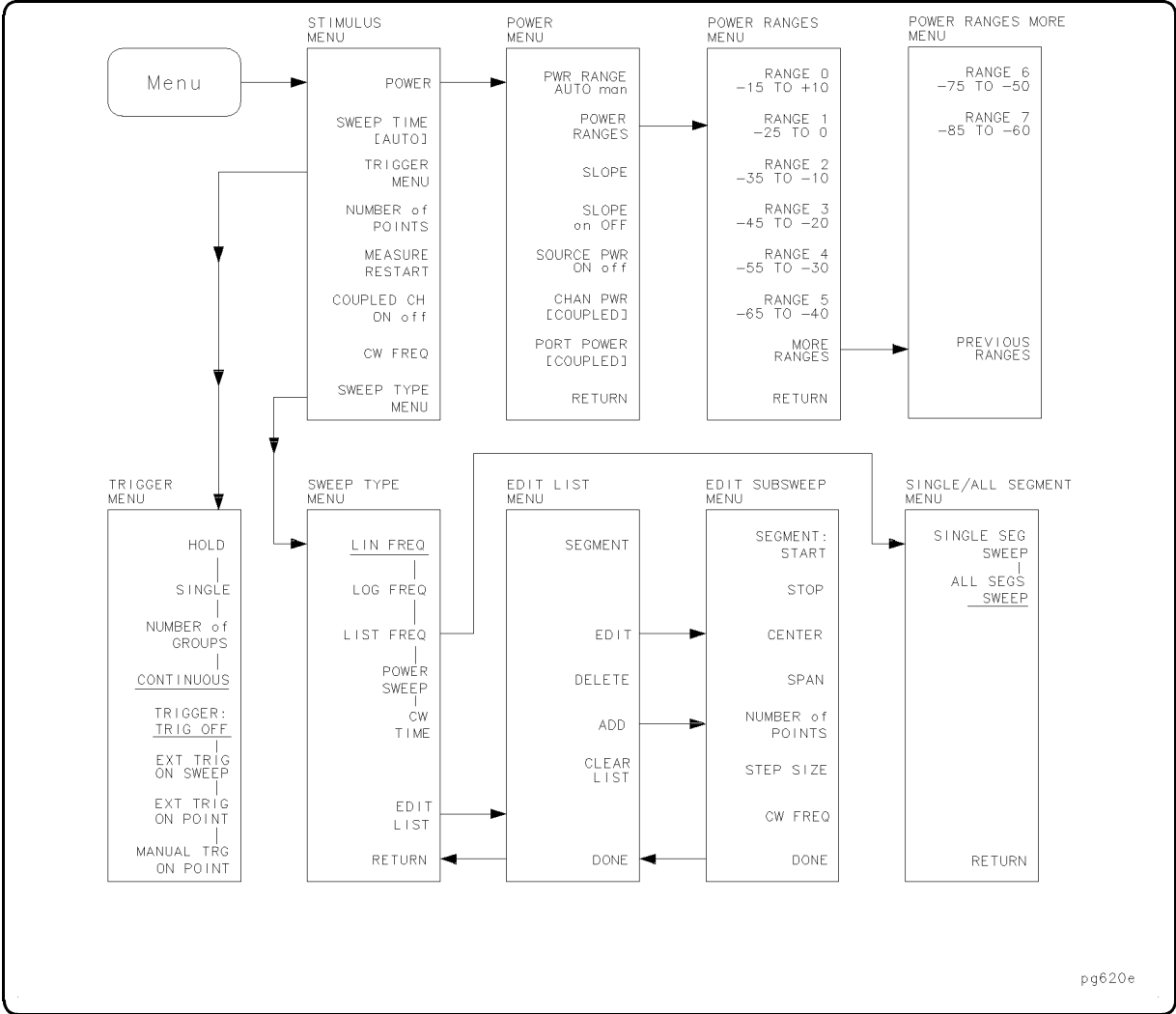

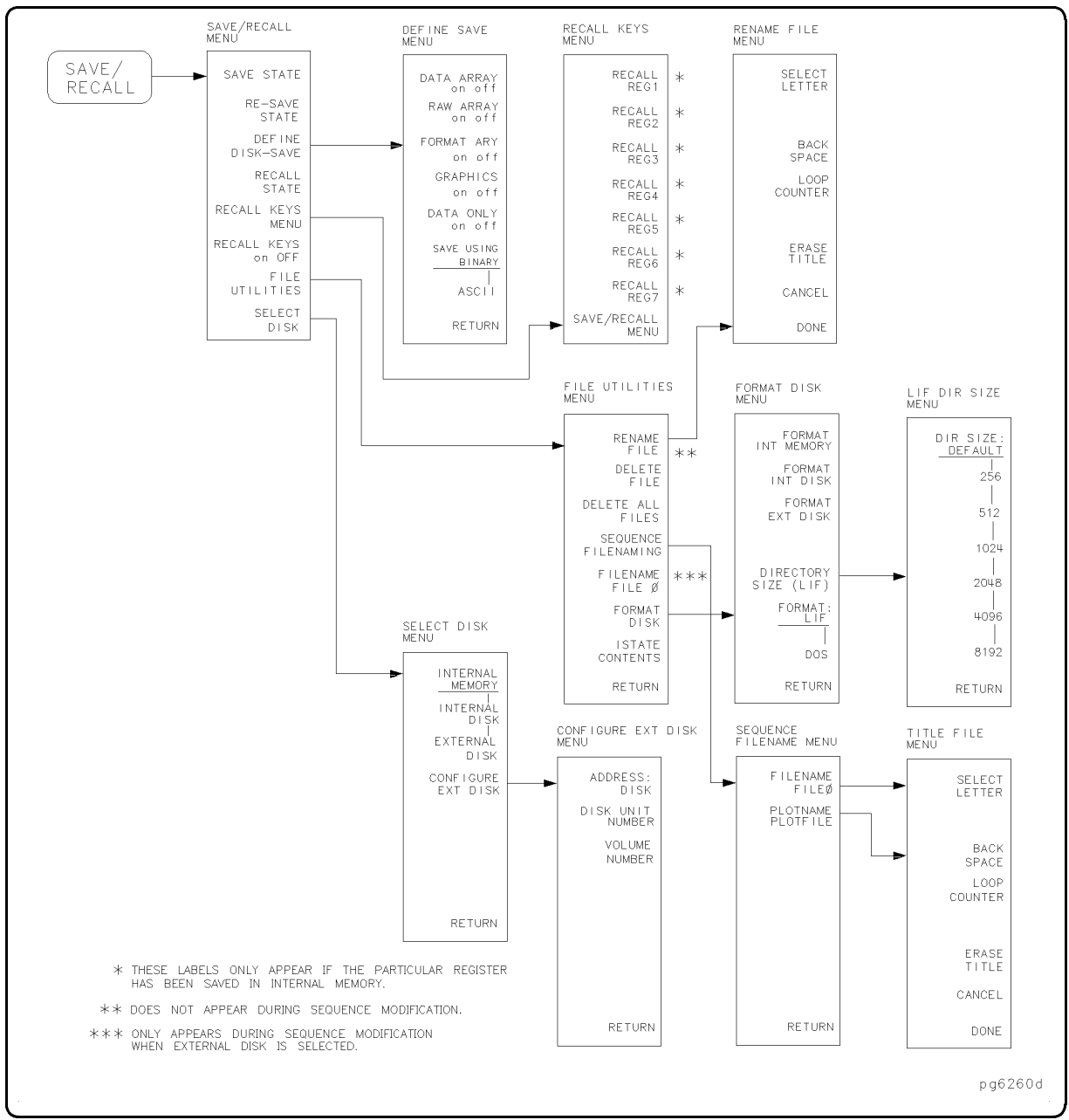

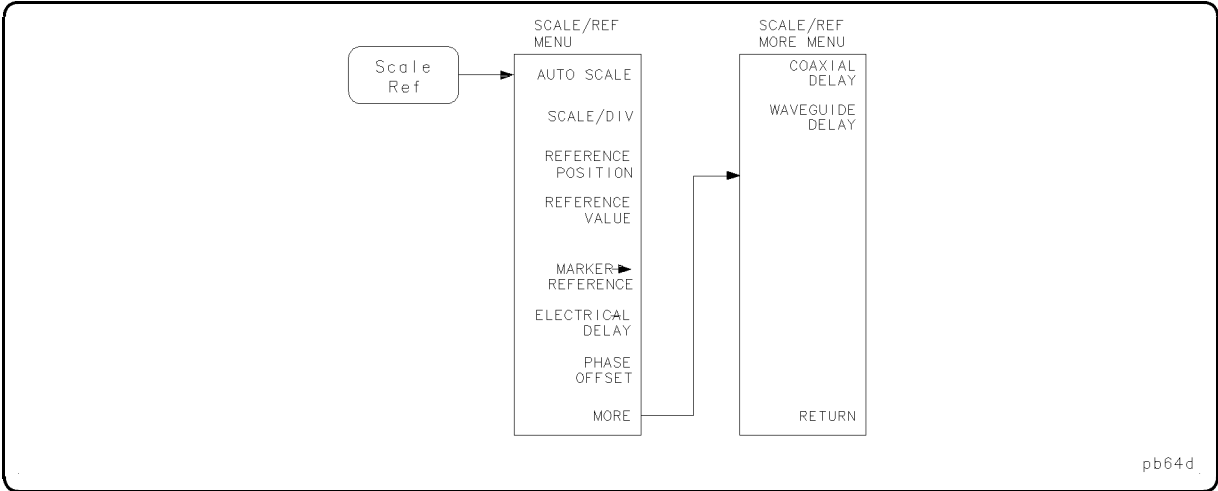
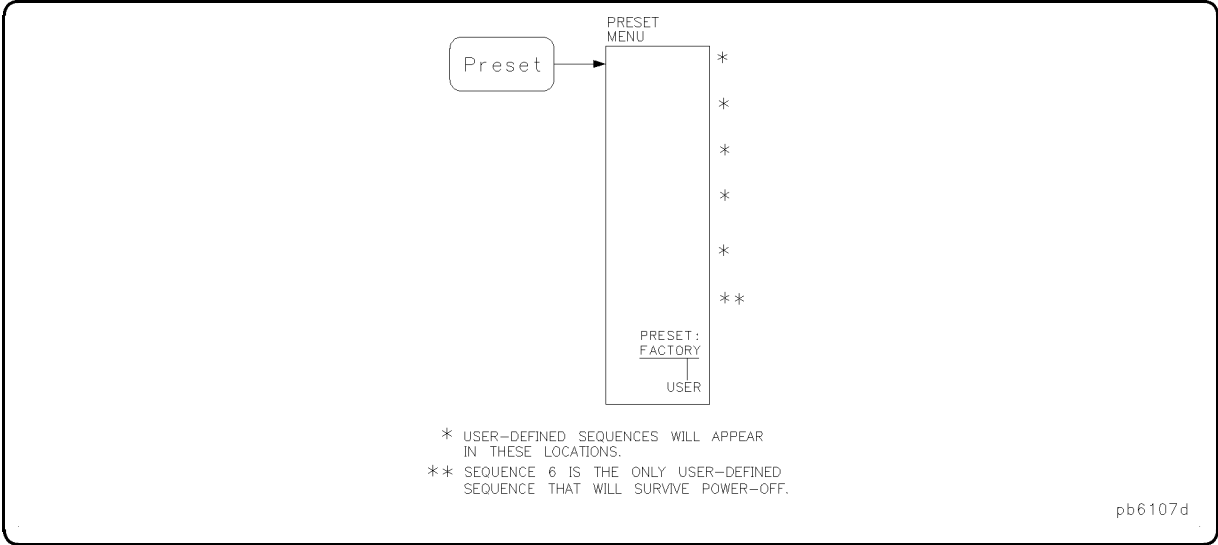

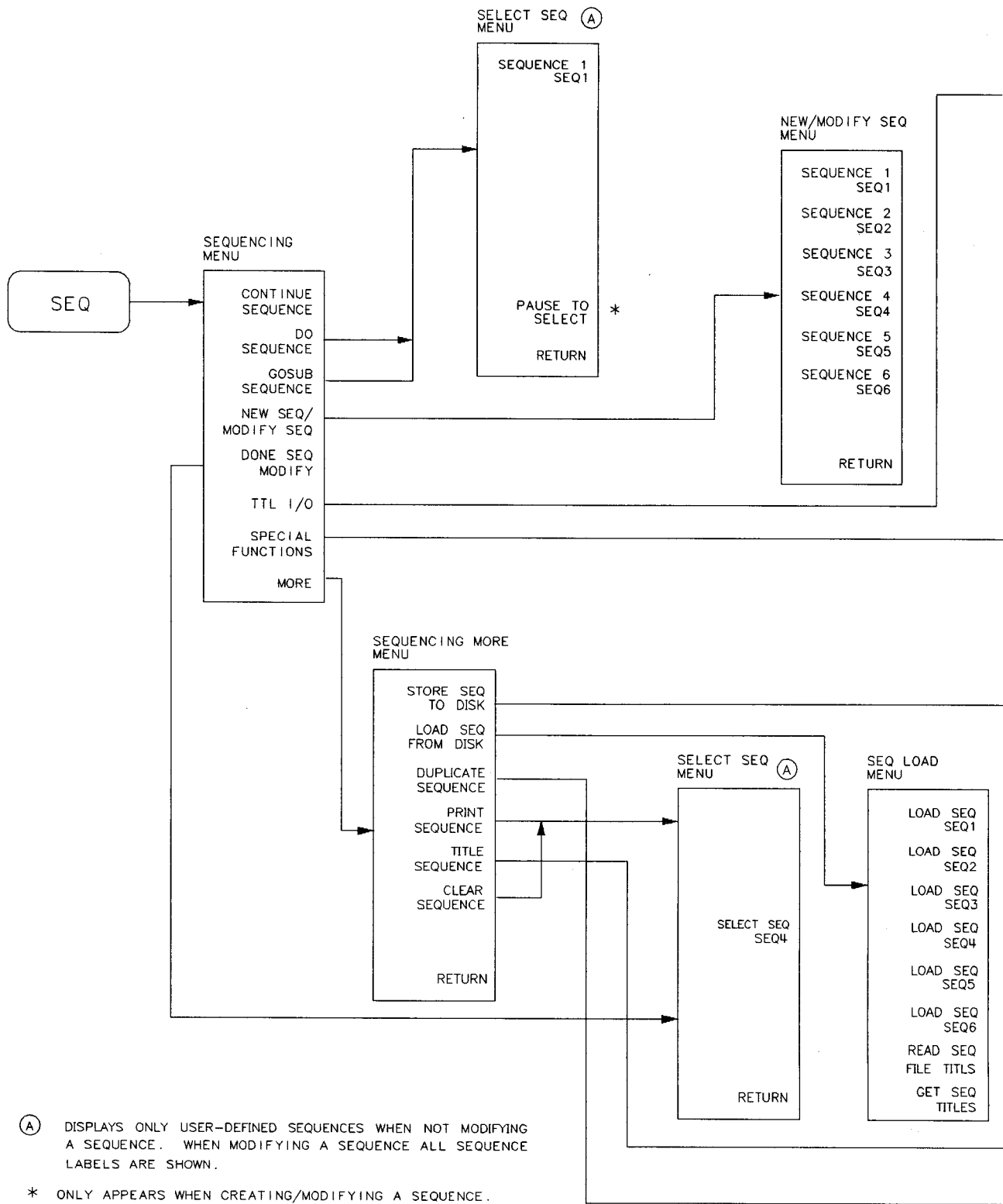

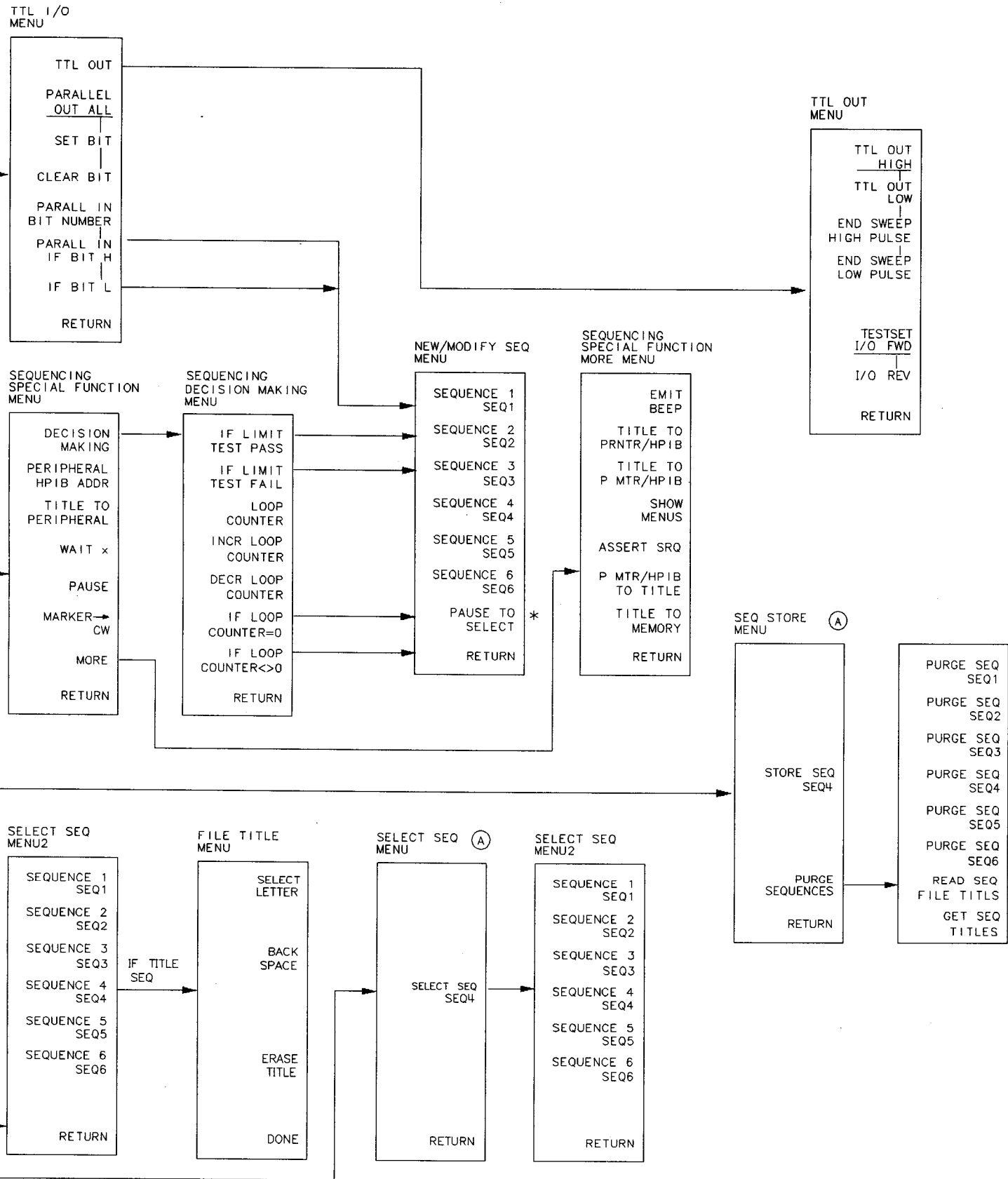

SEQUENCE MENU MAP

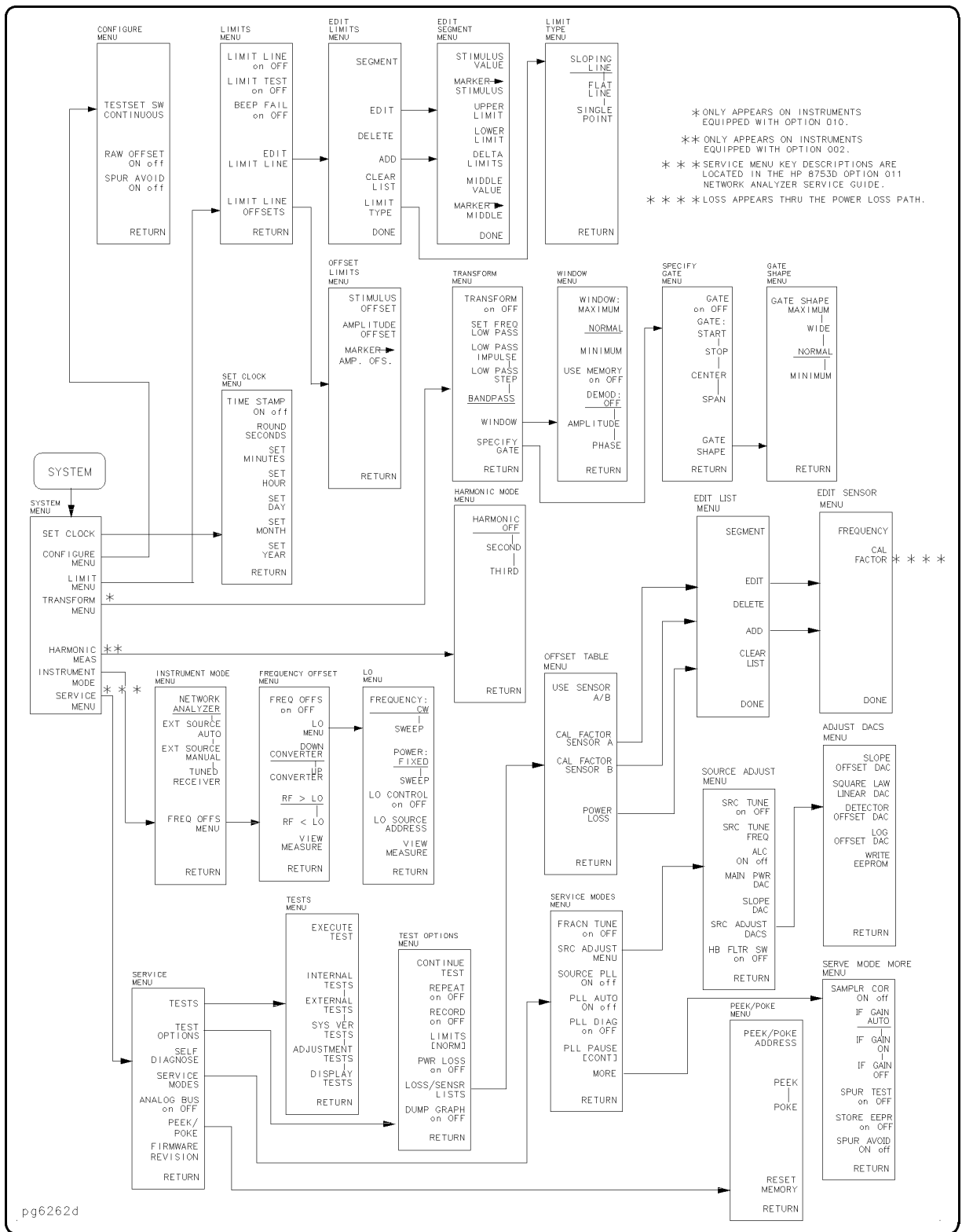

pg6262d

Key Definitions

This chapter contains information on the following topics:

- Softkey and front-panel functions in alphabetical order (includes a brief description of each function)
- Cross reference of programming commands to key functions
- Cross reference of softkeys to front-panel access keys

Note The **SERVICE MENU** keys are not included in this chapter. Service information can be found in the *HP 8753D Network Analyzer Service Guide*.

Where to Look for More Information

Additional information about many of the topics discussed in this chapter is located in the following areas:





- Chapter 2, “Making Measurements,” contains step-by-step procedures for making measurements or using particular functions.
- Chapter 4, “Printing, Plotting, and Saving Measurement Results,” contains instructions for saving to disk or the analyzer internal memory, and printing and plotting displayed measurements.
- Chapter 5, “Optimizing Measurement Results,” describes techniques and functions for achieving the best measurement results.
- Chapter 6, “Application and Operation Concepts,” contains explanatory-style information about many applications and analyzer operation.
- *HP 8753D Network Analyzer Programmer’s Guide* provides a complete description of all HP-IB mnemonics.

Guide Terms and Conventions

The eight keys along the right side of the analyzer display are called softkeys. Their labels are shown on the display. The softkeys appear in shaded boxes in this chapter. For example, **TRANSMISSION**. The labeled keys that are on the front panel of the analyzer are called front-panel keys. The front-panel keys appear in unshaded boxes in this chapter. For example, **SYSTEM**.

Analyzer Functions

This section contains an alphabetical listing of softkey and front-panel functions, and a brief description of each function.

-  is used to add a decimal point to the number you are entering.
-  is used to add a minus sign to the number you are entering.
-  is used to step up the current value of the active function. The analyzer defines the step for different functions. No units terminator is required. For editing a test sequence, this key can be used to scroll through the displayed sequence.
-  is used to step down the current value of the active function. The analyzer defines the step for different functions. No units terminator is required. For editing a test sequence, this key can be used to scroll through the displayed sequence.
-  is used to delete the last entry, or the last digit entered from the numeric keypad. This key can also be used in two ways for modifying a test sequence:
- deleting a single-key command that you may have pressed by mistake, (for example **A/R**)
 - deleting the last digit in a series of entered digits, as long as you haven't yet pressed a terminator, (for example if you pressed **(START) 1 2** but did not press **(G/n)**, etc)
- Δ MODE MENU** goes to the delta marker menu, which is used to read the difference in values between the active marker and a reference marker.
- Δ MODE OFF** turns off the delta marker mode, so that the values displayed for the active marker are absolute values.
- Δ REF = 1** establishes marker 1 as a reference. The active marker stimulus and response values are then shown relative to this delta reference. Once marker 1 has been selected as the delta reference, the softkey label **Δ REF = 1** is underlined in this menu, and the marker menu is returned to the screen. In the marker menu, the first key is now labeled **MARKER Δ REF = 1**. The notation "ΔREF=1" appears at the top right corner of the graticule.
- Δ REF = 2** makes marker 2 the delta reference. Active marker stimulus and response values are then shown relative to this reference.

Δ REF = 3	makes marker 3 the delta reference.
Δ REF = 4	makes marker 4 the delta reference.
Δ REF = 5	makes marker 5 the delta reference.
Δ REF = Δ FIXED MKR	sets a user-specified fixed reference marker. The stimulus and response values of the reference can be set arbitrarily, and can be anywhere in the display area. Unlike markers 1 to 5, the fixed marker need not be on the trace. The fixed marker is indicated by a small triangle Δ , and the active marker stimulus and response values are shown relative to this point. The notation " Δ REF= Δ " is displayed at the top right corner of the graticule.
	Pressing this softkey turns on the fixed marker. Its stimulus and response values can then be changed using the fixed marker menu, which is accessed with the FIXED MKR POSITION softkey described below. Alternatively, the fixed marker can be set to the current active marker position, using the MKR ZERO softkey in the marker menu.
1/S	expresses the data in inverse S-parameter values, for use in amplifier and oscillator design.
A	measures the absolute power amplitude at input A.
A/B	calculates and displays the complex ratio of input A to input B.
A/R	calculates and displays the complex ratio of the signal at input A to the reference signal at input R.
ACTIVE ENTRY	puts the name of the active entry in the display title.
ACTIVE MRK MAGNITUDE	puts the active marker magnitude in the display title.
ADAPTER: COAX	selects coaxial as the type of port used in adapter removal calibration.
ADAPTER: WAVEGUIDE	selects waveguide as the type of port used in adapter removal calibration.
ADAPTER DELAY	is used to enter the value of electrical delay of the adapter used in adapter removal calibration.
ADAPTER REMOVAL	provides access to the adapter removal menu.
ADD	displays the edit segment menu and adds a new segment to the end of the list. The new segment is initially a duplicate of the segment indicated by the pointer > and selected with the SEGMENT softkey.
ADDRESS: 8753	sets the HP-IB address of the analyzer, using the entry controls. There is no physical address switch to set in the analyzer.
ADDRESS: CONTROLLER	sets the HP-IB address the analyzer will use to communicate with the external controller.
ADDRESS: DISK	sets the HP-IB address the analyzer will use to communicate with an external HP-IB disk drive.

ADDRESS: P MTR/HPIB	sets the HP-IB address the analyzer will use to communicate with the power meter used in service routines.
ADJUST DISPLAY	presents a menu for adjusting display intensity, colors, and accessing save and recall functions for modified LCD color sets.
ADJUSTMENT TESTS	leads to the beginning of the adjustment tests. These tests generate correction constants that are used by the analyzer.
ALL SEGS SWEEP	retrieves the full frequency list sweep.
ALTERNATE A and B	measures only one input per frequency sweep, in order to reduce spurious signals. Thus, this mode optimizes the dynamic range for all four S-parameter measurements.
AMPLITUDE OFFSET	adds or subtracts an offset in amplitude value. This allows limits already defined to be used for testing at a different response level. For example, if attenuation is added to or removed from a test setup, the limits can be offset an equal amount. Use the entry block controls to specify the offset.
ANALOG IN Aux Input	displays a dc or low frequency ac auxiliary voltage on the vertical axis, using the real format. An external signal source such as a detector or function generator can be connected to the rear panel AUXILIARY INPUT connector.
ASSERT SRQ	sets the sequence bit in the Event Status Register, which can be used to generate an SRQ (service request) to the system controller.
AUTO FEED ON off	turns the plotter auto feed function on or off when in the define plot menu. It turns the printer auto feed on or off when in the define print menu.
AUTO SCALE	brings the trace data in view on the display with one keystroke. Stimulus values are not affected, only scale and reference values. The analyzer determines the smallest possible scale factor that will put all displayed data onto 80% of the vertical graticule. The reference value is chosen to put the trace in center screen, then rounded to an integer multiple of the scale factor.
AUX OUT on OFF	allows you to monitor the analog bus nodes (except nodes 1,2,3,4,9,10,12) with external equipment. To do this, connect the equipment to the AUX INPUT BNC connector on the rear panel.
AVERAGING FACTOR	makes averaging factor the active function. Any value up to 999 can be used. The algorithm used for averaging is: $A(n) = S(n)/F + (1 - 1/F) \times A(n - 1)$ <p>where</p> <p>A(n) = current average</p> <p>S(n) = current measurement</p> <p>F = average factor</p>
AVERAGING on OFF	turns the averaging function on or off for the active channel. "Avg" is displayed in the status notations area at the left of the display, together with the sweep count for the averaging factor,

when averaging is on. The sweep count for averaging is reset to 1 whenever an instrument state change affecting the measured data is made.

At the start of the averaging or following **AVERAGING RESTART**, averaging starts at 1 and averages each new sweep into the trace until it reaches the specified averaging factor. The sweep count is displayed in the status notations area below “Avg” and updated every sweep as it increments. When the specified averaging factor is reached, the trace data continues to be updated, weighted by that averaging factor.

AVERAGING RESTART

averaging starts at 1 and averages each new sweep into the trace until it reaches the specified averaging factor. The sweep count is displayed in the status notations area below “Avg” and updated every sweep as it increments.

AVG

is used to access three different noise reduction techniques: sweep-to-sweep averaging, display smoothing, and variable IF bandwidth. Any or all of these can be used simultaneously. Averaging and smoothing can be set independently for each channel, and the IF bandwidth can be set independently if the stimulus is uncoupled.

B

measures the absolute power amplitude at input B.

B/R

calculates and displays the complex ratio of input B to input R.

BACK SPACE

deletes the last character entered.

BACKGROUND INTENSITY

sets the background intensity of the LCD as a percent of white. The factory-set default value is stored in non-volatile memory.

BANDPASS

(Option 010 only) sets the time-domain bandpass mode.

BEEP DONE ON off

toggles an annunciator which sounds to indicate completion of certain operations such as calibration or instrument state save.

BEEP FAIL on OFF

turns the limit fail beeper on or off. When limit testing is on and the fail beeper is on, a beep is sounded each time a limit test is performed and a failure detected. The limit fail beeper is independent of the warning beeper and the operation complete beeper.

BEEP WARN on OFF

toggles the warning annunciator. When the annunciator is on it sounds a warning when a cautionary message is displayed.

BLANK DISPLAY

switches off the analyzer’s display. This feature may be helpful in prolonging the life of the LCD in applications where the analyzer is left unattended (such as in an automated test system). Pressing any front panel key will restore the default display operation.

BRIGHTNESS

adjusts the brightness of the color being modified. See Adjusting Color for an explanation of using this softkey for color modification of display attributes.

CO

is used to enter the C0 term in the definition of an OPEN standard in a calibration kit, which is the constant term of the cubic polynomial and is scaled by 10^{-15} .

C1	is used to enter the C1 term, expressed in F/Hz (Farads/Hz) and scaled by 10^{-27} .
C2	is used to enter the C2 term, expressed in F/Hz ² and scaled by 10^{-36} .
C3	is used to enter the C3 term, expressed in F/Hz ³ and scaled by 10^{-45} .
CAL	key leads to a series of menus to perform measurement calibrations for vector error correction (accuracy enhancement), and for specifying the calibration standards used. The CAL key also leads to softkeys which activate interpolated error correction and power meter calibration.
CAL FACTOR	accepts a power sensor calibration factor % for the segment.
CAL FACTOR SENSOR A	brings up the segment modify menu and segment edit (calibration factor menu) which allows you to enter a power sensor's calibration factors. The calibration factor data entered in this menu will be stored for power sensor A.
CAL FACTOR SENSOR B	brings up the segment modify menu and segment edit (calibration factor menu) which allows you to enter a power sensor's calibration factors. The calibration factor data entered in this menu will be stored for power sensor B.
CAL KIT	leads to the select cal kit menu, which is used to select one of the default calibration kits available for different connector types. This, in turn, leads to additional menus used to define calibration standards other than those in the default kits (refer to Modifying Calibration Kits.) When a calibration kit has been specified, its connector type is displayed in brackets in the softkey label.
CAL KIT []	selects the cal kit menu.
CAL KIT: 2.4mm	selects the HP 85056A/D cal kit.
CAL KIT: 2.92*	selects the HP 85056K cal kit.
CAL KIT: 2.92mm	selects the 2.92 mm cal kit model.
CAL KIT: 3.5mmC	selects the HP 85033C cal kit.
CAL KIT: 3.5mmD	selects the HP 85033D cal kit.
CAL KIT: TRL 3.5mm	selects the HP 85052C TRL cal kit.
CAL KIT: 7mm	selects the HP 85031B cal kit.
CAL KIT: N 50Ω	selects the HP 85032B cal kit.
CAL KIT: N 75Ω	selects the HP 85036B/E cal kit.
CAL KIT: USER KIT	selects a kit other than those offered by Hewlett-Packard.
CAL Z0: LINE Z0	this default selection establishes the TRL/LRM LINE/MATCH standard as the characteristic impedance.
CAL Z0: SYSTEM Z0	allows you to modify the characteristic impedance of the system for TRL/LRM calibration.

CALIBRATE MENU

leads to the calibration menu, which provides several accuracy enhancement procedures ranging from a simple frequency response calibration to a full two-port calibration. At the completion of a calibration procedure, this menu is returned to the screen, correction is automatically turned on, and the notation **Cor** or **C2** is displayed at the left of the screen.

CALIBRATE: NONE

is underlined if no calibration has been performed or if the calibration data has been cleared. Unless a calibration is saved in memory, the calibration data is lost on instrument preset, power on, instrument state recall, or if stimulus values are changed.

CENTER

is used, along with the **SPAN** key, to define the frequency range of the stimulus. When the **CENTER** key is pressed, its function becomes the active function. The value is displayed in the active entry area, and can be changed with the knob, step keys, or numeric keypad.

CENTER

sets the center frequency of a subsweep in a list frequency sweep.

CHAN 1

allows you to select channel 1 as the active channel. The active channel is indicated by an amber LED adjacent to the corresponding channel key. The front panel keys allow you to control the active channel, and all of the channel-specific functions you select apply to the active channel.

CH1 DATA []

brings up the printer color selection menu. The channel 1 data trace default color is magenta for color prints.

CH1 DATA LIMIT LN

selects channel 1 data trace and limit line for display color modification.

CH1 MEM

selects channel 1 memory trace for display color modification.

CH1 MEM []

brings up the printer color selection menu. The channel 1 memory trace default color is green for color prints.

CHAN 2

allows you to select channel 2 as the active channel. The active channel is indicated by an amber LED adjacent to the corresponding channel key. The front panel keys allow you to control the active channel, and all of the channel-specific functions you select apply to the active channel.

CH2 DATA []

brings up the printer color selection menu. The channel 2 data trace default color is blue for color prints.

CH2 DATA LIMIT LN

selects channel 2 data trace and limit line for display color modification.

CH2 MEM []

brings up the printer color selection menu. The channel 2 memory trace default color is red for color prints.

CH2 MEM REF LINE

selects channel 2 memory and the reference line for display color modification.

CH PWR [COUPLED]

is used to apply the same power levels to each channel.

CH PWR [UNCOUPLED]

is used to apply different power levels to each channel.

CHOP A and B	measures A and B inputs simultaneously for faster measurements.
CLEAR BIT	when the parallel port is configured for GPIO, 8 output bits can be controlled with this key. When this key is pressed, "TTL OUT BIT NUMBER" becomes the active function. This active function must be entered through the keypad number keys, followed by the (x1) key. The bit is cleared when the (x1) key is pressed. Entering numbers larger than 7 will result in bit 7 being cleared, and entering numbers lower than 0 will result in bit 0 being cleared.
CLEAR LIST	deletes all segments in the list.
CLEAR SEQUENCE	clears a sequence from memory. The titles of cleared sequences will remain in load, store, and purge menus. This is done as a convenience for those who often reuse the same titles.
COAX	defines the standard (and the offset) as coaxial. This causes the analyzer to assume linear phase response in any offsets.
COAXIAL DELAY	applies a linear phase compensation to the trace for use with electrical delay. That is, the effect is the same as if a corresponding length of perfect vacuum dielectric coaxial transmission line was added to the reference signal path.
CONFIGURE	provides access to the configure menu. This menu contains softkeys used to control raw offsets, spur avoidance, and the test set transfer switch.
COLOR	adjusts the degree of whiteness of the color being modified. See "Adjusting Color" for an explanation of using this softkey for color modification of display attributes.
CONFIGURE EXT DISK	provides access to the configure ext disk menu. This menu contains softkeys used to the disk address, unit number, and volume number.
CONTINUE SEQUENCE	resumes a paused sequence.
CONTINUOUS	located under the (MENU) key, is the standard sweep mode of the analyzer, in which the sweep is triggered automatically and continuously and the trace is updated with each sweep.
CONVERSION []	brings up the conversion menu which converts the measured data to impedance (Z) or admittance (Y). When a conversion parameter has been defined, it is shown in brackets under the softkey label. If no conversion has been defined, the softkey label reads CONVERSION [OFF] .
(COPY)	provides access to the menus used for controlling external plotters and printers and defining the plot parameters.
CORRECTION on OFF	turns error correction on or off. The analyzer uses the most recent calibration data for the displayed parameter. If the stimulus state has been changed since calibration, the original state is recalled, and the message "SOURCE PARAMETERS CHANGED" is displayed.
COUNTER: ANALOG BUS	switches the counter to count the analog bus.

COUNTER: DIV FRAC N	switches the counter to count the A14 fractional-N VCO frequency after it has been divided down to 100 kHz for phase-locking the VCO.
COUNTER: FRAC N	switches the counter to count the A14 fractional-N VCO frequency at the node shown on the overall block diagram.
COUNTER: OFF	switches the internal counter off and removes the counter display from the LCD.
COUPLED CH on OFF	toggles the channel coupling of stimulus values. With COUPLED CH ON (the preset condition), both channels have the same stimulus values (the inactive channel takes on the stimulus values of the active channel).
CW FREQ	is used to set the frequency for power sweep and CW time sweep modes. If the instrument is not in either of these two modes, it is automatically switched into CW time mode.
CW TIME	turns on a sweep mode similar to an oscilloscope. The analyzer is set to a single frequency, and the data is displayed versus time. The frequency of the CW time sweep is set with CW FREQ in the stimulus menu.
D2/D1 to D2 on OFF	this math function ratios channels 1 and 2, and puts the results in the channel 2 data array. Both channels must be on and have the same number of points. Refer to Chapter 2, "Making Measurements" for information on how to use this function to make gain compression measurements.
DATA and MEMORY	displays both the current data and memory traces.
DATA ARRAY on OFF	specifies whether or not to store the error-corrected data on disk with the instrument state.
DATA/MEM	divides the data by the memory, normalizing the data to the memory, and displays the result. This is useful for ratio comparison of two traces, for instance in measurements of gain or attenuation.
DATA - MEM	subtracts the memory from the data. The vector subtraction is performed on the complex data. This is appropriate for storing a measured vector error, for example directivity, and later subtracting it from the device measurement.
DATA → MEMORY	stores the current active measurement data in the memory of the active channel. It then becomes the memory trace, for use in subsequent math manipulations or display. If a parameter has just been changed and the * status notation is displayed at the left of the display, the data is not stored in memory until a clean sweep has been executed. The gating and smoothing status of the trace are stored with the measurement data.
DATA ONLY on OFF	stores only the measurement data of the device under test to a disk file. The instrument state and calibration are not stored. This is faster than storing with the instrument state, and uses less disk space. It is intended for use in archiving data that will later be used with an external controller, and cannot be read back by the analyzer.
DECISION MAKING	presents the sequencing decision making menu.

DECR LOOP COUNTER	decrements the value of the loop counter by 1.
DEFAULT COLORS	returns all the display color settings back to the factory-set default values that are stored in non-volatile memory.
DEFAULT PLOT SETUP	resets the plotting parameters to their default values.
DEFAULT PRNT SETUP	resets the printing parameters to their default values.
DEFINE DISK-SAVE	leads to the define save menu. Use this menu to specify the data to be stored on disk in addition to the instrument state.
DEFINE PLOT	leads to a sequence of three menus. The first defines which elements are to be plotted and the auto feed state. The second defines which pen number is to be used with each of the elements (these are channel dependent.) The third defines the line types (these are channel dependent), plot scale, and plot speed.
DEFINE PRINT	leads to the define print menu. This menu defines the printer mode (monochrome or color) and the auto-feed state.
DEFINE STANDARD	makes the standard number the active function, and brings up the define standard menus. The standard number (1 to 8) is an arbitrary reference number used to reference standards while specifying a class.
DELAY	selects the group delay format, with marker values given in seconds.
DELAY/THRU	defines the standard type as a transmission line of specified length, for calibrating transmission measurements.
DELETE	Deletes the segment indicated by the pointer.
DELETE ALL FILES	deletes all files.
DELETE FILE	deletes a selected file.
DELTA LIMITS	sets the limits an equal amount above and below a specified middle value, instead of setting upper and lower limits separately. This is used in conjunction with <code>MIDDLE VALUE</code> or <code>MARKER → MIDDLE</code> , to set limits for testing a device that is specified at a particular value plus or minus an equal tolerance. For example, a device may be specified at 0 dB ±3 dB. Enter the delta limits as 3 dB and the middle value as 0 dB.
DEMODO: AMPLITUDE	(Option 010 only) amplitude demodulation for CW time transform measurements.
DEMODO: OFF	(Option 010 only) turns time domain demodulation off.
DEMODO: PHASE	(Option 010 only) phase demodulation for CW TIME transform measurements.
DIRECTORY SIZE	lets you specify the number of directory files to be initialized on a disk. This is particularly useful with a hard disk, where you may want a directory larger than the default 256 files, or with a floppy disk you may want to reduce the directory to allow extra space for data files. The number of directory files must be a multiple of 8. The minimum number is 8, and there

	is no practical maximum limit. Set the directory size before initializing a disk.
DISK UNIT NUMBER	specifies the number of the disk unit in the disk drive that is to be accessed in an external disk store or load routine. This is used in conjunction with the HP-IB address of the disk drive, and the volume number, to gain access to a specific area on a disk. The access hierarchy is HP-IB address, disk unit number, disk volume number.
DISP MKRS ON off	displays response and stimulus values for all markers that are turned on. Available only if no marker functions are on.
DISPLAY	provides access to a series of menus for instrument and active channel display functions. The first menu defines the displayed active channel trace in terms of the mathematical relationship between data and trace memory. Other functions include dual channel display (overlaid or split), display intensity, color selection, active channel display title, and frequency blanking.
DISPLAY: DATA	displays the current measurement data for the active channel.
DISPLAY TESTS	leads to a series of service tests for the display.
DO BOTH FWD + REV	activates both forward and reverse calibration measurements from selected calibration menus.
DO SEQUENCE	has two functions: <ul style="list-style-type: none"> ■ It shows the current sequences in memory. To run a sequence, press the softkey next to the desired sequence title. ■ When entered into a sequence, this command performs a one-way jump to the sequence residing in the specified sequence position (SEQUENCE 1 through 6). DO SEQUENCE jumps to a softkey position, not to a specific sequence title. Whatever sequence is in the selected softkey position will run when the DO SEQUENCE command is executed. This command prompts the operator to select a destination sequence position.
DONE 1-PORT CAL	finishes one-port calibration (after all standards are measured) and turns error correction on.
DONE 2-PORT CAL	finishes two-port calibration (after all standards are measured) and turns error correction on.
DONE RESP ISOL'N CAL	finishes response and isolation calibration (after all standards are measured) and turns error correction on.
DONE RESPONSE	finishes response calibration (after all standards are measured) and turns error correction on.
DONE SEQ MODIFY	terminates the sequencing edit mode.
DONE TRL/LRM	finishes TRL/LRM two-port calibration (after all standards are measured) and turns error correction on.
DOWN CONVERTER	sets the analyzer's source higher than the analyzer's receiver for making measurements in frequency offset mode.

<code>DUAL CH on OFF</code>	toggles between display of both measurement channels or the active channel only. This is used in conjunction with <code>SPLIT DISP ON off</code> in the display more menu to display both channels. With <code>SPLIT DISP OFF</code> the two traces are overlaid on a single graticule.
<code>DUPLICATE SEQUENCE</code>	duplicates a sequence currently in memory into a different softkey position. Duplicating a sequence is straightforward. Follow the prompts on the analyzer screen. This command does not affect the original sequence.
<code>EACH SWEEP</code>	Power meter calibration occurs on each sweep. Each measurement point is measured by the power meter, which provides the analyzer with the actual power reading. The analyzer corrects the power level at that point. The number of measurement/correction iterations performed on each point is determined by the <code>NUMBER OF READINGS</code> softkey. This measurement mode sweeps slowly, especially when the measured power is low. Low power levels require more time for the power meter to settle. The power meter correction table in memory is updated after each sweep. This table can be read or changed via HP-IB.
<code>EDIT LIMIT LINE</code>	displays a table of limit segments on the LCD, superimposed on the trace. The edit limits menu is presented so that limits can be defined or changed. It is not necessary for limit lines or limit testing to be on while limits are defined.
<code>EDIT LIST</code>	presents the edit list menu. This is used in conjunction with the edit subsweep menu to define or modify the frequency sweep list. The list frequency sweep mode is selected with the <code>LIST FREQ</code> softkey described below.
<code>ELECTRICAL DELAY</code>	adjusts the electrical delay to balance the phase of the DUT. It simulates a variable length lossless transmission line, which can be added to or removed from a receiver input to compensate for interconnecting cables, etc. This function is similar to the mechanical or analog "line stretchers" of other network analyzers. Delay is annotated in units of time with secondary labeling in distance for the current velocity factor.
<code>EMIT BEEP</code>	causes the instrument to beep once.
<code>END OF LABEL</code>	terminates the HP-GL "LB" command.
<code>END SWEEP HIGH PULSE</code>	sets the TTL output on the test set interconnect to normally high with a 10 μ s pulse high at the end of each sweep.
<code>END SWEEP LOW PULSE</code>	sets the TTL output on the test set interconnect to normally low with a 10 μ s pulse low at the end of each sweep.
<code>ERASE TITLE</code>	deletes the entire title.
<code>EXECUTE TEST</code>	runs the selected service test.
<code>EXT SOURCE AUTO</code>	selects the auto external source mode.
<code>EXT SOURCE MANUAL</code>	selects the manual external source mode.

<code>EXT TRIG ON POINT</code>	is similar to the trigger on sweep, but triggers each data point in a sweep.
<code>EXT TRIG ON SWEEP</code>	is used when the sweep is triggered on an externally generated signal connected to the rear panel EXT TRIGGER input. External trigger mode is allowed in every sweep mode.
<code>EXTENSION INPUT A</code>	Use this feature to add electrical delay (in seconds) to extend the reference plane at input A to the end of the cable. This is used for any input measurements including S-parameters.
<code>EXTENSION INPUT B</code>	adds electrical delay to the input B reference plane for any B input measurements including S-parameters.
<code>EXTENSION PORT 1</code>	extends the reference plane for measurements of S_{11} , S_{21} , and S_{12} .
<code>EXTENSION PORT 2</code>	extends the reference plane for measurements of S_{22} , S_{12} , and S_{21} .
<code>EXTENSIONS on OFF</code>	toggles the reference plane extension mode. When this function is on, all extensions defined above are enabled; when off, none of the extensions are enabled.
<code>EXTERNAL DISK</code>	selects an (optional) external disk drive for SAVE/RECALL.
<code>EXTERNAL TESTS</code>	leads to a series of service tests.
<code>FILETITLE FILE0</code>	appears during sequence modification, when external disk is selected. FILE0 is the default name. A new name can be entered when you save the state to disk.
<code>FILE NAME FILE0</code>	supplies a name for the saved istate and or data file. Brings up the TITLE FILE MENU.
<code>FILE UTILITIES</code>	provides access to the file utilities menu.
<code>FIXED</code>	defines the load in a calibration kit as a fixed (not sliding) load.
<code>FIXED MKR AUX VALUE</code>	is used only with a polar or Smith format. It changes the auxiliary response value of the fixed marker. This is the second part of a complex data pair, and applies to a magnitude/phase marker, a real/imaginary marker, an $R+jX$ marker, or a $G+jB$ marker. Fixed marker auxiliary response values are always uncoupled in the two channels. To read absolute active marker auxiliary values following a <code>MKR ZERO</code> operation, the auxiliary value can be reset to zero.
<code>FIXED MKR POSITION</code>	leads to the fixed marker menu, where the stimulus and response values for a fixed reference marker can be set arbitrarily.
<code>FIXED MKR STIMULUS</code>	changes the stimulus value of the fixed marker. Fixed marker stimulus values can be different for the two channels if the channel markers are uncoupled using the marker mode menu. To read absolute active marker stimulus values following a <code>MKR ZERO</code> operation, the stimulus value can be reset to zero.
<code>FIXED MKR VALUE</code>	changes the response value of the fixed marker. In a Cartesian format this is the y-axis value. In a polar or Smith chart format with a magnitude/phase marker, a real/imaginary marker, an

R+jX marker, or a G+jB marker, this applies to the first part of the complex data pair. Fixed marker response values are always uncoupled in the two channels.

To read absolute active marker response values following a **MKR ZERO** operation, the response value can be reset to zero.

FLAT LINE

defines a flat limit line segment whose value is constant with frequency or other stimulus value. This line is continuous to the next stimulus value, but is not joined to a segment with a different limit value. If a flat line segment is the final segment it terminates at the stop stimulus. A flat line segment is indicated as FL on the table of limits.

FORM FEED

puts a form feed command into the display title.

FORMAT

presents a menu used to select the display format for the data. Various rectangular and polar formats are available for display of magnitude, phase, impedance, group delay, real data, and SWR.

FORMAT ARY on OFF

specifies whether or not to store the formatted data on disk with the instrument state.

FORMAT DISK

brings up a menu for formatting a disk.

FORMAT: DOS

causes subsequent disk initialization to use the DOS disk format.

FORMAT: LIF

causes subsequent disk initialization to use the LIF disk format. **FORMAT: LIF** is the default setting.

FORMAT EXT DISK

initializes media in external drive, and formats the disk using the selected (DOS or LIF) format.

FORMAT INT DISK

initializes media in internal drive, and formats the disk using the selected (DOS or LIF) format.

FORMAT INT MEMORY

clears all internal save registers and associated cal data and memory traces.

FREQ OFFS MENU

leads to the frequency offset menu.

FREQ OFFS on OFF

switches the frequency offset mode on and off.

FREQUENCY

specifies the frequency of a calibration factor or loss value in the power meter cal loss/sensor lists.

FREQUENCY BLANK

blanks the displayed frequency notation for security purposes. Frequency labels cannot be restored except by instrument preset or turning the power off and then on.

FREQUENCY: CW

sets the LO frequency to CW mode for frequency offset.

FREQUENCY: SWEEP

sets the LO frequency to sweep mode for frequency offset.

FULL 2-PORT

provides access to the series of menus used to perform a complete calibration for measurement of all four S-parameters of a two-port device. This is the most accurate calibration for measurements of two-port devices.

FWD ISOL'N ISOL'N STD

measures the forward isolation of the calibration standard.

FWD MATCH (Label Class)	lets you enter a label for the forward match class. The label appears during a calibration that uses this class.
FWD MATCH (Specify Class)	specifies which standards are in the forward match class in the calibration kit.
FWD MATCH THRU	is used to enter the standard numbers for the forward match (thru) calibration. (For default kits, this is the thru.)
FWD TRANS (Label Class)	lets you enter a label for the forward transmission class. The label appears during a calibration that uses this class.
FWD TRANS (Specify Class)	specifies which standards are in the forward transmission class in the calibration kit.
FWD TRANS THRU	measures the forward frequency response in a two-port calibration.
G+jB MKR	displays the complex admittance values of the active marker in rectangular form. The active marker values are displayed in terms of conductance (in Siemens), susceptance, and equivalent capacitance or inductance. Siemens are the international units of admittance, and are equivalent to mhos (the inverse of ohms). The Smith chart graticule is changed to admittance form.
G/n	giga/nano ($10^9 / 10^{-9}$)
GATE on OFF	(Option 010 only) turns gating on or off in time domain mode.
GATE: CENTER	(Option 010 only) allows you to specify the time at the center of the gate.
GATE: SPAN	(Option 010 only) allows you to specify the gate periods.
GATE: START	(Option 010 only) allows you to specify the starting time of the gate.
GATE: STOP	(Option 010 only) allows you to specify the stopping time of the gate.
GATE SHAPE	(Option 010 only) leads to the gate shape menu.
GATE SHAPE MAXIMUM	(Option 010 only) selects the widest time domain gate with the smallest passband ripple.
GATE SHAPE MINIMUM	(Option 010 only) selects the narrowest time domain gate with the largest passband ripple.
GATE SHAPE NORMAL	(Option 010 only) selects an intermediate time domain gate.
GATE SHAPE WIDE	(Option 010 only) selects an intermediate time domain gate.
GET SEQ TITLES	copies the sequence titles currently in memory into the six softkey positions.
GOSUB SEQUENCE	calls sub-routines in sequencing.
GRAPHICS on OFF	specifies whether or not to store display graphics on disk with the instrument state.
GRATICULE []	brings up the color definition menu. The graticule trace default color is cyan.

GRATICULE TEXT	selects the graticule and a portion of softkey text (where there is a choice of a feature being on or off) for color modification. For example: <code>FREQUENCY BLANK on OFF</code> .
HARMONIC MEAS	(Option 002 only) leads to the harmonics menu. This feature phase locks to the 2nd or 3rd harmonic of the fundamental signal. Measured harmonics cannot exceed the frequency range of the analyzer receiver.
HARMONIC OFF	(Option 002 only) turns off the harmonic measurement mode.
HARMONIC SECOND	(Option 002 only) selects measurement of the second harmonic.
HARMONIC THIRD	(Option 002 only) selects measurement of the third harmonic.
HELP ADAPT REMOVAL	provides an on-line quick reference guide to using the adapter removal technique.
HOLD	freezes the data trace on the display, and the analyzer stops sweeping and taking data. The notation "Hld" is displayed at the left of the graticule. If the * indicator is on at the left side of the display, trigger a new sweep with <code>(SINGLE)</code> .
HP-IB DIAG on off	toggles the HP-IB diagnostic feature (debug mode). This mode should only be used the first time a program is written: if a program has already been debugged, it is unnecessary. When diagnostics are on, the analyzer scrolls a history of incoming HP-IB commands across the display in the title line. Nonprintable characters are represented as π . If a syntax error is received, the commands halt and a pointer \wedge indicates the misunderstood character. To clear a syntax error, refer to the "HP-IB Programming Reference" and "HP-IB Programming Examples" chapters in the <i>HP 8753D Network Analyzer Programmer's Guide</i> .
IF BW []	is used to select the bandwidth value for IF bandwidth reduction. Allowed values (in Hz) are 3700, 3000, 1000, 300, 100, 30, and 10. Any other value will default to the closest allowed value. A narrow bandwidth slows the sweep speed but provides better signal-to-noise ratio. The selected bandwidth value is shown in brackets in the softkey label.
IF LIMIT TEST FAIL	jumps to one of the six sequence positions (SEQUENCE 1 through 6) if the limit test fails. This command executes any sequence residing in the selected position. Sequences may jump to themselves as well as to any of the other sequences in memory. When this softkey is pressed, the analyzer presents a softkey menu showing the six sequence positions and the titles of the sequences located in them. Choose the destination sequence to be called if the limit test fails.
IF LIMIT TEST PASS	jumps to one of the six sequence positions (SEQUENCE 1 through 6) if the limit test passes. This command executes any sequence residing in the selected position. Sequences may jump to themselves as well as to any of the other sequences in memory. When this softkey is pressed, the analyzer presents a softkey menu showing the six sequence positions, and the titles

<code>IF LOOP COUNTER = 0</code>	of the sequences located in them. Choose the sequence to be called if the limit test passes (destination sequence).
<code>IF LOOP < > COUNTER 0</code>	prompts the user to select a destination sequence position (SEQUENCE 1 through 6). When the value of the loop counter reaches zero, the sequence in the specified position will run.
<code>IMAGINARY</code>	prompts the user to select a destination sequence position (SEQUENCE 1 through 6). When the value of the loop counter is no longer zero, the sequence in the specified position will run.
<code>INCR LOOP COUNTER</code>	displays only the imaginary (reactive) portion of the measured data on a Cartesian format. This format is similar to the real format except that reactance data is displayed on the trace instead of impedance data.
<code>INIT DISK? YES</code>	increments the value of the loop counter by 1.
<code>INITIALIZE DISK</code>	initializes the disk unit number and volume number selected in the HP-IB menu, then returns to the disk menu. If more than one hard disk volume is to be initialized, each volume must be selected and initialized individually.
<code>INPUT PORTS</code>	leads to the initialize menu. Before data can be stored on a disk, the disk must be initialized. If you attempt to store without initializing the disk, the message "CAUTION: DISK MEDIUM NOT INITIALIZED" is displayed. The disk format can be selected to be either logical interchange format (LIF), or DOS.
<code>INSTRUMENT MODE</code>	accesses a menu that allows you to measure the R, A, and B channels.
<code>INTENSITY</code>	presents the instrument mode menu. This provides access to the primary modes of operation (analyzer modes).
<code>INTERNAL TESTS</code>	sets the LCD intensity as a percent of the brightest setting. The factory-set default value is stored in non-volatile memory.
<code>INTERNAL DISK</code>	leads to a series of service tests.
<code>INTERNAL MEMORY</code>	selects the analyzer internal disk for the storage device.
<code>INTERPOL on OFF</code>	selects internal non-volatile memory as the storage medium for subsequent save and recall activity.
<code>ISOLATION</code>	turns interpolated error correction on or off. The interpolated error correction feature allows the operator to calibrate the system, then select a subset of the frequency range or a different number of points. Interpolated error correction functions in linear frequency, power sweep and CW time modes. When using the analyzer in linear sweep, it is recommended that the original calibration be performed with at least 67 points per 1 GHz of frequency span.
<code>ISOLATION DONE</code>	leads to the isolation menu.
<code>ISOL'N STD</code>	returns to the two-port cal menu.
	measures the isolation of the device connected to the test port.

ISTATE CONTENTS

describes the selected instrument state file (disk only) translating the various filename prefixes into more descriptive detail.

(k/m)

kilo/milli ($10^3 / 10^{-3}$)

KIT DONE (MODIFIED)

terminates the cal kit modification process, after all standards are defined and all classes are specified. Be sure to save the kit with the `SAVE USER KIT` softkey, if it is to be used later.

LABEL CLASS

leads to the label class menu, to give the class a meaningful label for future reference during calibration.

LABEL CLASS DONE

finishes the label class function and returns to the modify cal kit menu.

LABEL KIT

leads to a menu for constructing a label for the user-modified cal kit. If a label is supplied, it will appear as one of the five softkey choices in the select cal kit menu. The approach is similar to defining a display title, except that the kit label is limited to ten characters.

LABEL STD

The function is similar to defining a display title, except that the label is limited to ten characters.

LEFT LOWER

draws a quarter-page plot in the lower left quadrant of the page.

LEFT UPPER

draws a quarter-page plot in the upper left quadrant of the page.

LIMIT LINE OFFSETS

leads to the offset limits menu, which is used to offset the complete limit set in either stimulus or amplitude value.

LIMIT LINE on OFF

turns limit lines on or off. To define limits, use the `EDIT LIMIT LINE` softkey described below. If limits have been defined and limit lines are turned on, the limit lines are displayed on the LCD for visual comparison of the measured data in all Cartesian formats.

If limit lines are on, they are plotted with the data on a plot, and saved in memory with an instrument state. In a listing of values from the copy menu with limit lines on, the upper limit and lower limit are listed together with the pass or fail margin, as long as other listed data allows sufficient space.

LIMIT MENU

leads to a series of menus used to define limits or specifications with which to compare a test device. Refer to Limit Lines and Limit Testing.

LIMIT TEST on OFF

turns limit testing on or off. When limit testing is on, the data is compared with the defined limits at each measured point. Limit tests occur at the end of each sweep, whenever the data is updated, when formatted data is changed, and when limit testing is first turned on.

Limit testing is available for both magnitude and phase values in Cartesian formats. In polar and Smith chart formats, the value tested depends on the marker mode and is the magnitude or the first value in a complex pair. The message "NO LIMIT

LINES DISPLAYED” is displayed in polar and Smith chart formats if limit lines are turned on.

Five indications of pass or fail status are provided when limit testing is on. A PASS or FAIL message is displayed at the right of the LCD. The trace vector leading to any measured point that is out of limits is set to red at the end of every limit test, both on a displayed plot and a hard copy plot. The limit fail beeper sounds if it is turned on. In a listing of values using the copy menu, an asterisk * is shown next to any measured point that is out of limits. A bit is set in the HP-IB status byte.

LIMIT TEST RESULT

puts the result of a limit test into the display title.

LIMIT TYPE

leads to the limit type menu, where one of three segment types can be selected.

LIN FREQ

activates a linear frequency sweep displayed on a standard graticule with ten equal horizontal divisions. This is the default preset sweep type.

LIN MAG

displays the linear magnitude format. This is a Cartesian format used for unitless measurements such as reflection coefficient magnitude ρ or transmission coefficient magnitude τ , and for linear measurement units. It is used for display of conversion parameters and time domain transform data.

LIN MKR

displays a readout of the linear magnitude and the phase of the active marker. Marker magnitude values are expressed in units; phase is expressed in degrees.

LINE/MATCH

provides access to the Line/Match Menu for TRL/LRM calibration.

LINE TYPE DATA

selects the line type for the data trace plot. The default line type is 7, which is a solid unbroken line.

LINE TYPE MEMORY

selects the line type for the memory trace plot. The default line type is 7.

LIST

provides a tabular listing of all the measured data points and their current values, together with limit information if it is turned on. At the same time, the screen menu is presented, to enable hard copy listings and access new pages of the table. 30 lines of data are listed on each page, and the number of pages is determined by the number of measurement points specified in the stimulus menu.

LIST FREQ

provides a user-definable arbitrary frequency list mode. This list is defined and modified using the edit list menu and the edit subsweep menu. Up to 30 frequency subsweeps (called “segments”) of several different types can be specified, for a maximum total of 1632 points. One list is common to both channels. Once a frequency list has been defined and a measurement calibration performed on the full frequency list, one or all of the frequency segments can be measured and displayed without loss of calibration.

LIST VALUES

provides a tabular listing of all the measured data points and their current values, together with limit information if it is switched on. Thirty lines of data are listed on each page,

LN/MATCH 1	measures the TRL/LRM line or match standard for PORT 1.
LN/MATCH 2	measures the TRL/LRM line or match standard for PORT 2.
LO CONTROL on OFF	turns the LO control mode on and off for frequency offset.
LO MENU	leads to the LO menu. Allows you to configure the external source for frequency offset.
LO SOURCE ADDRESS	shows the HP-IB address of the LO source.
LOAD	defines the standard type as a load (termination). Loads are assigned a terminal impedance equal to the system characteristic impedance Z_0 , but delay and loss offsets may still be added. If the load impedance is not Z_0 , use the arbitrary impedance standard definition.
LOAD NO OFFSET	initiates measurement of a calibration standard load without offset.
LOAD OFFSET	initiates measurement of a calibration standard load with offset.
LOAD SEQ FROM DISK	presents the load sequence from disk menu. Select the desired sequence and the analyzer will load it from disk.
LOCAL	This key is used to return the analyzer to local (front panel) operation from remote (computer controlled) operation. This key will also abort a test sequence or hardcopy print/plot. In this local mode, with a controller still connected on HP-IB, the analyzer can be operated manually (locally) from the front panel. This is the only front panel key that is not disabled when the analyzer is remotely controlled over HP-IB by a computer. The exception to this is when local lockout is in effect: this is a remote command that disables the LOCAL key, making it difficult to interfere with the analyzer while it is under computer control.
LOG FREQ	activates a logarithmic frequency sweep mode. The source is stepped in logarithmic increments and the data is displayed on a logarithmic graticule. This is slower than a continuous sweep with the same number of points, and the entered sweep time may therefore be changed automatically. For frequency spans of less than two octaves, the sweep type automatically reverts to linear sweep.
LOG MAG	displays the log magnitude format. This is the standard Cartesian format used to display magnitude-only measurements of insertion loss, return loss, or absolute power in dB versus frequency.
LOG MKR	displays the logarithmic magnitude value and the phase of the active marker in Polar or Smith chart format. Magnitude values are expressed in dB and phase in degrees. This is useful as a fast method of obtaining a reading of the log magnitude value without changing to log magnitude format.
LOOP COUNTER	displays the current value of the loop counter and allows you to change the value of the loop counter. Enter any number

from 0 to 32767 and terminate with the **(x1)** key. The default value of the counter is zero. This command should be placed in a sequence that is separate from the measurement sequence. For this reason: the measurement sequence containing a loop decision command must call itself in order to function. The **LOOP COUNTER** command must be in a separate sequence or the counter value would always be reset to the initial value.

LOOP COUNTER
(Sequence Filenaming)

inserts the string “[LOOP]” into the filename.

LOSS

accepts a power loss value for a segment in the power meter cal power loss list. This value, for example, could be the difference (in dB) between the coupled arm and through arm of a directional coupler.

LOSS/SENSR LISTS

presents the power loss/sensor lists menu. This menu performs two functions:

- Corrects coupled-arm power loss when a directional coupler is used to sample the RF output.
- Allows calibration factor data to be entered for one or two power sensors.

Each function provides up to 12 separate frequency points, called segments, at which the user may enter a different power loss or calibration factor. The instrument interpolates between the selected points. Two power sensor lists are provided because no single power sensor can cover the frequency range possible with an HP 8753D.

LOW PASS IMPULSE

(Option 010 only) sets the transform to low pass impulse mode, which simulates the time domain response to an impulse input.

LOW PASS STEP

(Option 010 only) sets the transform to low pass step mode, which simulates the time domain response to a step input.

LOWER LIMIT

sets the lower limit value for the start of the segment in a limit line list. If an upper limit is specified, a lower limit must also be defined. If no lower limit is required for a particular measurement, force the lower limit value out of range (for example -500 dB).

(M/μ)

mega/micro (10^6 / 10^{-6})

MANUAL TRG ON POINT

waits for a manual trigger for each point. Subsequent pressing of this softkey triggers each measurement. The annotation “man” will appear at the left side of the display when the instrument is waiting for the trigger to occur. This feature is useful in a test sequence when an external device or instrument requires changes at each point.

(MARKER)

displays an active marker on the screen and provides access to a series of menus to control from one to five display markers for each channel. Markers provide numerical readout of measured values at any point of the trace.

The menus accessed from the **(MARKER)** key provide several basic marker operations. These include special marker modes for different display formats, and a marker delta mode that

displays marker values relative to a specified value or another marker.

MARKER → AMP. OFS.

uses the active marker to set the amplitude offset for the limit lines. Move the marker to the desired middle value of the limits and press this softkey. The limits are then moved so that they are centered an equal amount above and below the marker at that stimulus value.

MARKER → CENTER

changes the stimulus center value to the stimulus value of the active marker, and centers the new span about that value.

MARKER → CW

sets the CW frequency of the analyzer to the frequency of the active marker. This feature is intended for use in automated compression measurements. Test sequences allow the instrument to automatically find a maximum or minimum point on a response trace. The **MARKER → CW** command sets the instrument to the CW frequency of the active marker. When power sweep is engaged, the CW frequency will already be selected.

MARKER → DELAY

adjusts the electrical delay to balance the phase of the DUT. This is performed automatically, regardless of the format and the measurement being made. Enough line length is added to or subtracted from the receiver input to compensate for the phase slope at the active marker position. This effectively flattens the phase trace around the active marker, and can be used to measure electrical length or deviation from linear phase. Additional electrical delay adjustments are required on DUTs without constant group delay over the measured frequency span. Since this feature adds phase to a variation in phase versus frequency, it is applicable only for ratioed inputs.

MARKER → MIDDLE

sets the midpoint for **DELTA LIMITS** using the active marker to set the middle amplitude value of a limit segment. Move the marker to the desired value or device specification, and press this key to make that value the midpoint of the delta limits. The limits are automatically set an equal amount above and below the marker.

MARKER → REFERENCE

makes the reference value equal to the active marker's response value, without changing the reference position. In a polar or Smith chart format, the full scale value at the outer circle is changed to the active marker response value. This softkey also appears in the scale reference menu.

MARKER → SPAN

changes the start and stop values of the stimulus span to the values of the active marker and the delta reference marker. If there is no reference marker, the message "NO MARKER DELTA – SPAN NOT SET" is displayed.

MARKER → START

changes the stimulus start value to the stimulus value of the active marker.

MARKER → STIMULUS

sets the starting stimulus value of a limit line segment using the active marker. Move the marker to the desired starting stimulus value before pressing this key, and the marker stimulus value is entered as the segment start value.

MARKER → STOP

changes the stimulus stop value to the stimulus value of the active marker.

MARKER 1

turns on marker 1 and makes it the active marker. The active marker appears on the display as ∇. The active marker stimulus value is displayed in the active entry area, together with the marker number. If there is a marker turned on, and no other function is active, the stimulus value of the active marker can be controlled with the knob, the step keys, or the numeric keypad. The marker response and stimulus values are displayed in the upper right-hand corner of the screen.

MARKER 2

turns on marker 2 and makes it the active marker. If another marker is present, that marker becomes inactive and is represented on the display as Δ.

MARKER 3

turns on marker 3 and makes it the active marker.

MARKER 4

turns on marker 4 and makes it the active marker.

MARKER 5

turns on marker 5 and makes it the active marker.

MARKER all OFF

turns off all the markers and the delta reference marker, as well as the tracking and bandwidth functions that are accessed with the MKR FCTN key.

MARKER FCTN

key activates a marker if one is not already active, and provides access to additional marker functions. These can be used to quickly change the measurement parameters, to search the trace for specified information, and to analyze the trace statistically.

MARKER MODE MENU

provides access to the marker mode menu, where several marker modes can be selected including special markers for polar and Smith chart formats.

MARKERS: CONTINUOUS

located under the **MARKER** key, interpolates between measured points to allow the markers to be placed at any point on the trace. Displayed marker values are also interpolated. This is the default marker mode.

MARKERS: COUPLED

couple the marker stimulus values for the two display channels. Even if the stimulus is uncoupled and two sets of stimulus values are shown, the markers track the same stimulus values on each channel as long as they are within the displayed stimulus range.

MARKERS: DISCRETE

places markers only on measured trace points determined by the stimulus settings.

MARKERS: UNCOUPLED

allows the marker stimulus values to be controlled independently on each channel.

MAX

moves the active marker to the maximum point on the trace.

MAXIMUM FREQUENCY

is used to define the highest frequency at which a calibration kit standard can be used during measurement calibration. In waveguide, this is normally the upper cutoff frequency of the standard.

MEAS

key provides access to a series of softkey menus for selecting the parameters or inputs to be measured.

MEASURE RESTART

aborts the sweep in progress, then restarts the measurement. This can be used to update a measurement following an adjustment of the device under test. When a full two-port calibration is in use, the **MEASURE RESTART** key will initiate another update of both forward and reverse S-parameter data. This softkey will also override the test set hold mode, which inhibits continuous switching of either the test port transfer switch or step attenuator. The measurement configurations which cause this are described in Test Set Attenuator, Test Port Transfer Switch, and Doubler Switch Protection, at the beginning of this section. This softkey will override the test set hold mode for one measurement.

If the analyzer is taking a number of groups (see Trigger Menu), the sweep counter is reset at 1. If averaging is on, **MEASURE RESTART** resets the sweep-to-sweep averaging and is effectively the same as **AVERAGING RESTART**. If the sweep trigger is in **HOLD** mode, **MEASURE RESTART** executes a single sweep.

MEMORY

displays the trace memory for the active channel. This is the only memory display mode where the smoothing and gating of the memory trace can be changed. If no data has been stored in memory for this channel, a warning message is displayed.

MENU

provides access to a series of menus which are used to define and control all stimulus functions other than start, stop, center, and span. When the **MENU** key is pressed, the stimulus menu is displayed.

MIDDLE VALUE

sets the midpoint for **DELTA LIMITS**. It uses the entry controls to set a specified amplitude value vertically centered between the limits.

MIN

moves the active marker to the minimum point on the trace.

MINIMUM FREQUENCY

is used to define the lowest frequency at which a calibration kit standard can be used during measurement calibration. In waveguide, this must be the lower cutoff frequency of the standard, so that the analyzer can calculate dispersive effects correctly (see **OFFSET DELAY**).

MKR SEARCH []

leads to the marker search menu, which is used to search the trace for a particular value or bandwidth.

MKR ZERO

puts a fixed reference marker at the present active marker position, and makes the fixed marker stimulus and response values at that position equal to zero. All subsequent stimulus and response values of the active marker are then read out relative to the fixed marker. The fixed marker is shown on the display as a small triangle Δ (delta), smaller than the inactive marker triangles. The softkey label changes from **MKR ZERO** to **MKR ZERO Δ REF = Δ** and the notation " Δ REF = Δ " is displayed at the top right corner of the graticule. Marker zero is canceled

	by turning delta mode off in the delta marker menu or turning all the markers off with the ALL OFF softkey.
MODIFY []	leads to the modify cal kit menu, where a default cal kit can be user-modified.
MODIFY COLORS	present a menu for color modification of display elements. Refer to Adjusting Color for information on modifying display elements.
NETWORK ANALYZER	sets the analyzer to network analyzer mode.
NEW SEQ/MODIFY SEQ	activates the sequence edit mode and presents the new/modify sequence menu with a list of sequences that can be created or modified.
NEWLINE	puts a new line command into the display title.
NEXT PAGE	steps forward through a tabular list of data page-by-page.
NUMBER OF GROUPS	triggers a user-specified number of sweeps, and returns to the hold mode. This function can be used to override the test set hold mode, which protects the electro-mechanical transfer switch and attenuator against continuous switching. This is explained fully in the Test Set Attenuator description in the “Application and Operation Concepts” chapter, in this manual. If averaging is on, the number of groups should be at least equal to the averaging factor selected to allow measurement of a fully averaged trace. Entering a number of groups resets the averaging counter to 1.
NUMBER OF POINTS	is used to select the number of data points per sweep to be measured and displayed. Using fewer points allows a faster sweep time but the displayed trace shows less horizontal detail. Using more points gives greater data density and improved trace resolution, but slows the sweep and requires more memory for error correction or saving instrument states. The possible values that can be entered for number of points are 3, 11, 26, 51, 101, 201, 401,801, and 1601. The number of points can be different for the two channels if the stimulus values are uncoupled. In list frequency sweep, the number of points displayed is the total number of frequency points for the defined list (see Sweep Type Menu).
NUMBER OF READINGS	determines the number of measurement/correction iterations performed on each point in a power meter calibration. This feature helps eliminate residual power errors after the initial correction. The amount of residual error is directly proportional to the magnitude of the initial correction. The user should initially set the source power so that it is approximately correct at the device under test. If power uncertainty at the device under test is expected to be greater than a few dB, it is recommended that the number of readings be greater than 1.
OFFSET	selects the calibration standard load as being offset.

OFFSET DELAY	is used to specify the one-way electrical delay from the measurement (reference) plane to the standard, in seconds (s). (In a transmission standard, offset delay is the delay from plane to plane.) Delay can be calculated from the precise physical length of the offset, the permittivity constant of the medium, and the speed of light.
OFFSET LOADS DONE	completes the selection in the Offset Load Menu.
OFFSET LOSS	is used to specify energy loss, due to skin effect, along a one-way length of coax offset. The value of loss is entered as ohms/nanosecond (or Giga ohms/second) at 1 GHz. (Such losses are negligible in waveguide, so enter 0 as the loss offset.)
OFFSET Z0	is used to specify the characteristic impedance of the coax offset. (Note: This is not the impedance of the standard itself.) (For waveguide, the offset impedance should always be assigned a value equal to the system Z0.)
OMIT ISOLATION	is used to omit the isolation portion of the calibration.
ONE-PATH 2-PORT	leads to the series of menus used to perform a high-accuracy two-port calibration without an S-parameter test set. This calibration procedure effectively removes directivity, source match, load match, isolation, reflection tracking, and transmission tracking errors in one direction only. Isolation correction can be omitted for measurements of devices with limited dynamic range. (The device under test must be manually reversed between sweeps to accomplish measurement of both input and output responses.) The required standards are a short, an open, a thru, and an impedance-matched load.
ONE SWEEP	This mode does not measure each sweep, but corrects each point with the data currently in the power meter correction table.
OP PARMS (MKRS etc)	provides a tabular listing on the analyzer display of the key parameters for both channels. The screen menu is presented to allow hard copy listings and access new pages of the table. Four pages of information are supplied. These pages list operating parameters, marker parameters, and system parameters that relate to control of peripheral devices rather than selection of measurement parameters.
OPEN	defines the standard type as an open, used for calibrating reflection measurements. Opens are assigned a terminal impedance of infinite ohms, but delay and loss offsets may still be added. Pressing this key also brings up a menu for defining the open, including its capacitance.
P MTR/HPIB TO TITLE	gets data from an HP-IB device set to the address at which the analyzer expects to find a power meter. The data is stored in a title string. The analyzer must be in system controller or pass control mode.
PARALL IN BIT NUMBER	while creating a sequence, this softkey will insert a command that selects the single bit (0 to 4) that a sequence will be looking for from the GPIO bus.

<code>PARALL IN IF BIT H</code>	while creating a sequence, this softkey inserts a command to jump to another sequence if the single input selected is in a high state.
<code>PARALL IN IF BIT L</code>	while creating a sequence, this softkey inserts a command to jump to another sequence if the single input selected is in a low state.
<code>PARALLEL</code>	sets the printer or plotter port to parallel.
<code>PARALLEL [COPY/GPIO]</code>	toggles the parallel output port between the copy and GPIO output modes.
<code>PARALLEL OUT ALL</code>	allows you to input a number (0 to 255) in base 10, and outputs it to the bus as binary, when the parallel port is in GPIO mode.
<code>PAUSE</code>	pauses the sequence so the operator can perform a needed task, such as changing the DUT, changing the calibration standard, or other similar task. Press <code>CONTINUE SEQUENCE</code> when ready.
<code>PAUSE TO SELECT</code>	when editing a sequence, <code>PAUSE TO SELECT</code> appears when you press <code>DO SEQUENCE</code> . When placed in a sequence, it presents the menu of up to 6 available sequences (softkeys containing non-empty sequences). The message “CHOOSE ONE OF THESE SEQUENCES” is displayed and the present sequence is stopped. If the operator selects one of the sequences, that sequence is executed. Any other key can be used to exit this mode. This function is not executed if used during modify mode and does nothing when operated manually. This softkey is not visible on the display, and the function is not available, unless programmed into analyzer memory.
<code>PEN NUM DATA</code>	selects the number of the pen to plot the data trace. The default pen for channel 1 is pen number 2, and for channel 2 is pen number 3.
<code>PEN NUM GRATICULE</code>	selects the number of the pen to plot the graticule. The default pen for channel 1 is pen number 1, and for channel 2 is pen number 1.
<code>PEN NUM MARKER</code>	selects the number of the pen to plot both the markers and the marker values. The default pen for channel 1 is pen number 7, and for channel 2 is pen number 7.
<code>PEN NUM MEMORY</code>	selects the number of the pen to plot the memory trace. The default pen for channel 1 is pen number 5, and for channel 2 is pen number 6.
<code>PEN NUM TEXT</code>	selects the number of the pen to plot the text. The default pen for channel 1 is pen number 7, and for channel 2 is pen number 7.
<code>PHASE OFFSET</code>	adds or subtracts a phase offset that is constant with frequency (rather than linear). This is independent of <code>MARKER → DELAY</code> and <code>ELECTRICAL DELAY</code> .
<code>PHASE</code>	(Option 010 only) displays a Cartesian format of the phase portion of the data, measured in degrees. This format displays the phase shift versus frequency.

<code>PLOT</code>	makes a hard copy plot of one page of the tabular listing on the display, using a compatible HP plotter connected to the analyzer through HP-IB. This method is appropriate when speed of output is not a critical factor.
<code>PLOT DATA ON off</code>	specifies whether the data trace is to be drawn (on) or not drawn (off) on the plot.
<code>PLOT GRAT ON off</code>	specifies whether the graticule and the reference line are to be drawn (on) or not drawn (off) on the plot. Turning <code>PLOT GRAT ON</code> and all other elements off is a convenient way to make preplotted grid forms. However, when data is to be plotted on a preplotted form, <code>PLOT GRAT OFF</code> should be selected.
<code>PLOT MEM ON off</code>	specifies whether the memory trace is to be drawn (on) or not drawn (off) on the plot. Memory can only be plotted if it is displayed (refer to "Display Menu" in Chapter 6).
<code>PLOT MKR ON off</code>	specifies whether the markers and marker values are to be drawn (on) or not drawn (off) on the plot.
<code>PLOT NAME PLOTFILE</code>	supplies a name for the plot file generated by a PLOT to disk. Brings up the TITLE FILE MENU.
<code>PLOT SPEED []</code>	toggles between fast and slow speeds.
<code>PLOT TEXT ON off</code>	selects plotting of all displayed text except the marker values, softkey labels, and display listings such as the frequency list table or limit table. (Softkey labels can be plotted under the control of an external controller. Refer to the Introductory Programming Guide.)
<code>PLOTTER BAUD RATE</code>	sets the serial port data transmission speed for plots.
<code>PLOTTER FORM FEED</code>	sends a page eject command to the plotter.
<code>PLOTTER PORT</code>	sets the HP-IB address the analyzer will use to communicate with the plotter.
<code>PLTR PORT: DISK</code>	directs plots to the selected disk (internal or external).
<code>PLTR PORT: HPIB</code>	directs plots to the HP-IB port and sets the HP-IB address the analyzer will use to communicate with the plotter.
<code>PLTR PORT: PARALLEL</code>	configures the analyzer for a plotter that has a parallel (centronics) interface.
<code>PLTR PORT: SERIAL</code>	configures the analyzer for a plotter that has a serial (RS-232) interface.
<code>PLTR TYPE [PLOTTER]</code>	selects a pen plotter such as the HP 7440A, HP 7470A, HP 7475A, or HP 7550B as the plotter type.
<code>PLTR TYPE [HPGL PRT]</code>	selects a PCL5 compatible printer, which supports HP-GL/2, such as the LaserJet III or LaserJet 4 for a monochrome plotter type, or the DeskJet 1200C for a color plotter type.
<code>POLAR</code>	displays a polar format. Each point on the polar format corresponds to a particular value of both magnitude and phase. Quantities are read vectorally: the magnitude at any point is determined by its displacement from the center (which has zero

value), and the phase by the angle counterclockwise from the positive x-axis. Magnitude is scaled in a linear fashion, with the value of the outer circle usually set to a ratio value of 1. Since there is no frequency axis, frequency information is read from the markers.

POLAR MKR MENU

leads to a menu of special markers for use with a polar format.

PORT EXTENSIONS

goes to the reference plane menu, which is used to extend the apparent location of the measurement reference plane or input.

PORT PWR [COUPLED]

is used to set the same power levels at each port.

PORT PWR [UNCOUPLED]

allows you to set different power levels at each port.

POWER

makes power level the active function and sets the RF output power level of the analyzer's internal source. The analyzer will detect an input power overload at any of the three receiver inputs, and automatically reduce the output power of the source to -85 dBm. This is indicated with the message "OVERLOAD ON INPUT (R, A, B)." In addition, the annotation "P↓" appears at the left side of the display. When this occurs, set the power to a lower level, and toggle **SOURCE PWR** on **OFF**. If power meter cal is on, cal power is the active entry.

POWER: FIXED

sets the external LO fixed power.

POWER: SWEEP

sets the external LO power sweep.

POWER LOSS

brings up the segment modify menu and segment edit (power loss) menu explained in the following pages. This softkey is intended for use when the power output is being sampled by a directional coupler or power splitter. In the case of the directional coupler, enter the power loss caused by the coupled arm. Refer to Power Loss Feature on a previous page.

This feature may be used to compensate for attenuation non-linearities in either a directional coupler or a power splitter. Up to 12 segments may be entered, each with a different frequency and power loss value.

POWER MTR

toggles between **436A** or **438A/437**. These power meters are HP-IB compatible with the analyzer. The model number in the softkey label must match the power meter to be used.

POWER SWEEP

turns on a power sweep mode that is used to characterize power-sensitive circuits. In this mode, power is swept at a single frequency, from a start power value to a stop power value, selected using the **(START)** and **(STOP)** keys and the entry block. This feature is convenient for such measurements as gain compression or AGC (automatic gain control) slope. To set the frequency of the power sweep, use **CW FREQ** in the stimulus menu. Refer to the User's Guide for an example of a gain compression measurement.

Note that power range switching is not allowed in power sweep mode.

<u>PRESET</u>	In power sweep, the entered sweep time may be automatically changed if it is less than the minimum required for the current configuration (number of points, IF bandwidth, averaging, etc.).
<u>PRESET: FACTORY</u>	presents a menu to select a factory or user defined preset state.
<u>PRESET: USER</u>	is used to select the preset conditions defined by the factory.
<u>PREVIOUS PAGE</u>	is used to select a preset condition defined by the user. This is done by saving a state in a register under <u>SAVE/RECALL</u> and naming the register UPRESET. When <u>PRESET: USER</u> is underlined, the <u>PRESET</u> key will bring up the state of the UPRESET register.
<u>PRINT ALL COLOR</u>	steps backward through a tabular list of data page-by-page.
<u>PRINT ALL MONOCHROME</u>	when displaying list values, prints the entire list in color. When displaying operating parameters, prints all but the last page in color. The data is sent to the printer as ASCII text rather than as raster graphics, which causes the printout to be faster.
<u>PRINT: COLOR</u>	when displaying list values, prints the entire list in monochrome. When displaying operating parameters, prints all but the last page in monochrome. The data is sent to the printer as ASCII text rather than as raster graphics, which causes the printout to be faster.
<u>PRINT COLOR</u>	sets the print command to default to a color printer. The printer output is always in the analyzer default color values. This command does not work with a black and white printer.
<u>PRINT COLORS</u>	prints the displayed measurement results in color.
<u>PRINT: MONOCHROME</u>	is used to select the print colors menu.
<u>PRINT MONOCHROME</u>	sets the print command to default to a black and white printer.
<u>PRINT SEQUENCE</u>	prints the displayed measurement results in black and white.
<u>PRINTER BAUD RATE</u>	prints any sequence currently in memory to a compatible printer.
<u>PRINTER FORM FEED</u>	sets the serial port data transmission speed for prints.
<u>PRINTER PORT</u>	sends a conditional form feed to the printer.
<u>PRNTR TYPE [DESKJET]</u>	sets the HP-IB address the analyzer will use to communicate with the printer.
<u>PRNTR TYPE [EPSON-P2]</u>	sets the printer type to the DeskJet series.
<u>PRNTR TYPE [LASERJET]</u>	sets the printer type to Epson compatible printers, which support the Epson ESC/P2 printer control language.
<u>PRNTR TYPE [PAINTJET]</u>	sets the printer type to the LaserJet series.
<u>PRNTR TYPE [THINKJET]</u>	sets the printer type to the PaintJet.
<u>PWR LOSS on OFF</u>	sets the printer type to the ThinkJet or QuietJet.
	turns on or off power loss correction. Power loss correction should be used when the power output is measured by a

	directional coupler. Enter the power loss caused by the coupled arm with the <code>LOSS/SENSR LISTS</code> softkey submenus described below.
<code>PWR RANGE AUTO man</code>	toggles the power range mode between auto and manual. Auto mode selects the power range based on the power selected. Manual mode limits power entry to within the selected range.
<code>PWRMTR CAL []</code>	leads to the power meter calibration menu which provides two types of power meter calibration, continuous and single-sample.
<code>PWRMTR CAL [OFF]</code>	turns off power meter calibration.
<code>R</code>	measures the absolute power amplitude at input R.
<code>R+jX MKR</code>	converts the active marker values into rectangular form. The complex impedance values of the active marker are displayed in terms of resistance, reactance, and equivalent capacitance or inductance. This is the default Smith chart marker.
<code>RANGE 0 -15 TO +10</code>	selects power range 0 when in manual power range.
<code>RANGE 1 -25 TO 0</code>	selects power range 1 when in manual power range.
<code>RANGE 2 -35 TO -10</code>	selects power range 2 when in manual power range.
<code>RANGE 3 -45 TO -20</code>	selects power range 3 when in manual power range.
<code>RANGE 4 -55 TO -30</code>	selects power range 4 when in manual power range.
<code>RANGE 5 -65 TO -40</code>	selects power range 5 when in manual power range.
<code>RANGE 6 -75 TO -50</code>	selects power range 6 when in manual power range.
<code>RANGE 7 -85 TO -60</code>	selects power range 7 when in manual power range.
<code>RAW ARRAY on OFF</code>	specifies whether or not to store the raw data (ratioed and averaged) on disk with the instrument state.
<code>RAW OFFSET On Off</code>	selects whether sampler and attenuator offsets are ON or OFF. By selecting raw offsets OFF, a full two port error correction can be performed without including the effects of the offsets. It also saves substantial time at recalls and during frequency changes. Raw offsets follow the channel coupling. This softkey is used with "Take4" mode. See "Example 2E" in Chapter 2 of the <i>HP 8753D Programmer's Guide</i> .
<code>Re/Im MKR</code>	when in the smith marker menu, <code>Re/Im MKR</code> displays the values of the active marker on a Smith chart as a real and imaginary pair. The complex data is separated into its real part and imaginary part. The first marker value given is the real part $M \cos \theta$, and the second value is the imaginary part $M \sin \theta$, where M = magnitude. When in the polar marker menu, <code>Re/Im MKR</code> displays the values of the active marker as a real and imaginary pair. The complex data is separated into its real part and imaginary part. The first marker value given is the real part $M \cos \theta$, and the second value is the imaginary part $M \sin \theta$, where M = magnitude.

<code>READ FILE TITLES</code>	searches the directory of the disk for file names recognized as belonging to an instrument state, and displays them in the softkey labels. No more than five titles are displayed at one time. If there are more than five, repeatedly pressing this key causes the next five to be displayed. If there are fewer than five, the remaining softkey labels are blanked.
<code>READ SEQ FILE TITLS</code>	is a disk file directory command. Pressing this softkey will read the first six sequence titles and display them in the softkey labels as described in Loading a Sequence When the Title Is Not Known. These sequences can then be loaded into internal memory. If <code>READ SEQ FILE TITLS</code> is pressed again, the next six sequence titles on the disk will be displayed. To read the contents of the disk starting again with the first sequence: remove the disk, reinsert it into the drive, and press <code>READ SEQ FILE TITLS</code> .
<code>REAL</code>	displays only the real (resistive) portion of the measured data on a Cartesian format. This is similar to the linear magnitude format, but can show both positive and negative values. It is primarily used for analyzing responses in the time domain, and also to display an auxiliary input voltage signal for service purposes.
<code>RECALL CAL PORT 1</code>	Press this key after selecting the file associated with port 1 error correction for adapter removal calibration.
<code>RECALL CAL PORT 2</code>	Press this key after selecting the file associated with port 2 error correction for adapter removal calibration.
<code>RECALL COLORS</code>	recalls the previously saved modified version of the color set. This key appears only when a color set has been saved.
<code>RECALL KEYS MENU</code>	provides access to the recall keys menu where specific registers can be recalled.
<code>RECALL KEYS on OFF</code>	presents the recall keys menu as the initial menu when <code>(SAVE/RECALL)</code> has been pressed.
<code>RECALL REG1</code>	recalls the instrument state saved in register 1.
<code>RECALL REG2</code>	recalls the instrument state saved in register 2.
<code>RECALL REG3</code>	recalls the instrument state saved in register 3.
<code>RECALL REG4</code>	recalls the instrument state saved in register 4.
<code>RECALL REG5</code>	recalls the instrument state saved in register 5.
<code>RECALL REG6</code>	recalls the instrument state saved in register 6.
<code>RECALL REG7</code>	recalls the instrument state saved in register 7.
<code>RECALL STATE</code>	is used in conjunction with sequencing, to return the instrument to the known preset state without turning off the sequencing function. This is not the same as pressing the <code>(PRESET)</code> key: no preset tests are run, and the HP-IB and sequencing activities are not changed.

RECEIVER CAL

provides access to the Receiver Cal Menu.

REFERENCE POSITION

sets the position of the reference line on the graticule of a Cartesian display, with 0 the bottom line of the graticule and 10 the top line. It has no effect on a polar or Smith display. The reference position is indicated with a small triangle just outside the graticule, on the left side for channel 1 and the right side for channel 2.

REFERENCE VALUE

changes the value of the reference line, moving the measurement trace correspondingly. In polar and Smith chart formats, the reference value is the same as the scale, and is the value of the outer circle.

REFL: FWD S11 (A/R)

defines the measurement as S_{11} , the complex reflection coefficient (magnitude and phase) of the test device input.

REFL: REV S22 (B/R)

defines the measurement as S_{22} , the complex reflection coefficient (magnitude and phase) of the output of the device under test.

REFLECT AND LINE

measures the reflection and thru paths of the current calibration standard.

REFLECTION

leads to the reflection calibration menu.

REMOVE ADAPTER

completes the adapter removal procedure, removing the effects of the adapter being used.

RENAME FILE

allows you to change the name of a file that has already been saved.

RESET COLOR

resets the color being modified to the default color.

RESPONSE

- When in the specify class more menu, **RESPONSE** is used to enter the standard numbers for a response calibration. This calibration corrects for frequency response in either reflection or transmission measurements, depending on the parameter being measured when a calibration is performed. (For default kits, the standard is either the open or short for reflection measurements, or the thru for transmission measurements.)
- When in the response cal menu, **RESPONSE** leads to the frequency response calibration. This is the simplest and fastest accuracy enhancement procedure, but should be used when extreme accuracy is not required. It effectively removes the frequency response errors of the test setup for reflection or transmission measurements.

RESPONSE & ISOL'N

- When in the specify class more menu, **RESPONSE & ISOL'N** is used to enter the standard numbers for a response and isolation calibration. This calibration corrects for frequency response and directivity in reflection measurements, or frequency response and isolation in transmission measurements.
- When in the response and isolation menu, **RESPONSE & ISOL'N** leads to the menus used to perform a response and isolation measurement calibration, for measurement of devices with wide dynamic range. This

procedure effectively removes the same frequency response errors as the response calibration. In addition, it effectively removes the isolation (crosstalk) error in transmission measurements or the directivity error in reflection measurements. As well as the devices required for a simple response calibration, an isolation standard is required. The standard normally used to correct for isolation is an impedance-matched load (usually 50 or 75 ohms). Response and directivity calibration procedures for reflection and transmission measurements are provided in the following pages.

RESTORE DISPLAY	turns off the tabular listing and returns the measurement display to the screen.
RESUME CAL SEQUENCE	eliminates the need to restart a calibration sequence that was interrupted to access some other menu. This softkey goes back to the point where the calibration sequence was interrupted.
REV ISOL'N ISOL'N STD	measures the reverse isolation of the calibration standard.
REV MATCH (Label Class)	lets you enter a label for the reverse match class. The label appears during a calibration that uses this class.
REV MATCH (Specify Class)	specifies which standards are in the reverse match class in the calibration kit.
REV MATCH THRU	is used to enter the standard numbers for the reverse match (thru) calibration. (For default kits, this is the thru.)
REV TRANS (Label Class)	lets you enter a label for the reverse transmission class. The label appears during a calibration that uses this class.
REV TRANS (Specify Class)	specifies which standards are in the reverse transmission class in the calibration kit.
REV TRANS THRU	is used to enter the standard numbers for the reverse transmission (thru) calibration. (For default kits, this is the thru.)
RF > LO	adjusts the source frequency higher than the LO by the amount of the LO (within the limits of the analyzer).
RF < LO	adjusts the source frequency lower than the LO by the amount of the LO (within the limits of the analyzer).
RIGHT LOWER	draws a quarter-page plot in the lower right quadrant of the page.
RIGHT UPPER	draws a quarter-page plot in the upper right quadrant of the page.
ROUND SECONDS	resets the seconds counter to zero in real-time clock.
S PARAMETERS	presents the S-parameter menu, which is used to define the input ports and test set direction for S-parameter measurements.
S11 1-PORT	provides a measurement calibration for reflection-only measurements of one-port devices or properly terminated two-port devices, at port 1 of an S-parameter test set or the test port of a transmission/reflection test set.

S11A	is used to enter the standard numbers for the first class required for an S_{11} 1-port calibration. (For default cal kits, this is the open.)
S11B	is used to enter the standard numbers for the second class required for an S_{11} 1-port calibration. (For default cal kits, this is the short.)
S11C	is used to enter the standard numbers for the third class required for an S_{11} 1-port calibration. (For default kits, this is the load.)
S11 REFL SHORT	measures the short circuit TRL/LRM calibration data for PORT 1.
S22 1-PORT	provides a measurement calibration for reflection-only measurements of one-port devices or properly terminated two-port devices, at port 2 of an S-parameter test set or the test port of a transmission/reflection test set.
S22A	is used to enter the standard numbers for the first class required for an S_{22} 1-port calibration. (For default cal kits, this is the open.)
S22B	is used to enter the standard numbers for the second class required for an S_{22} 1-port calibration. (For default cal kits, this is the short.)
S22C	is used to enter the standard numbers for the third class required for an S_{22} 1-port calibration. (For default kits, this is the load.)
S22 REFL SHORT	measures the short circuit TRL/LRM calibration data for PORT 2.
SAMPLR COR on OFF	selects whether sampler correction is on or off.
SAVE COLORS	saves the modified version of the color set.
SAVE/RECALL	provides access to all the menus used for saving and recalling instrument states in internal memory and for storing to, or loading from, external disk. This includes the menus used to define titles for internal registers and external disk files, to define the content of disk files, to initialize disks for storage, and to clear data from the registers or purge files from disk.
SAVE USER KIT	stores the user-modified or user-defined kit into memory, after it has been modified.
SAVE USING ASCII	selects ASCII format for data storage to disk.
SAVE USING BINARY	selects binary format for data storage.
SCALE/DIV	changes the response value scale per division of the displayed trace. In polar and Smith chart formats, this refers to the full scale value at the outer circumference, and is identical to reference value.
SCALE PLOT []	toggles between two selections for plot scale, FULL and GRAT.
SCALE PLOT [FULL]	is the normal scale selection for plotting on blank paper. It includes space for all display annotations such as marker values, stimulus values, etc. The entire display fits within the

	user-defined boundaries of P1 and P2 on the plotter, while maintaining the exact same aspect ratio as the display.
SCALE PLOT [GRAT]	expands or reduces the horizontal and vertical scale so that the lower left and upper right graticule corners exactly correspond to the user-defined P1 and P2 scaling points on the plotter. This is convenient for plotting on preprinted rectangular or polar forms (for example, on a Smith Chart).
SCALE REF]	makes scale per division the active function. A menu is displayed that is used to modify the vertical axis scale and the reference line value and position. In addition this menu provides electrical delay offset capabilities for adding or subtracting linear phase to maintain phase linearity.
SEARCH LEFT	searches the trace for the next occurrence of the target value to the left.
SEARCH RIGHT	searches the trace for the next occurrence of the target value to the right.
SEARCH: MAX	moves the active marker to the maximum point on the trace.
SEARCH: MIN	moves the active marker to the minimum point on the trace.
SEARCH: OFF	turns off the marker search function.
SEGMENT	specifies which limit segment in the table is to be modified. A maximum of three sets of segment values are displayed at one time, and the list can be scrolled up or down to show other segment entries. Use the entry block controls to move the pointer > to the required segment number. The indicated segment can then be edited or deleted. If the table of limits is designated "EMPTY," new segments can be added using the ADD or EDIT softkey.
SEGMENT: CENTER	sets the center frequency of a subsweep in a list frequency sweep.
SEGMENT: SPAN	sets the frequency or power span of a subsweep about a specified center frequency.
SEGMENT: START	sets the start frequency of a subsweep.
SEGMENT: STOP	sets the stop frequency of a subsweep.
SEL QUAD	leads to the select quadrant menu, which provides the capability of drawing quarter-page plots. This is not used for printing.
SELECT DISK	provides access to the select disk menu.
SELECT LETTER	The active entry area displays the letters of the alphabet, digits 0 through 9, and mathematical symbols. To define a title, rotate the knob until the arrow ↑ points at the first letter, then press SELECT LETTER. Repeat this until the complete title is defined, for a maximum of 50 characters. As each character is selected, it is appended to the title at the top of the graticule.
SELF DIAGNOSE	prompts the analyzer to run a series of tests to determine a problem.

SEQ

SEQUENCE 1 SEQ1

accesses a series of sequencing menus. These allow you to create, modify, and store up to 6 sequences which can be run automatically.

activates editing mode for the segment titled "SEQ1" (default title).

SEQUENCE 2 SEQ2

activates editing mode for the segment titled "SEQ2" (default title).

SEQUENCE 3 SEQ3

activates editing mode for the segment titled "SEQ3" (default title).

SEQUENCE 4 SEQ4

activates editing mode for the segment titled "SEQ4" (default title).

SEQUENCE 5 SEQ5

activates editing mode for the segment titled "SEQ5" (default title).

SEQUENCE 6 SEQ6

activates editing mode for the segment titled "SEQ6" (default title).

SEQUENCE FILENAMING

accesses a filenaming menu which is used to automatically increment or decrement the name of a file that is generated by the network analyzer during a SEQUENCE.

SERVICE MENU

leads to a series of service and test menus described in detail in the *On-Site System Service Manual*.

SERVICE MODES

a collection of common modes used for troubleshooting.

SET ADDRESSES

goes to the address menu, which is used to set the HP-IB address of the analyzer, and to display and modify the addresses of peripheral devices in the system.

SET CLOCK

allows you to set the analyzer's internal clock.

SET DAY

allows you to set the day in the analyzer's internal clock.

SET FREQ LOW PASS

(Option 010 only) changes the frequency sweep to harmonic intervals to accommodate time domain low-pass operation (option 010). If this mode is used, the frequencies must be set before calibration.

SET HOUR

allows you to set the hour in the analyzer's internal clock.

SET MINUTES

allows you to set the minutes in the analyzer's internal clock.

SET MONTH

allows you to set the month in the analyzer's internal clock.

SET REF: REFLECT

sets the measurement reference plane to the TRL/LRM REFLECT standard.

SET REF: THRU

sets the measurement reference plane to the TRL/LRM THRU standard.

SET YEAR

allows you to set the year in the analyzer's internal clock.

SET Z0

sets the characteristic impedance used by the analyzer in calculating measured impedance with Smith chart markers and conversion parameters. Characteristic impedance must be set correctly before calibration procedures are performed.

SHORT	defines the standard type as a short, for calibrating reflection measurements. Shorts are assigned a terminal impedance of 0 ohms, but delay and loss offsets may still be added.
SHOW MENUS	used to display a specific menu prior to a pause statement.
SINGLE	takes one sweep of data and returns to the hold mode.
SINGLE POINT	sets the limits at a single stimulus point. If limit lines are on, the upper limit value of a single point limit is displayed as \9, and the lower limit is displayed as \8. A limit test at a single point not terminating a flat or sloped line tests the nearest actual measured data point. A single point limit can be used as a termination for a flat line or sloping line limit segment. When a single point terminates a sloping line or when it terminates a flat line and has the same limit values as the flat line, the single point is not displayed as \9 and \8. The indication for a sloping line segment in the displayed table of limits is SP.
SINGLE SEG SWEEP	enables a measurement of a single segment of the frequency list, without loss of calibration. The segment to be measured is selected using the entry block. In single segment mode, selecting a measurement calibration will force the full list sweep before prompting for calibration standards. The calibration will then be valid for any single segment. If an instrument state is saved in memory with a single-segment trace, a recall will re-display that segment while also recalling the entire list.
SLIDING	defines the load as a sliding load. When such a load is measured during calibration, the analyzer will prompt for several load positions, and calculate the ideal load value from it.
SLOPE	compensates for power loss versus the frequency sweep, by sloping the output power upwards proportionally to frequency. Use this softkey to enter the power slope in dB per GHz of sweep.
SLOPE on OFF	toggles the power slope function on or off. With slope on, the output power increases with frequency, starting at the selected power level.
SLOPING LINE	defines a sloping limit line segment that is linear with frequency or other stimulus value, and is continuous to the next stimulus value and limit. If a sloping line is the final segment it becomes a flat line terminated at the stop stimulus. A sloping line segment is indicated as SL on the displayed table of limits.
SMITH CHART	displays a Smith chart format. This is used in reflection measurements to provide a readout of the data in terms of impedance.
SMITH MKR MENU	leads to a menu of special markers for use with a Smith chart format.
SMOOTHING APERTURE	lets you change the value of the smoothing aperture as a percent of the span. When smoothing aperture is the active

	function, its value in stimulus units is displayed below its percent value in the active entry area.
	Smoothing aperture is also used to set the aperture for group delay measurements. Note that the displayed smoothing aperture is not the group delay aperture unless smoothing is on.
SMOOTHING on OFF	turns the smoothing function on or off for the active channel. When smoothing is on, the annotation “Smo” is displayed in the status notations area.
SOURCE PWR on OFF	turns the source power on or off. Use this key to restore power after a power trip has occurred. (See the POWER key description.)
SPACE	inserts a space in the title.
(SPAN)	is used, along with the (CENTER) key, to define the frequency range of the stimulus. When the (SPAN) key is pressed it becomes the active function. The value is displayed in the active entry area, and can be changed with the knob, step keys, or numeric keypad.
SPAN	sets the frequency or power span of a subsweep about a specified center frequency.
SPECIAL FUNCTIONS	presents the special function menu.
SPECIFY CLASS	leads to the specify class menu. After the standards are modified, use this key to specify a class to consist of certain standards.
SPECIFY CLASS DONE	finishes the specify class function and returns to the modify cal kit menu.
SPECIFY GATE	(Option 010 only) is used to specify the parameters of the gate.
SPECIFY OFFSET	allows additional specifications for a user-defined standard. Features specified in this menu are common to all five types of standards.
SPLIT DISP on OFF	toggles between a full-screen single graticule display of one or both channels, and a split display with two half-screen graticules one above the other. The split display can be used in conjunction with DUAL CH ON in the display menu to show the measured data of each channel simultaneously on separate graticules. In addition, the stimulus functions of the two channels can be controlled independently using COUPLED CH ON in the stimulus menu. The markers can also be controlled independently for each channel using MARKERS: UNCOUPLED in the marker mode menu.
SPUR AVOID On Off	selects whether spur avoidance is ON or OFF. Selecting spur avoidance OFF, along with selecting raw offsets OFF, saves substantial time at recalls and during frequency changes. Spur avoidance is always coupled between channels.
(START)	is used to define the start frequency of a frequency range. When the (START) key is pressed it becomes the active function.

STATS on OFF	The value is displayed in the active entry area, and can be changed with the knob, step keys, or numeric keypad.
STD DONE (DEFINED)	calculates and displays the mean, standard deviation, and peak-to-peak values of the section of the displayed trace between the active marker and the delta reference marker. If there is no delta reference, the statistics are calculated for the entire trace. A convenient use of this feature is to find the peak-to-peak value of passband ripple without searching separately for the maximum and minimum values.
STD OFFSET DONE	The statistics are absolute values: the delta marker here serves to define the span. For polar and Smith chart formats the statistics are calculated using the first value of the complex pair (magnitude, real part, resistance, or conductance).
STD TYPE:	After each standard is defined, including offsets, press STD DONE (DEFINED) to terminate the standard definition.
STD TYPE: ARBITRARY IMPEDANCE	returns to the define standard menu. is used to end the specify offset sequence. is used to specify the type of calibration device being measured. defines the standard type to be a load, but with an arbitrary impedance (different from system Z ₀).
STD TYPE: DELAY/THRU	defines the standard type as a transmission line of specified length, for calibrating transmission measurements.
STD TYPE: LOAD	defines the standard type as a load (termination). Loads are assigned a terminal impedance equal to the system characteristic impedance Z ₀ , but delay and loss offsets may still be added. If the load impedance is not Z ₀ , use the arbitrary impedance standard definition.
STD TYPE: OPEN	defines the standard type as an open used for calibrating reflection measurements. Opens are assigned a terminal impedance of infinite ohms, but delay and loss offsets may still be added. Pressing this key also brings up a menu for defining the open, including its capacitance.
STD TYPE: SHORT	defines the standard type as a short used for calibrating reflection measurements. Shorts are assigned a terminal impedance of 0 ohms, but delay and loss offsets may still be added.
STEP SIZE	is used to specify the subsweep in frequency steps instead of number of points. Changing the start frequency, stop frequency, span, or number of points may change the step size. Changing the step size may change the number of points and stop frequency in start/stop/step mode; or the frequency span in center/span/step mode. In each case, the frequency span becomes a multiple of the step size.
STIMULUS VALUE	sets the starting stimulus value of a segment, using entry block controls. The ending stimulus value of the segment is defined by the start of the next line segment. No more than one segment can be defined over the same stimulus range.

STIMULUS OFFSET

adds or subtracts an offset in stimulus value. This allows limits already defined to be used for testing in a different stimulus range. Use the entry block controls to specify the offset required.

STOP

is used to define the stop frequency of a frequency range. When the **STOP** key is pressed it becomes the active function. The value is displayed in the active entry area, and can be changed with the knob, step keys, or numeric keypad.

STOP

sets the stop frequency of a subsweep.

STORE SEQ TO DISK

presents the store sequence to disk menu with a list of sequences that can be stored.

SWEEP

is used to set the frequency of the LO source to sweep.

SWEEP TIME []

toggles between automatic and manual sweep time.

SWEEP TYPE MENU

presents the sweep type menu, where one of the available types of stimulus sweep can be selected.

SWR

reformats a reflection measurement into its equivalent SWR (standing wave ratio) value. SWR is equivalent to $(1+\rho)/(1-\rho)$, where ρ is the reflection coefficient. Note that the results are valid only for reflection measurements. If the SWR format is used for measurements of S_{21} or S_{12} the results are not valid.

SYSTEM

presents the system menu.

SYSTEM CONTROLLER

is the mode used when peripheral devices are to be used and there is no external controller. In this mode, the analyzer can directly control peripherals (plotter, printer, disk drive, or power meter). System controller mode must be set in order for the analyzer to access peripherals from the front panel to plot, print, store on disk, or perform power meter functions, if there is no other controller on the bus.

The system controller mode can be used without knowledge of HP-IB programming. However, the HP-IB address must be entered for each peripheral device.

This mode can only be selected manually from the analyzer's front panel, and can be used only if no active computer controller is connected to the system through HP-IB. If you try to set system controller mode when another controller is present, the message **ANOTHER SYSTEM CONTROLLER ON HP-IB BUS** is displayed. Do not attempt to use this mode for programming.

TAKE CAL SWEEP

Each data point is measured during the initial sweep and the correction data is placed in the power meter correction table. This provides data usable in the **ONE SWEEP** mode.

TAKE RCVR CAL SWEEP

executes a receiver calibration.

TALKER/LISTENER

is the mode normally used for remote programming of the analyzer. In this mode, the analyzer and all peripheral devices are controlled from the external controller. The controller can command the analyzer to talk, and the plotter or other device to listen. The analyzer and peripheral devices cannot talk

directly to each other unless the computer sets up a data path between them.

This mode allows the analyzer to be either a talker or a listener, as required by the controlling computer for the particular operation in progress.

A talker is a device capable of sending out data when it is addressed to talk. There can be only one talker at any given time. The analyzer is a talker when it sends information over the bus.

A listener is a device capable of receiving data when it is addressed to listen. There can be any number of listeners at any given time. The analyzer is a listener when it is controlled over the bus by a computer.

TARGET

makes target value the active function, and places the active marker at a specified target point on the trace. The default target value is -3 dB. The target menu is presented, providing search right and search left options to resolve multiple solutions.

For relative measurements, a search reference must be defined with a delta marker or a fixed marker before the search is activated.

TERMINAL IMPEDANCE

is used to specify the (arbitrary) impedance of the standard, in ohms.

TEST OPTIONS

is used to set configurations before running the service tests.

TESTPORT 1 2

is used to direct the RF power to port 1 or port 2. (For non-S parameter inputs only.)

TESTSET I/O FWD

is used to support specialized test sets, such as a testset that measures duplexers. It allows you to set three bits (D1, D2, and D3) to a value of 0 to 7, and outputs it as binary from the rear panel testset connector. It tracks the coupling flag, so if coupling is on, and FWD channel 1 is the active channel, FWD channel 2 will be set to the same value.

TESTSET I/O REV

is used to support specialized testsets, such as a testset that measures duplexers. It allows you to set three bits (D1, D2, and D3) to a value of 0 to 7, and outputs it as binary from the rear panel testset connector. It tracks the coupling flag, so if coupling is on, and REV channel 1 is the active channel, REV channel 2 will be set to the same value.

TESTSET SW XXXX

toggles the internal solid state switch from a hold mode, to a continuously switching mode, or to a number of sweeps mode when full 2-port correction is enabled. Use for fast 2-port calibration.

TESTS

presents the service test menu.

TEXT

selects all the non-data text for color modification. For example: operating parameters.

TEXT []

brings up the color definition menu. The default color for text is black.

<code>THRU</code>	a calibration standard type.
<code>THRU THRU</code>	measures all four S-parameters in a TRL/LRM calibration.
<code>TIME STAMP on OFF</code>	turns the time stamp function on or off.
<code>TINT</code>	adjusts the continuum of hues on the color wheel of the chosen attribute. See Adjusting Color for an explanation of using this softkey for color modification of display attributes.
<code>TITLE</code>	presents the title menu in the softkey labels area and the character set in the active entry area. These are used to label the active channel display. A title more menu allows up to four values to be included in the printed title; active entry, active marker amplitude, limit test results, and loop counter value.
<code>TITLE SEQUENCE</code>	allows the operator to rename any sequence with an eight character title. All titles entered from the front panel must begin with a letter, and may only contain letters and numbers. A procedure for changing the title of a sequence is provided at the beginning of this chapter.
<code>TITLE TO MEMORY</code>	<p>moves the title string data obtained with the <code>P MTR/HPIB TO TITLE</code> command into a data array.</p> <p><code>TITLE TO MEMORY</code> strips off leading characters that are not numeric, reads the numeric value, and then discards everything else. The number is converted into analyzer internal format, and is placed into the real portion of the memory trace at:</p> $\text{Display point} = \text{total points} - 1 - \text{loop counter}$ <p>If the value of the loop counter is zero, then the title number goes in the last point of memory. If the loop counter is greater than or equal to the current number of measurement points, the number is placed in the first point of memory. A data to memory command must be executed before using the title to memory command.</p>
<code>TITLE TO P MTR/HPIB</code>	<p>outputs a title string to any device with an HP-IB address that matches the address set with the analyzer <code>(LOCAL) SET ADDRESSES ADDRESS: P MTR/HPIB</code> commands. This softkey is generally used for two purposes:</p> <ul style="list-style-type: none"> ■ Sending a title to a printer when a CR-LF is not desired. ■ Sending commands to an HP-IB device.
<code>TITLE TO PERIPHERAL</code>	<p>outputs a title string to any device with an HP-IB address that matches the address set with the analyzer <code>(SEQ) SPECIAL FUNCTIONS PERIPHERAL HPIB ADDR</code> commands. This softkey is generally used for two purposes:</p> <ul style="list-style-type: none"> ■ Sending a title to a printer when a CR-LF is not desired. ■ Sending commands to an HP-IB device.
<code>TITLE TO PRNTR/HPIB</code>	<p>outputs a title string to any device with an HP-IB address that matches the address set with the analyzer <code>(LOCAL) SET ADDRESSES ADDRESS: PRINTER</code> commands. This softkey is generally used for two purposes:</p>

	<ul style="list-style-type: none"> ■ Sending a title to a printer for data logging or documentation purposes. ■ Sending commands to a printer or other HP-IB device.
TRACKING on OFF	is used in conjunction with other search features to track the search with each new sweep. Turning tracking on makes the analyzer search every new trace for the specified target value and put the active marker on that point. If bandwidth search is on, tracking searches every new trace for the specified bandwidth, and repositions the dedicated bandwidth markers. When tracking is off, the target is found on the current sweep and remains at the same stimulus value regardless of changes in trace response value with subsequent sweeps. A maximum and a minimum point can be tracked simultaneously using two channels and uncoupled markers.
TRANS DONE	goes back to the two-port cal menu when transmission measurements are finished.
TRANS: FWD S21 (B/R)	defines the measurement as S_{21} , the complex forward transmission coefficient (magnitude and phase) of the test device.
TRANS: REV S12 (A/R)	defines the measurement as S_{12} , the complex reverse transmission coefficient (magnitude and phase) of the test device.
TRANSFORM MENU	(Option 010 only) leads to a series of menus that transform the measured data from the frequency domain to the time domain.
TRANSFORM on OFF	(Option 010 only) switches between time domain transform on and off.
TRANSMISSION	leads to the transmission menu.
TRIGGER MENU	presents the trigger menu, which is used to select the type and number of the sweep trigger.
TRIGGER: TRIG OFF	turns off external trigger mode.
TRL*/LRM* 2-PORT	leads to the TRL*/LRM* 2-port calibration menu.
TRL/LRM OPTION	selects the TRL/LRM Option Menu.
TRL LINE OR MATCH	is used to enter the standard numbers for the TRL LINE or MATCH class.
TRL THRU	is used to enter the standard numbers for the TRL THRU class.
TRL REFLECT	is used to enter the standard numbers for the TRL REFLECT class.
TTL OUT HIGH	sets the TTL output (TEST SEQ BNC) on the back of the analyzer high.
TTL OUT LOW	sets the TTL output (TEST SEQ BNC) on the back of the analyzer low.
TUNED RECEIVER	sets the analyzer to function as a tuned receiver only, disabling the source.

UNCOUPLED

allows the marker stimulus values to be controlled independently on each channel.

UP CONVERTER

sends the sum frequency of the RF and LO to the R channel.

UPPER LIMIT

sets the upper limit value for the start of the segment. If a lower limit is specified, an upper limit must also be defined. If no upper limit is required for a particular measurement, force the upper limit value out of range (for example +500 dB).

When **UPPER LIMIT** or **LOWER LIMIT** is pressed, all the segments in the table are displayed in terms of upper and lower limits, even if they were defined as delta limits and middle value.

If you attempt to set an upper limit that is lower than the lower limit, or vice versa, both limits will be automatically set to the same value.

USE MEMORY ON off

(Option 010 only) remembers a specified window pulse width (or step rise time) different from the standard window values. A window is activated only for viewing a time domain response, and does not affect a displayed frequency domain response.

USE PASS CONTROL

lets you control the analyzer with the computer over HP-IB as with the talker/listener mode, and also allows the analyzer to become a controller in order to plot, print, or directly access an external disk. During this peripheral operation, the host computer is free to perform other internal tasks that do not require use of the bus (the bus is tied up by the network analyzer during this time).

The pass control mode requires that the external controller is programmed to respond to a request for control and to issue a take control command. When the peripheral operation is complete, the analyzer passes control back to the computer. Refer to the "HP-IB Programming Reference" and "HP-IB Programming Examples" chapters in the *HP 8753D Network Analyzer Programmer's Guide* for more information.

In general, use the talker/listener mode for programming the analyzer unless direct peripheral access is required.

USE SENSOR A/B

selects the A or B power sensor calibration factor list for use in power meter calibration measurements.

USER

is used to select the preset condition defined by the user.

USER KIT

is used to define kits other than those offered by Hewlett-Packard.

VELOCITY FACTOR

Enters the velocity factor used by the analyzer to calculate equivalent electrical length in distance-to-fault measurements using the time domain option. Values entered should be less than 1.

Velocity factor is the ratio of the velocity of wave propagation in a coaxial cable to the velocity of wave propagation in free space. Most cables have a relative velocity of about 0.66 the

speed in free space. This velocity depends on the relative permittivity of the cable dielectric (ϵ_r) as

$$VelocityFactor = \frac{1}{\sqrt{\epsilon_r}}$$

VIEW MEASURE

toggles to become view setup when the analyzer is in frequency offset mode.

VOLUME NUMBER

specifies the number of the disk volume to be accessed. In general, all 3.5 inch floppy disks are considered one volume (volume 0). For hard disk drives, such as the HP 9153A (Winchester), a switch in the disk drive must be set to define the number of volumes on the disk. For more information, refer to the manual for the individual hard disk drive.

WAIT x

pauses the execution of subsequent sequence commands for x number of seconds. Terminate this command with **[x1]**.

Entering a 0 in wait x causes the instrument to wait for prior sequence command activities to finish before allowing the next command to begin. The wait 0 command only affects the command immediately following it, and does not affect commands later in the sequence.

WARNING

selects the warning annotation for color modification.

WARNING []

brings up the color definition menu. The warning annotation default color is black.

WAVEGUIDE

defines the standard (and the offset) as rectangular waveguide. This causes the analyzer to assume a dispersive delay (see **OFFSET DELAY** above).

WAVEGUIDE DELAY

applies a non-linear phase shift for use with electrical delay which follows the standard dispersive phase equation for rectangular waveguide. When **WAVEGUIDE DELAY** is pressed, the active function becomes the **WAVEGUIDE CUTOFF** frequency, which is used in the phase equation. Choosing a Start frequency less than the Cutoff frequency results in phase errors.

WIDTH VALUE

is used to set the amplitude parameter (for example 3 dB) that defines the start and stop points for a bandwidth search. The bandwidth search feature analyzes a bandpass or band reject trace and calculates the center point, bandwidth, and Q (quality factor) for the specified bandwidth. Bandwidth units are the units of the current format.

WIDTHS on OFF

turns on the bandwidth search feature and calculates the center stimulus value, bandwidth, and Q of a bandpass or band reject shape on the trace. The amplitude value that defines the passband or rejectband is set using the **WIDTH VALUE** softkey. Four markers are turned on, and each has a dedicated use. Marker 1 is a starting point from which the search is begun. Marker 2 goes to the bandwidth center point. Marker 3 goes to the bandwidth cutoff point on the left, and Marker 4 to the cutoff point on the right.

If a delta marker or fixed marker is on, it is used as the reference point from which the bandwidth amplitude is measured. For example, if marker 1 is the delta marker and is set at the passband maximum, and the width value is set to -3 dB, the bandwidth search finds the bandwidth cutoff points 3 dB below the maximum and calculates the 3 dB bandwidth and Q.

If marker 2 (the dedicated bandwidth center point marker) is the delta reference marker, the search finds the points 3 dB down from the center.

If no delta reference marker is set, the bandwidth values are absolute values.

WINDOW

(Option 010 only) is used to specify the parameters of the window in the transform menu.

WINDOW: MAXIMUM

(Option 010 only) sets the pulse width to the widest value allowed. This minimizes the sidelobes and provides the greatest dynamic range.

WINDOW: MINIMUM

(Option 010 only) is used to set the window of a time domain measurement to the minimum value. Provides essentially no window.

WINDOW: NORMAL

(Option 010 only) is used to set the window of a time domain measurement to the normal value. Usually the most useful because it reduces the sidelobes of the measurement somewhat.

x1

is used to terminate basic units: dB, dBm, Hz, dB/GHz, degrees, or seconds. It may also be used to terminate unitless entries such as averaging factor.

XMIT CNTRL []

toggles the PLOTTER/PRINTER serial port data transmit control mode between the Xon-Xoff protocol handshake and the DTR-DSR (data terminal ready-data set ready) hardware handshake.

Y: REFL

converts reflection data to its equivalent admittance values.

Y: TRANS

converts transmission data to its equivalent admittance values.

Z: REFL

converts reflection data to its equivalent impedance values.

Z: TRANS

converts transmission data to its equivalent impedance values.

Cross Reference of Key Function to Programming Command

The following table lists the front-panel keys and softkeys alphabetically. The “Command” column identifies the command that is similar to the front-panel or softkey function. Softkeys that do not have corresponding programming commands are not included in this section.

Table 9-1. Cross Reference of Key Function to Programming Command

Key	Name	Command
▲	Step Up	UP
▼	Step Down	DOWN
Δ MODE OFF	Delta Marker Mode Off	DELO
Δ REF = 1	Delta Reference = Marker 1	DELR1
Δ REF = 2	Delta Reference = Marker 2	DELR2
Δ REF = 3	Delta Reference = Marker 3	DELR3
Δ REF = 4	Delta Reference = Marker 4	DELR4
Δ REF = 5	Delta Reference = Marker 5	DELR5
Δ REF = Δ FIXED MKR	Delta Reference = Delta Fixed Marker	DELRFIXM
1/S	Inverted S-Parameters	CONVIDS
A	Measure Channel A	MEASA
A/B	Ratio of A to B	AB
A/R	Ratio of A to R	AR
ADAPTER:COAX	Adapter:Coax	ADPTCOAX
ADAPTER:WAVEGUIDE	Adapter:Waveguide	ADPTWAVE
ADAPTER DELAY	Adapter Delay	ADAP1
ADD	Add	SADD
ADDRESS: CONTROLLER	Address of Controller	ADDRCONT
ADDRESS: DISK	Address of Disk	ADDRDISC
ADDRESS: P MTR/HPIB	Address of Power Meter/HPIB	ADDRPOWM
ALL SEGS SWEEP	All Segments Sweep	ASEG
ALTERNATE A and B	Alternate A and B	ALTAB
AMPLITUDE OFFSET	Amplitude Offset	LIMIAMPO
ANALOG BUS ON off	Analog Bus On	ANAB
ANALOG IN Aux Input	Analog In	ANAI
ARBITRARY IMPEDANCE	Arbitrary Impedance	STDTARBI
ASSERT SRQ	Service Request	ASSS

Table 9-1.
Cross Reference of Key Function to Programming Command (continued)

Key	Name	Command
AUTO FEED ON off (Plotter)	Plotter Auto Feed On	PLTTRAUTFON
AUTO FEED on OFF (Plotter)	Plotter Auto Feed Off	PLTTRAUTFOFF
AUTO FEED ON off (Printer)	Printer Auto Feed On	PRNTRAUTFON
AUTO FEED on OFF (Printer)	Printer Auto Feed Off	PRNTRAUTOFF
AUTO SCALE	Auto Scale	AUTO
AVERAGING FACTOR	Averaging Factor	AVERFACT
AVERAGING ON off	Averaging On	AVERON
AVERAGING on OFF	Averaging Off	AVEROFF
AVERAGING RESTART	Averaging Restart	AVERREST
AVG	Average	MENUAVG
B	Measure Channel B	MEASB
B/R	Ratio of B to R	BR
BACKGROUND INTENSITY	Background Intensity	BACI
BANDPASS	Bandpass	BANDPASS
BEEP DONE ON off	Beep Done On	BEEPDONEON
BEEP DONE on OFF	Beep Done Off	BEEPDONEOFF
BEEP FAIL ON off	Beep Fail On	BEEPFAILON
BEEP FAIL on OFF	Beep Fail Off	BEEPFAILOFF
BEEP WARN ON off	Beep Warn On	BEEPWARNON
BEEP WARN on OFF	Beep Warn Off	BEEPWARNOFF
BLANK DISPLAY	Blank Display On	BLADON
BRIGHTNESS	Brightness	CBRI
C0	C0 Term	C0
C1	C1 Term	C1
C2	C2 Term	C2
C3	C3 Term	C3
CAL	Calibrate	MENUCAL
CAL FACTOR	Calibration Factor	CALFCALF
CAL FACTOR SENSOR A	Calibration Factor Sensor A	CALFSENA
CAL FACTOR SENSOR B	Calibration Factor Sensor B	CALFSENB
CAL KIT: 2.4mm	2.4mm Calibration Kit	CALK24MM
CAL KIT: 2.92*	2.92* Calibration Kit	CALK292S
CAL KIT: 2.92mm	2.92mm Calibration Kit	CALK292MM

Table 9-1.
Cross Reference of Key Function to Programming Command (continued)

Key	Name	Command
CAL KIT: 3.5mmC	3.5mmC Calibration Kit	CALK35MC ¹
CAL KIT: 3.5mmD	3.5mmD Calibration Kit	CALK35MD
CAL KIT: TRL 3.5mm	TRL 3.5mm Calibration Kit	CALKTRLK
CAL KIT: 7mm	7mm Calibration Kit	CALK7MM
CAL KIT: N 50Ω	Type-N 50Ω Calibration Kit	CALKN50
CAL KIT: N 75Ω	Type-N 75Ω Calibration Kit	CALKN75
CAL KIT: USER KIT	User Calibration Kit	CALKUSED
CAL Z0: LINE Z0	line impedance	CALZINE
CAL Z0: SYSTEM Z0	System impedance	CALZSYST
CALIBRATE: NONE	Calibrate None	CALN
CENTER	Center, list freq subsweep	CENT
CHAN 1	Channel 1 Active	CHANT
CH1 DATA []	Channel 1 Data (Color)	PCOLDATA1
CH1 DATA LIMIT LN	Channel 1 Data/Limit Line	COLOCH1D
CH1 MEM	Channel 1 Memory	COLOCH1M
CH1 MEM []	Channel 1 Memory (Color)	PCOLMEMO1
CHAN 2	Channel 2 Active	CH2
CH2 DATA []	Channel 2 Data (Color)	PCOLDATA2
CH2 DATA LIMIT LN	Channel 2 Data/Limit Line	COLOCH2D
CH2 MEM []	Channel 2 Memory (Color)	PCOLMEMO2
CH2 MEM REF LINE	Channel 2 Memory Reference Line	COLOCH2M
CH PWR [COUPLED]	Channel Power Coupled	CHANPCPLD
CH PWR [UNCOUPLD]	Channel Power Uncoupled	CHANPUNCPLD
CHOP A and B	Chop A and B	CHOPAB
CLASS DONE	Class Done	CLAD
CLEAR BIT	Clear Bit	CLEABIT
CLEAR LIST	Clear List	CLEAL
CLEAR SEQUENCE	Clear Sequence	CLEASEn
COAX	Coax	COAX
COAXIAL DELAY	Coaxial Delay	COAD
COLOR	Color	COLOR
CONTINUE SEQUENCE	Continue Sequence	CONS

¹ CALK35MM selects the HP 85053C cal kit for the HP 8752C/53D/53E.

Table 9-1.
Cross Reference of Key Function to Programming Command (continued)

Key	Name	Command
CONTINUOUS	Continuous	CONT
CONVERSION [OFF]	Conversion Off	CONVOFF
COPY	Copy	MENUCOPY
CORRECTION ON off	Correction On	CORRON
CORRECTION on OFF	Correction Off	CORROFF
COUPLED CH ON off	Coupled Channel On	COUCON
COUPLED CH on OFF	Coupled Channel Off	COUCOFF
CW FREQ	CW Frequency	CWFREQ
CW TIME	CW Time	CWTIME
D2/D1 to D2 ON off	Ratio D2 to D1 On	D1DIVD2ON
D2/D1 to D2 on OFF	Ratio D2 to D1 Off	D1DIVD2OFF
DATA and MEMORY	Data and Memory	DISPDATM
DATA ARRAY ON off	Data Array On	EXTMDATAON
DATA ARRAY on OFF	Data Array Off	EXTMDATAOFF
DATA/MEM	Ratio Data to Memory	DISPDDM
DATA - MEM	Data Minus Memory	DISPDMM
DATA → MEMORY	Data to Memory	DATI
DATA ONLY ON off	Data Only On	EXTMDATOON
DATA ONLY on OFF	Data Only Off	EXTMDATOOFF
DECR LOOP COUNTER	Decrement Loop Counter	DECRLOOC
DEFAULT COLORS	Default Colors	DEFC
DEFAULT PLOT SETUP	Default Plot Setup	DFLT
DEFAULT PRINT SETUP	Default Print Setup	DEFLPRINT
DEFINE STANDARD	Define Standard	DEFS
DELAY	Delay	DELA
DELETE	Delete	SDEL
DELETE ALL FILES	Delete All Files	CLEARALL
DELTA LIMITS	Delta Limits	LIMD
DEMODO: AMPLITUDE	Demodulation Amplitude	DEMOAMPL
DEMODO: OFF	Demodulation Off	DEMOOFF
DEMODO: PHASE	Demodulation Phase	DEMOPHAS
DIRECTORY SIZE	Directory Size	DIRS
DISK UNIT NUMBER	Disk Unit Number	DISCUNIT
DISP MKRS ON off	Display Markers On	DISM
DISP MKRS on OFF	Display Markers Off	DISM

Table 9-1.
Cross Reference of Key Function to Programming Command (continued)

Key	Name	Command
DISPLAY	Display	MENUDISP
DISPLAY: DATA	Display Data	DISPDATA
DO SEQUENCE	Do Sequence	DOSEn
DONE	Done	EDITDONE
DONE (Segment)	Done	SDON
DONE 1-PORT CAL	Done 1-Port Calibration	SAV1
DONE 2-PORT CAL	Done 2-Port Calibration	SAV2
DONE RESPONSE	Done Response	RESPDONE
DONE RESP ISOL'N CAL	Done Response Isolation Cal	RAID
DONE SEQ MODIFY	Done Sequence Modify	DONM
DONE TRL/LRM	Done TRL/LRM	SAVT
DOWN CONVERTER	Down Converter	DCONV
DUAL CH ON off	Dual Channel On	DUACON
DUAL CH on OFF	Dual Channel Off	DUACOFF
DUPLICATE SEQUENCE	Duplicate Sequence	DUPLSEQxSEQy
EACH SWEEP	Calibrate Each Sweep	PWMCEACS
EDIT	Edit	SEDI
EDIT LIMIT LINE	Edit Limit Line	EDITLIML
EDIT LIST	Edit List	EDITLIST
ELECTRICAL DELAY	Electrical Delay	ELED
EMIT BEEP	Emit Beep	EMIB
END SWEEP HIGH PULSE	End Sweep High Pulse	TTLHPULS
END SWEEP LOW PULSE	End Sweep Low Pulse	TLLLPULS
Entry Off	Entry Off	ENTO
EXT TRIG ON POINT	External Trigger on Point	EXTTPOIN
EXT TRIG ON SWEEP	External Trigger on Sweep	EXTTON
EXTENSION INPUT A	Extension Input A	PORTA
EXTENSION INPUT B	Extension Input B	PORTB
EXTENSION PORT 1	Extension Port 1	PORT1

**Table 9-1.
Cross Reference of Key Function to Programming Command (continued)**

Key	Name	Command
EXTENSION PORT 2	Extension Port 2	PORT2
EXTENSIONS ON off	Extensions On	POREON
EXTENSIONS on OFF	Extensions Off	POREOFF
EXTERNAL DISK	External Disk	EXTD
FILENAME FILE0	File Name File 0	TITF0
FILETITLE FILE0	File Name File 0	TITF0
FIXED	Fixed Load	FIXE
FIXED MKR AUX VALUE	Fixed Marker Auxiliary Value	MARKFAUV
FIXED MKR POSITION	Fixed Marker Position	DELRFIXM
FIXED MKR STIMULUS	Fixed Marker Stimulus	MARKFSTI
FIXED MKR VALUE	Fixed Marker Value	MARKFVAL
FLAT LINE	Flat Line	LIMTFL
FORMAT	Format	MENUFORM
FORMAT ARY ON off	Format Array On	EXTMFORMON
FORMAT ARY on OFF	Format Array Off	EXTMFORMOFF
FORMAT: DOS	Format DOS	FORMATDOS
FORMAT: LIF	Format LIF	FORMATLIF
FORMAT EXT DISK	Format External Disk	INIE
FORMAT INT DISK	Format Internal Disk	INID
FORMAT INT MEMORY	Format Internal Memory	INTM
FREQ OFFS ON off	Frequency Offset On	FREQOFFSON
FREQ OFFS on OFF	Frequency Offset Off	FREQOFFSOFF
FREQUENCY	Frequency	CALFFREQ
FREQUENCY BLANK	Frequency Blank	FREO
FREQUENCY: CW	Frequency: CW	LOFREQ
FREQUENCY: SWEEP	Frequency: SWEEP	
FULL 2-PORT	Full 2-Port	CALIFUL2
FULL PAGE	Full Page	FULP
FWD ISOL'N ISOL'N STD	Forward Isolation	FWDI
FWD MATCH (Label Class)	Label Forward Match	LABEFWDM LABETTFM
FWD MATCH (Specify Class)	Specify Forward Match	SPECFWDM SPECTTFM
FWD MATCH THRU	Forward Match Thru	FWDM

Table 9-1.
Cross Reference of Key Function to Programming Command (continued)

Key	Name	Command
FWD TRANS (Label Class)	Label Forward Transmission	LABEFWDT LABETTFT
FWD TRANS (Specify Class)	Specify Forward Transmission	SPECFWDT SPECTTFT
FWD TRANS THRU	Forward Transmission Thru	FWDT
G+jB MKR	G+jB Marker Readout	SMIMGB
GATE: CENTER	Gate Center	GATECENT
GATE: SPAN	Gate Span	GATESPAN
GATE: START	Gate Start	GATESTAR
GATE: STOP	Gate Stop	GATESTOP
GATE ON off	Gate On	GATEOON
GATE on OFF	Gate Off	GATEOOFF
GATE SHAPE MAXIMUM	Gate Shape Maximum	GATSMAXI
GATE SHAPE MINIMUM	Gate Shape Minimum	GATSMINI
GATE SHAPE NORMAL	Gate Shape Normal	GATSNORM
GATE SHAPE WIDE	Gate Shape Wide	GATSWIDE
GOSUB SEQUENCE	GOSUB Sequence	GOSUBn
GRAPHICS ON off	Graphics On	EXTMGRAPON
GRAPHICS on OFF	Graphics Off	EXTMGRAPOFF
GRATICULE []	Print Color - graticule	PCOLGRAT
GRATICULE TEXT	Graticule	COLOGRAT
HARMONIC OFF	Harmonic Mode Off	HARMOFF
HARMONIC SECOND	Measure Second Harmonic	HARMSEC
HARMONIC THIRD	Measure Third Harmonic	HARMTHIR
HOLD	Hold	HOLD
HP-IB DIAG ON off	HP-IB Diagnostics On	DEBUON
HP-IB DIAG on OFF	HP-IB Diagnostics Off	DEBUOFF
IF BW []	IF Bandwidth	IFBW
IF LIMIT TEST FAIL	If Limit Test Fail	IFLTFAIL
IF LIMIT TEST PASS	If Limit Test Pass	IFLTPASS
IF LOOP COUNTER = 0	IF Loop Counter = 0	IFLCEQZE
IF LOOP < > COUNTER 0	IF Loop < > Counter 0	IFLCNEZE
IMAGINARY	Imaginary	IMAG
INCR LOOP COUNTER	Increment Loop Counter	INCRLOOC
INTENSITY	Intensity	INTE

Table 9-1.
Cross Reference of Key Function to Programming Command (continued)

Key	Name	Command
INTERNAL DISK	Internal Disk	INTD
INTERNAL MEMORY	Select Internal Memory	INTM
INTERPOL ON off	Interpolation On	CORION
INTERPOL on OFF	Interpolation Off	CORIOFF
ISOLATION (2-Port)	Isolation	ISOL
ISOLATION (One-Path 2-Port)	Isolation	ISOOP
ISOLATION DONE	Isolation Done	ISOD
ISOL'N STD	Isolation Standard	RAISOL
KIT DONE (MODIFIED)	Kit Done	KITD
LABEL KIT	Label Kit	LABK
LABEL STD	Label Standard	LABS
LEFT LOWER	Left lower	LEFL
LEFT UPPER	Left Upper	LEFU
LIMIT LINE ON off	Limit Line On	LIMILINEON
LIMIT LINE on OFF	Limit Line Off	LIMILINEOFF
LIMIT TEST ON off	Limit Test On	LIMITESTON
LIMIT TEST on OFF	Limit Test Off	LIMITESTOFF
LIN FREQ	Linear Frequency	LINFREQ
LIN MAG	Linear Magnitude	LINM
LIN MKR	Linear Marker	POLMLIN
LINE/MATCH	Line/Match	
LINE TYPE DATA	Line Type Data	LINTDATA
LINE TYPE MEMORY	Line Type Memory	LINTMEMO
LIST FREQ	List Frequency	LISTFREQ
LIST VALUES	List Values	LISV
LN/MATCH 1	Line/Match 1	TRLL1
LN/MATCH 2	Line/Match 1	TRLL2
LO CONTROL ON off	LO Control On	LOCONTON
LO CONTROL on OFF	LO Control Off	LOCONTOFF
LO SOURCE ADDRESS	LO Source Address	ADDRLSRC
LOAD	Load	STDTLOAD
LOAD NO OFFSET	Load No Offset	LOAN
LOAD OFFSET	Load Offset	LAO
LOAD SEQ FROM DISK	Load Sequence From Disk	LOADSEQn

Table 9-1.
Cross Reference of Key Function to Programming Command (continued)

Key	Name	Command
LOCAL	Local	
LOG FREQ	Logarithmic Frequency	LOGFREQ
LOG MAG	Logarithmic Magnitude	LOGM
LOG MKR	Logarithmic Marker	SMIMLOG
LOOP COUNTER	Loop Counter	LOOC
LOSS	Loss	POWLOSS
LOW PASS IMPULSE	Low Pass Impulse	LOWPIMPU
LOW PASS STEP	Low Pass Step	LOWPSTEP
LOWER LIMIT	Lower Limit	LIML
MANUAL TRG ON POINT	Manual Trigger On Point	MANTRIG
MARKER	Marker	MENUMARK
MARKER → CENTER	Marker to Center	MARKCENT
MARKER → CW	Marker to CW	MARKCW
MARKER → DELAY	Marker to Delay	MARKDELA
MARKER → MIDDLE	Marker to Middle	MARKMIDD
MARKER → REFERENCE	Marker to Reference	MARKREF
MARKER → SPAN	Marker to Span	MARKSPAN
MARKER → START	Marker to Start	MARKSTAR
MARKER → STIMULUS	Marker to Stimulus	MARKSTIM
MARKER → STOP	Marker to Stop	MARKSTOP
MARKER 1	Marker 1	MARK1
MARKER 2	Marker 2	MARK2
MARKER 3	Marker 3	MARK3
MARKER 4	Marker 4	MARK4
MARKER 5	Marker 5	MARK5
MARKER all OFF	All Markers Off	MARKOFF
MARKER FCTN	Marker Function	MENUMRKF
MARKERS: CONTINUOUS	Markers Continuous	MARKCONT
MARKERS: COUPLED	Markers Coupled	MARKCOUP
MARKERS: DISCRETE	Markers Discrete	MARKDISC
MARKERS: UNCOUPLED	Markers Uncoupled	MARKUNCO

**Table 9-1.
Cross Reference of Key Function to Programming Command (continued)**

Key	Name	Command
MAXIMUM FREQUENCY	Maximum Frequency	MAXF
MEAS	Measure	MENUMEAS
MEASURE RESTART	Measure Restart	REST
MEMORY	Memory	DISPMEMO
MIDDLE VALUE	Middle Value	LIMM
MINIMUM	Minimum	WINDMINI
MINIMUM FREQUENCY	Minimum Frequency	MINF
MKR SEARCH [OFF]	Marker Search Off	SEAOFF
MKR ZERO	Marker Zero	MARKZERO
MODIFY []	Modify Kit	MODI1
NETWORK ANALYZER	Network Analyzer	INSMNETA
NEW SEQ/MODIFY SEQ	New Sequence/Modify Sequence	NEWSEn
NEXT PAGE	Display Next Page of Tabular Listing	NEXP
NUMBER OF GROUPS	Number of Groups	NUMG
NUMBER OF POINTS	Number of Points	POIN
NUMBER OF READINGS	Number of Readings	NUMR
OFF	Off	CONOFF
OFFSET	Offset	OFLS
OFFSET DELAY	Offset Delay	OFSD
OFFSET LOADS DONE	Offset Loads Done	OFLD
OFFSET LOSS	Offset Loss	OFLS
OFFSET ZO	Offset Impedance	OFSZ
OMIT ISOLATION	Omit Isolation	OMII
ONE-PATH 2-PORT	One-Path 2-Port	CALIONE2
ONE SWEEP	Calibrate One Sweep	PWMCONES
OP PARMS MKRS etc	Tabular Listing of Operating Parameters	OPEP

Table 9-1.
Cross Reference of Key Function to Programming Command (continued)

Key	Name	Command
P MTR/HPIB TO TITLE	Power Meter HPIB to Title	PMTRTTIT
PARALL IN BIT NUMBER	Parallel in Bit Number	PARAIN
PARALL IN IF BIT H	Parallel in IF Bit H	IFBIHIGH
PARALL IN IF BIT L	Parallel in IF Bit L	IFBILOW
PARALLEL [COPY]	Set parallel port to copy mode	PARALCPY
PARALLEL [GPIO]	Set parallel port to GPIO mode	PARALGPIO
PARALLEL OUT ALL	Parallel Out All	PARAOUT
PAUSE	Pause	PAUS
PAUSE TO SELECT	Pause to Select	PTOS
PEN NUM DATA	Pen Number Data	PENNDATA
PEN NUM GRATICULE	Pen Number Graticule	PENNGRAT
PEN NUM MARKER	Pen Number Marker	PENNMARK
PEN NUM MEMORY	Pen Number Memory	PENNMEMO
PEN NUM TEXT	Pen Number Text	PENNTEXT
PHASE	Phase	PHAS
PHASE OFFSET	Phase Offset	PHAO
PLOT	Plot	PLOT
PLOT DATA ON off	Plot Data On	PDATAON
PLOT DATA on OFF	Plot Data Off	PDATAOFF
PLOT GRAT ON off	Plot Graticule On	PGRATON
PLOT GRAT on OFF	Plot Graticule Off	PGRATOFF
PLOT MEM ON off	Plot Memory On	PMEMON
PLOT MEM on OFF	Plot Memory Off	PMEMOFF
PLOT MKR ON off	Plot Marker ON	PMKRON
PLOT MKR on OFF	Plot Marker Off	PMKROFF
PLOTNAME PLOTFILE	Plot name Plot file	TITP
PLOT SPEED [FAST]	Plot Speed Fast	PLOFAST
PLOT SPEED [SLOW]	Plot Speed Slow	PLOSSLOW
PLOT TEXT ON off	Plot Text On	PTEXTON

Table 9-1.
Cross Reference of Key Function to Programming Command (continued)

Key	Name	Command
PLOT TEXT on OFF	Plot Text Off	PTEXTOFF
PLOTTER BAUD RATE	Plotter Baud Rate	PLTRRBAUD
PLOTTER FORM FEED	Plotter Form Feed	PLTRRFORF
PLTR PORT: DISK	Plotter Port Disk	PLTPRTDISK
PLTR PORT: HPIB	Plotter Port HPIB	PLTPRTHPIB
PLTR PORT: PARALLEL	Plotter Port Parallel	PLTPRTPARA
PLTR PORT: SERIAL	Plotter Port Serial	PLTPRTSERI
PLTR TYPE [PLOTTER]	Plot to a Plotter	PLTTYPPLTR
PLTR TYPE [HPGL PRT]	Plot to a HP-GL/2 Compatible Printer	PLTTYHPHGL
POLAR	Polar	POLA
PORT PWR [COUPLED]	Port Power Coupled	PORTPCPLD
PORT PWR [UNCOUPLED]	Port Power Uncoupled	PORTPUNCPLD
POWER	Power	POWE
POWER: FIXED	Power Fixed	LOPOWER
POWER: SWEEP	Power Sweep Mode	LOPSWE
POWER MTR	Power Meter	POWM
POWER MTR: [436A]	Power Meter 436A	POWMON
POWER MTR: [437B/438A]	Power Meter 437B/438A	POWMOFF
POWER RANGES	Power Ranges	PWRR
POWER SWEEP	Power Sweep	POWS
PRESET	Factory Preset	RST PRES
PRESET: FACTORY	Factory Preset	RST PRES
PREVIOUS PAGE	Previous Page	PREP
PRINT ALL COLOR	Print Entire List - Color	PRINTALL
PRINT ALL MONOCHROME	Print Entire List - Monochrome	PRINTALL
PRINT: COLOR	Selects Color Printer	PRIC
PRINT COLOR	Print Color	PRINALL
PRINT: MONOCHROME	Selects Monochrome Printer	PRIS

Table 9-1.
Cross Reference of Key Function to Programming Command (continued)

Key	Name	Command
PRINT MONOCHROME	Print Monochrome	PRINALL
PRINT SEQUENCE	Print Sequence	PRINSEQn
PRINTER BAUD RATE	Printer Baud Rate	PRNTRBAUD
PRINTER FORM FEED	Printer Form Feed	PRNTRFORF
PRNTR PORT: HPIB	Printer Port HPIB	PRNPRTHPIB
PRNTR PORT: PARALLEL	Printer Port Parallel	PRNPRTPARA
PRNTR PORT: SERIAL	Printer Port Serial	PRNPRTSERI
PRNTR TYPE [DESKJET]	DeskJet Printer	PRNTYPDJ
PRNTR TYPE [EPSON-P2]	EPSON ESC/P2 Printer Central Language	PRNTYPEP
PRNTR TYPE [LASERJET]	LaserJet Printer	PRNTYPLJ
PRNTR TYPE [PAINTJET]	PaintJet Printer	PRNTYPPJ
PRNTR TYPE [THINKJET]	ThinkJet Printer	PRNTYPTJ
PWR LOSS ON off	Power Loss On	PWRLOSSON
PWR LOSS on OFF	Power Loss Off	PWRLOSSOFF
PWR RANGE AUTO man	Power Range Auto	PWRRPAUTO
PWR RANGE auto MAN	Power Range Man	PWRRPMAN
PWRMTR CAL []	Power Meter Calibration	CALPOW
PWRMTR CAL [OFF]	Power Meter Calibration Off	PWRMMCALOFF
R	Measure Channel R	MEASR
R+jX MKR	R+jX Marker Readout	SMIMRX
RANGE 0 -15 TO +10	Power Range 0	PRAN0
RANGE 1 -25 TO 0	Power Range 1	PRAN1
RANGE 2 -35 TO -10	Power Range 2	PRAN2
RANGE 3 -45 TO -20	Power Range 3	PRAN3
RANGE 4 -55 TO -30	Power Range 4	PRAN4
RANGE 5 -65 TO -40	Power Range 5	PRAN5
RANGE 6 -75 TO -50	Power Range 6	PRAN6
RANGE 7 -85 TO -60	Power Range 7	PRAN7
RAW ARRAY ON off	Raw Array On	EXTMRAWON
RAW ARRAY on OFF	Raw Array Off	EXTMRAWOFF
RAW OFFSET ON Off	Raw Offset	RAWOFFON
RAW OFFSET On OFF	Raw Offset	RAWOFFSOFF
Re/Im MKR	Real/Imaginary Markers	POLMRI

**Table 9-1.
Cross Reference of Key Function to Programming Command (continued)**

Key	Name	Command
READ FILE TITLES	Read File Titles	REFT
REAL	Real	REAL
RECALL COLORS	Recall Colors	RECO
RECALL REG1	Recall Register 1	RECA1
RECALL REG2	Recall Register 2	RECA2
RECALL REG3	Recall Register 3	RECA3
RECALL REG4	Recall Register 4	RECA4
RECALL REG5	Recall Register 5	RECA5
RECALL REG6	Recall Register 6	RECA6
RECALL REG7	Recall Register 7	RECA7
RECALL STATE	Recall State	RECA RECAREG
RECEIVER CAL	Receiver Calibration	REIC
REFERENCE POSITION	Reference Position	REFP
REFERENCE VALUE	Reference Value	REFV
REFL: FWD S11 (A/R)	Reflection Forward S11 A/R	RFLP S11
REFL: REV S22 (B/R)	Reflection Reverse S22 B/R	S22
REFLECTION	Reflection	REFOP
REMOVE ADAPTER	Remove Adapter	MODS
RESET COLOR	Reset Color	RSCO
RESPONSE (Calibrate)	Response	CALIRESP
RESPONSE (Label Class)	Response	LABERESP
RESPONSE (Specify Class)	Response	SPECRESP
RESPONSE & ISOL'N (Calibrate)	Response and Isolation	CALIRAI
RESPONSE & ISOL'N (Label Class)	Response and Isolation	LABERESI
RESPONSE & ISOL'N (Specify Class)	Response and Isolation	SPECRESI
RESTORE DISPLAY	Restore Display	RESD

Table 9-1.
Cross Reference of Key Function to Programming Command (continued)

Key	Name	Command
RESUME CAL SEQUENCE	Resume Calibration Sequence	RESC
REV ISOL'N ISOL'N STD	Reverse Isolation	REVI
REV MATCH (Label Class)	Label Reverse Match	LABEREVM LABETTRM
REV MATCH (Specify Class)	Specify Reverse Match	SPECREVM SPECTTRM
REV MATCH THRU	Reverse Match Thru	REVM
REV TRANS (Label Class)	Label Reverse Transmission	LABEREVT LABETTRT
REV TRANS (Specify Class)	Specify Reverse Transmission	SPECREVT SPECTTRT
REV TRANS THRU	Reverse Transmission Thru	REVT
RF > LO	RF Greater Than LO	RFGTLO
RF < LO	RF Less Than LO	RFLTLO
RIGHT LOWER	Right Lower	RIGL
RIGHT UPPER	Right Upper	RIGU
S11 1-PORT	S ₁₁ 1-Port	CALIS111
S11A (Label Class)	S ₁₁ A Reflected Forward Match	LABES11A LABETRFM
S11A (Specify Class)	S ₁₁ A Reflected Forward Match	SPECS11A SPECTRFM
S11B (Label Class)	S ₁₁ B Line Forward Match	LABES11B LABETRRM
S11B (Specify Class)	S ₁₁ B Line Forward Match	SPECS11B SPECTRRM
S11C (Label Class)	S ₁₁ C Line Forward Transmission	LABES11C LABETLFT
S11C (Specify Class)	S ₁₁ C Line Forward Transmission	SPECS11C SPECTLFT
S11 REFL OPEN	S ₁₁ Reflect Short	TRLR1
S22 1-PORT	S ₂₂ 1-Port	CALIS221
S22A (Label Class)	S ₂₂ A Reflected Reverse Match	LABES22A LABETRRM
S22A (Specify Class)	S ₂₂ A Reflected Reverse Match	SPECS22A SPECTRRM

**Table 9-1.
Cross Reference of Key Function to Programming Command (continued)**

Key	Name	Command
S22B (Label Class)	S ₂₂ B Line Reverse Transmission	LABES22B LABETLRM
S22B (Specify Class)	S ₂₂ B Line Reverse Transmission	SPECS22B SPECTLRM
S22C (Label Class)	S ₂₂ C Line Reverse Transmission	LABES22C LABETLRT
S22C (Specify Class)	S ₂₂ C Line Reverse Transmission	SPECS22C SPECTLRT
S22 REFL OPEN	S ₂₂ Reflect Short	TRLR2
SAMPLR COR ON off	Sampler Correction On	SAMCON
SAMPLR COR on OFF	Sampler Correction Off	SAMCOFF
SAVE COLORS	Save Colors	SVCO
SAVE USER KIT	Save User Kit	SAVEUSEK
SAVE USING ASCII	Save ASCII Format	SAVUASCI
SAVE USING BINARY	Save Using Binary	SAVUBINA
SCALE/DIV	Scale/Division	SCAL
SCALE PLOT [FULL]	Scale Plot Full	SCAPFULL
SCALE PLOT [GRAT]	Scale Plot Graticule	SCAPGRAT
SCALE REF	Scale Reference	MENUSCAL
SEARCH LEFT	Search Left	SEAL
SEARCH RIGHT	Search Right	SEAR
SEARCH: MAX	Search Maximum	SEAMAX
SEARCH: MIN	Search Minimum	SEAMIN
SEARCH: OFF	Search Off	SEAOFF
SECOND	Second Harmonic	HARMSEC
SEGMENT: CENTER	Segment Center	CENT
SEGMENT: SPAN	Segment Span	SPAN
SEGMENT: START	Segment Start	STAR
SEGMENT: STOP	Segment Stop	STOP
SEQUENCE 1 SEQ1	Select Sequence 1	SEQ1 Q1
SEQUENCE 2 SEQ2	Select Sequence 2	SEQ2 Q2
SEQUENCE 3 SEQ3	Select Sequence 3	SEQ3 Q3

Table 9-1.
Cross Reference of Key Function to Programming Command (continued)

Key	Name	Command
SEQUENCE 4 SEQ4	Select Sequence 4	SEQ4 Q4
SEQUENCE 5 SEQ5	Select Sequence 5	SEQ5 Q5
SEQUENCE 6 SEQ6	Select Sequence 6	SEQ6 Q6
SEQUENCE 1 SEQ1	Select Sequence 1 to Title	TITSEQ1
SEQUENCE 2 SEQ2	Select Sequence 2 to Title	TITSEQ2
SEQUENCE 3 SEQ3	Select Sequence 3 to Title	TITSEQ3
SEQUENCE 4 SEQ4	Select Sequence 4 to Title	TITSEQ4
SEQUENCE 5 SEQ5	Select Sequence 5 to Title	TITSEQ5
SEQUENCE 6 SEQ6	Select Sequence 6 to Title	TITSEQ6
SET BIT	Set Bit	SETBIT
SET DATE	Set Date	SETDATE
SET FREQ LOW PASS	Set Frequency Low Pass	SETF
SET REF: REFLECT	Set Reference: Reflect	SETRREFL
SET REF: THRU	Set Reference: Thru	SETRTHRU
SET TIME	Set Time	SETTIME
SET ZO	Set Impedance	SETZ
SHOW MENUS	Show Menus	SHOM
SINGLE	Single	SING
SINGLE POINT	Single Point	LIMITSP
SINGLE SEG SWEEP	Single Segment Sweep	SSEG
SLIDING	Sliding	SLIL
SLOPE	Slope	SLOPE
SLOPE ON off	Slope On	SLOPON
SLOPE on OFF	Slope On	SLOPOFF
SLOPING LINE	Sloping Line	LIMITSL
SMITH CHART	Smith Chart	SMIC
SMOOTHING APERTURE	Smoothing Aperture	SMOOPER
SMOOTHING ON off	Smoothing On	SMOON
SMOOTHING on OFF	Smoothing Off	SMOOFF

Table 9-1.
Cross Reference of Key Function to Programming Command (continued)

Key	Name	Command
SOURCE PWR ON off	Source Power On	SOUPON POWTOFF
SOURCE PWR on OFF	Source Power Off	SOUPOFF POWTON
SPAN	Span	SPAN
SPECIFY GATE	Specify Gate	SPEG
SPLIT DISP ON off	Split Display On	SPLDON
SPLIT DISP on OFF	Split Display Off	SPLDOFF
SPUR AVOID ON Off	Spur Avoidance On	SM8ON
SPUR AVOID On OFF	Spur Avoidance Off	SM8OFF
(START)	Start	LOFSTAR
START	Start	STAR
STATS ON off	Statistics On	MEASTATON
STATS on OFF	Statistics Off	MEASTATOFF
STD DONE (DEFINED)	Standard Done	STDD
STD TYPE: ARBITRARY IMPEDANCE	Standard Type: Arbitrary Impedance	STDTARBI
STD TYPE: DELAY/THRU	Standard Type: Delay/Thru	STDTDELA
STD TYPE: LOAD	Standard Type: Load	STDTLOAD
STD TYPE: OPEN	Standard Type: Open	STDTOPEN
STD TYPE: SHORT	Standard Type: Short	STDTSHOR
STEP SIZE	Step Size	STPSIZE
STIMULUS VALUE	Stimulus Value	LIMS
STIMULUS OFFSET	Stimulus Offset	LIMISTIO
(STOP)	Stop	LOFSTOP
STOP	Stop	STOP
STORE SEQ TO DISK	Store Sequence to Disk	STORSEQn
SWEEP	Sweep Mode	LOFSWE
SWEEP TIME []	Sweep Time	SWET
SWEEP TIME [AUTO]	Sweep Time	SWEA
SWR	SWR	SWR
(SYSTEM)	System	MENUSYST
SYSTEM CONTROLLER	System Controller	
TAKE CAL SWEEP	Take Calibration Sweep	TAKCS
TAKE RCVR CAL SWEEP	Take Receiver Calibration Sweep	TAKRS

**Table 9-1.
Cross Reference of Key Function to Programming Command (continued)**

Key	Name	Command
TALKER/LISTENER	Talker/Listener	TALKLIST
TARGET	Target	SEATARG
TERMINAL IMPEDANCE	Terminal Impedance	TERI
TESTPORT (1) 2	Testport 1	TSTPP1
TESTPORT 1 (2)	Testport 2	TSTPP2
TESTSET I/O FWD	Testset I/O Forward	TSTIOFWD
TESTSET I/O REV	Testset I/O Reverse	TSTIOREV
TESTSET SW XXXX	Testset Switching XXXX	TSSWI
		CSWI
TEXT	Text	COLOTEXT
TEXT []	Print Color - Text	PCOLTEXT
THRU THRU	Thru Thru	TRLT
TIME STAMP ON off	Time Stamp On	TIMESTAMON
TIME STAMP on OFF	Time Stamp Off	TIMESTAMOFF
TINT	Tint	TINT
TITLE	Title	TITL
TITLE FILE1	Title File 1	TITF1
TITLE FILE2	Title File 2	TITF2
TITLE FILE3	Title File 3	TITF3
TITLE FILE4	Title File 4	TITF4
TITLE FILE5	Title File 5	TITF5
TITLE SEQUENCE	Title Sequence	TITSQ
TITLE TO MEMORY	Title to Memory	TITTMEM
TITLE TO P MTR/HPIB	Title to Power Meter/HPIB	TITTPMTR
TITLE TO PERIPHERAL	Title to HP-IB Peripheral	TITTPERI
TITLE TO PRNTR/HPIB	Title to HP-IB Printer	TITTPRIN
TRACKING ON off	Tracking On	TRACKON
TRACKING on OFF	Tracking Off	TRACKOFF
TRANS DONE	Transmission Done	TRAD
TRANS: FWD S21 (B/R)	Transmission Forward S21 B/R	S21
		TRAP
TRANS: REV S12 (A/R)	Transmission Reverse S12 A/R	S12
TRANSFORM ON off	Transform On	TIMDTRANON
TRANSFORM on OFF	Transform Off	TIMDTRANOFF

Table 9-1.
Cross Reference of Key Function to Programming Command (continued)

Key	Name	Command
TRANSMISSION	Transmission	FWDT
TRIGGER: TRIG OFF	External Trigger Off	EXTTOFF
TRL*/LRM* 2-PORT	Thru, Reflect, Line/Line, Reflect, Match	CALITRL2
TRL/LRM OPTION	Thru, Reflect, Line/Line, Reflect, Match	
TRL LINE OR MATCH (Specify Class)	TRL Line or Match	SPECTRLL
TRL LINE OR MATCH (Label Class)	TRL Line or Match	LABETRLR
TRL THRU (Specify Class)	TRL Thru	SPECTRLT
TRL THRU (Label Class)	TRL Thru	LABETRLT
TRL REFLECT (Specify Class)	TRL Reflect	SPECTRLR
TRL REFLECT (Label Class)	TRL Reflect	LABETRLR
TTL OUT HIGH	TTL Out High	TTLOH
TTL OUT LOW	TTL Out Low	TTLOL
TUNED RECEIVER	Tuned Receiver	INSMTUNR
UNCOUPLED	Uncoupled	UNCPLD
UP CONVERTER	Up Converter	UCONV
UPPER LIMIT	Upper Limit	LIMU
USE MEMORY ON off	Use Memory On	WINDUSEMON
USE MEMORY on OFF	Use Memory Off	WINDUSEMOFF
USE PASS CONTROL	Use Pass Control	USEPASC
USE SENSOR (A) / B	Use Sensor A	ENSA
USE SENSOR A / (B)	Use Sensor B	ENSB
VELOCITY FACTOR	Velocity Factor	VELOFACT
VIEW MEASURE	View Measure	VIEM
VOLUME NUMBER	Volume Number	DISCVOLU
WAIT x	Wait x Seconds	SEQWAIT

Table 9-1.
Cross Reference of Key Function to Programming Command (continued)

Key	Name	Command
WARNING	Warning	COLOWARN
WARNING []	Print Color Warning	PCOLWARN
WAVEGUIDE	Waveguide	WAVE
WAVEGUIDE DELAY	Waveguide Delay	WAVD
WHITE	White	WHITE
WIDTH VALUE	Width Value	WIDV
WIDTHS ON off	Widths On	WIDTON
WIDTHS on OFF	Widths Off	WIDTOFF
WINDOW	Window	WINDOW
WINDOW: MAXIMUM	Window Maximum	WINDMAXI
WINDOW: MINIMUM	Window Minimum	WINDMINI
WINDOW: NORMAL	Window Normal	WINDNORM
XMIT CNTRL [Xon-Xoff]	Transmit Control (printer)	PRNHNDSHKXON
XMIT CNTRL [DTR-DSR]	Transmit Control (printer)	PRNHNDSHKDTR
XMIT CNTRL [Xon-Xoff]	Transmit Control (plotter)	PLTHNDSHKXON
XMIT CNTRL [DTR-DSR]	Transmit Control (plotter)	PLTHNDSHKDTR
Y: REFL	Y: Reflection	CONVYREF
Y: TRANS	Y: Transmission	CONVYTRA
YELLOW	Yellow	YELLOW
Z: REFL	Z: Reflection	CONVZREF
Z: TRANS	Z: Transmission	CONVZTRA

Softkey Locations

The following table lists the softkey functions alphabetically, and the corresponding front-panel access key. This table is useful in determining which front-panel key leads to a specific softkey.

Table 9-2. Softkey Locations

Softkey	Front-Panel Access Key
Δ MODE MENU	(MARKER)
Δ MODE OFF	(MARKER)
Δ REF = 1	(MARKER)
Δ REF = 2	(MARKER)
Δ REF = 3	(MARKER)
Δ REF = 4	(MARKER)
Δ REF = 5	(MARKER)
Δ REF = Δ FIXED MKR	(MARKER)
1/S	(MEAS)
A	(MEAS)
A/B	(MEAS)
A/R	(MEAS)
ACTIVE ENTRY	(DISPLAY)
ACTIVE MRK MAGNITUDE	(DISPLAY)
ADAPTER: COAX	(CAL)
ADAPTER: WAVEGUIDE	(CAL)
ADAPTER DELAY	(CAL)
ADAPTER REMOVAL	(CAL)
ADDRESS: 8753	(LOCAL)
ADDRESS: CONTROLLER	(LOCAL)
ADDRESS: DISK	(LOCAL)
ADDRESS: DISK	(SAVE/RECALL)
ADDRESS: P MTR/HPIB	(LOCAL)
ADJUST DISPLAY	(DISPLAY)
ALL OFF	(MARKER)
ALL SEGS SWEEP	(MENU)
ALTERNATE A and B	(CAL)
AMPLITUDE	(SYSTEM)
AMPLITUDE OFFSET	(SYSTEM)
ANALOG IN Aux Input	(MEAS)
ARBITRARY IMPEDANCE	(CAL)
ASSERT SRQ	(SEQ)

Table 9-2. Softkey Locations (continued)

Softkey	Front-Panel Access Key
AUTO FEED on OFF	(COPY)
AUTO SCALE	(SCALE REF)
AVERAGING FACTOR	(AVG)
AVERAGING on OFF	(AVG)
AVERAGING RESTART	(AVG)
B	(MEAS)
B/R	(MEAS)
BACKGROUND INTENSITY	(DISPLAY)
BANDPASS	(SYSTEM)
BEEP DONE ON off	(DISPLAY)
BEEP FAIL on OFF	(SYSTEM)
BEEP WARN on OFF	(DISPLAY)
BLANK DISPLAY	(DISPLAY)
BRIGHTNESS	(DISPLAY)
C0	(CAL)
C1	(CAL)
C2	(CAL)
C3	(CAL)
CAL FACTOR	(CAL)
CAL FACTOR SENSOR A	(CAL)
CAL FACTOR SENSOR B	(CAL)
CAL KIT []	(CAL)
CAL KIT: 2.4mm	(CAL)
CAL KIT: 2.92*	(CAL)
CAL KIT: 2.92mm	(CAL)

Table 9-2. Softkey Locations (continued)

Softkey	Front-Panel Access Key
CAL KIT: 3.5mmC	<input type="button" value="CAL"/>
CAL KIT: 3.5mmD	<input type="button" value="CAL"/>
CAL KIT: TRL 3.5mm	<input type="button" value="CAL"/>
CAL KIT: 7mm	<input type="button" value="CAL"/>
CAL KIT: N 50Ω	<input type="button" value="CAL"/>
CAL KIT: N 75Ω	<input type="button" value="CAL"/>
CAL KIT: USER KIT	<input type="button" value="CAL"/>
CAL Z0: LINE Z0	<input type="button" value="CAL"/>
CAL Z0: SYSTEM Z0	<input type="button" value="CAL"/>
CALIBRATE MENU	<input type="button" value="CAL"/>
CALIBRATE: NONE	<input type="button" value="CAL"/>
CH1 DATA []	<input type="button" value="COPY"/>
CH1 DATA LIMIT LN	<input type="button" value="DISPLAY"/>
CH1 MEM	<input type="button" value="DISPLAY"/>
CH1 MEM []	<input type="button" value="COPY"/>
CH2 DATA []	<input type="button" value="COPY"/>
CH2 DATA LIMIT LN	<input type="button" value="DISPLAY"/>
CH2 MEM []	<input type="button" value="COPY"/>
CH2 MEM REF LINE	<input type="button" value="DISPLAY"/>
CH PWR [COUPLED]	<input type="button" value="MENU"/>
CH PWR [UNCOUPLED]	<input type="button" value="MENU"/>
CHOP A and B	<input type="button" value="CAL"/>
CLEAR BIT	<input type="button" value="SEQ"/>
CLEAR LIST	<input type="button" value="MENU"/>
CLEAR SEQUENCE	<input type="button" value="SEQ"/>
COAX	<input type="button" value="CAL"/>
COAXIAL DELAY	<input type="button" value="SCALE REF"/>
COLOR	<input type="button" value="DISPLAY"/>
CONFIGURE	<input type="button" value="SYSTEM"/>
CONFIGURE EXTERNAL DISK	<input type="button" value="SAVE/RECALL"/>
CONTINUE SEQUENCE	<input type="button" value="SEQ"/>
CONTINUOUS	<input type="button" value="MENU"/>

Table 9-2. Softkey Locations (continued)

Softkey	Front-Panel Access Key
CONVERSION []	(MEAS)
CORRECTION on OFF	(CAL)
COUPLED CH on OFF	(MENU)
CW FREQ	(MENU)
CW TIME	(MENU)
D2/D1 to D2 on OFF	(DISPLAY)
DATA and MEMORY	(DISPLAY)
DATA ARRAY on OFF	(SAVE/RECALL)
DATA/MEM	(DISPLAY)
DATA - MEM	(DISPLAY)
DATA → MEMORY	(DISPLAY)
DATA ONLY on OFF	(SAVE/RECALL)
DECISION MAKING	(SEQ)
DECR LOOP COUNTER	(SEQ)
DEFAULT COLORS	(DISPLAY)
DEFAULT PLOT SETUP	(COPY)
DEFAULT PRINT SETUP	(COPY)
DEFINE DISK-SAVE	(SAVE/RECALL)
DEFINE PLOT	(COPY)
DEFINE PRINT	(COPY)
DEFINE STANDARD	(CAL)
DELAY	(FORMAT)
DELAY/THRU	(CAL)
DELETE ALL FILES	(SAVE/RECALL)
DELETE FILE	(SAVE/RECALL)
DELTA LIMITS	(SYSTEM)
DEMOD: AMPLITUDE	(SYSTEM)
DEMOD: OFF	(SYSTEM)
DEMOD: PHASE	(SYSTEM)
DIRECTORY SIZE (LIF)	(SAVE/RECALL)

Table 9-2. Softkey Locations (continued)

Softkey	Front-Panel Access Key
DISK UNIT NUMBER	LOCAL
DISK UNIT NUMBER	SAVE/RECALL
DISPLAY: DATA	DISPLAY
DISP MKRS ON off	MARKER FCTN
DO BOTH FWD + REV	CAL
DO SEQUENCE	SEQ
DONE 1-PORT CAL	CAL
DONE 2-PORT CAL	CAL
DONE RESPONSE	CAL
DONE RESP ISOL'N CAL	CAL
DONE SEQ MODIFY	SEQ
DONE TRL/LRM	CAL
DOWN CONVERTER	SYSTEM
DUAL CH on OFF	DISPLAY
DUMP GRAPH on OFF	SYSTEM
DUPLICATE SEQUENCE	SEQ
EACH SWEEP	CAL
EDIT LIMIT LINE	SYSTEM
EDIT LIST	MENU
ELECTRICAL DELAY	SCALE REF
EMIT BEEP	SEQ
END OF LABEL	DISPLAY
END SWEEP HIGH PULSE	SEQ
END SWEEP LOW PULSE	SEQ
ERASE TITLE	CAL
ERASE TITLE	DISPLAY
ERASE TITLE	SAVE/RECALL
EXT SOURCE AUTO	SYSTEM
EXT SOURCE MANUAL	SYSTEM

Table 9-2. Softkey Locations (continued)

Softkey	Front-Panel Access Key
EXT TRIG ON POINT	(MENU)
EXT TRIG ON SWEEP	(MENU)
EXTENSION INPUT A	(CAL)
EXTENSION INPUT B	(CAL)
EXTENSION PORT 1	(CAL)
EXTENSION PORT 2	(CAL)
EXTENSIONS on OFF	(CAL)
EXTERNAL DISK	(SAVE/RECALL)
FILETITLE FILE0	(SAVE/RECALL)
FILENAME	(SAVE/RECALL)
FILE UTILITES	(SAVE/RECALL)
FIXED	(CAL)
FIXED MKR AUX VALUE	(MARKER)
FIXED MKR POSITION	(MARKER)
FIXED MKR STIMULUS	(MARKER)
FIXED MKR VALUE	(MARKER)
FLAT LINE	(SYSTEM)
FORM FEED	(DISPLAY)
FORMAT ARY on OFF	(SAVE/RECALL)
FORMAT DISK	(SAVE/RECALL)
FORMAT: DOS	(SAVE/RECALL)
FORMAT: LIF	(SAVE/RECALL)
FORMAT EXT DISK	(SAVE/RECALL)
FORMAT INT DISK	(SAVE/RECALL)
FORMAT INT MEMORY	(SAVE/RECALL)
FREQ OFFS MENU	(SYSTEM)
FREQ OFFS on OFF	(SYSTEM)
FREQUENCY	(CAL)
FREQUENCY BLANK	(DISPLAY)
FREQUENCY: CW	(SYSTEM)
FREQUENCY: SWEEP	(SYSTEM)
FULL 2-PORT	(CAL)

Table 9-2. Softkey Locations (continued)

Softkey	Front-Panel Access Key
FULL PAGE	(COPY)
FWD ISOL'N ISOL'N STD	(CAL)
FWD MATCH	(CAL)
FWD MATCH THRU	(CAL)
FWD TRANS	(CAL)
FWD TRANS THRU	(CAL)
G+jB MKR	(MARKER)
GATE: CENTER	(SYSTEM)
GATE: SPAN	(SYSTEM)
GATE: START	(SYSTEM)
GATE: STOP	(SYSTEM)
GATE on OFF	(SYSTEM)
GATE SHAPE	(SYSTEM)
GATE SHAPE MAXIMUM	(SYSTEM)
GATE SHAPE MINIMUM	(SYSTEM)
GATE SHAPE NORMAL	(SYSTEM)
GOSUB SEQUENCE	(SEQ)
GRAPHICS on OFF	(SAVE/RECALL)
GRATICULE []	(COPY)
GRATICULE TEXT	(DISPLAY)
HARMONIC MEAS	(SYSTEM)
HARMONIC OFF	(SYSTEM)
HARMONIC SECOND	(SYSTEM)
HARMONIC THIRD	(SYSTEM)
HELP ADAPT REMOVAL	(CAL)
HOLD	(MENU)
HP-IB DIAG on off	(LOCAL)
IF BW []	(AVG)
IF LIMIT TEST FAIL	(SEQ)
IF LIMIT TEST PASS	(SEQ)
IF LOOP COUNTER = 0	(SEQ)
IF LOOP < > COUNTER 0	(SEQ)
IMAGINARY	(FORMAT)
INCR LOOP COUNTER	(SEQ)

Table 9-2. Softkey Locations (continued)

Softkey	Front-Panel Access Key
INIT DISK? YES	SAVE/RECALL
INITIALIZE DISK	SAVE/RECALL
INPUT PORTS	MEAS
INSTRUMENT MODE	SYSTEM
INTENSITY	DISPLAY
INTERNAL DISK	SAVE/RECALL
INTERNAL MEMORY	SAVE/RECALL
INTERPOL on OFF	CAL
ISOLATION	CAL
ISOLATION DONE	CAL
ISOL'N STD	CAL
ISTATE CONTENTS	SAVE/RECALL
KIT DONE (MODIFIED)	CAL
LABEL CLASS	CAL
LABEL CLASS DONE	CAL
LABEL KIT	CAL
LABEL STD	CAL
LEFT LOWER	COPY
LEFT UPPER	COPY
LIMIT LINE OFFSETS	SYSTEM
LIMIT LINE on OFF	SYSTEM
LIMIT MENU	SYSTEM
LIMIT TEST on OFF	SYSTEM
LIMIT TEST RESULT	DISPLAY
LIMIT TYPE	SYSTEM
LIN FREQ	MENU
LIN MAG	FORMAT
LIN MKR	MARKER FCTN
LIST FREQ	MENU
LINE/MATCH	CAL
LINE TYPE DATA	COPY
LINE TYPE MEMORY	COPY
LIST	COPY

Table 9-2. Softkey Locations (continued)

Softkey	Front-Panel Access Key
LN/MATCH 1	CAL
LN/MATCH 2	CAL
LO CONTROL on OFF	SYSTEM
LO MENU	SYSTEM
LO SOURCE ADDRESS	SYSTEM
LOAD	CAL
LOAD NO OFFSET	CAL
LOAD OFFSET	CAL
LOAD SEQ FROM DISK	SEQ
LOG FREQ	MENU
LOG MAG	FORMAT
LOG MKR	MARKER FCTN
LOOP COUNTER	SEQ
LOOP COUNTER	DISPLAY
LOSS	CAL
LOSS/SENSR LISTS	CAL
LOWER LIMIT	SYSTEM
LOW PASS IMPULSE	SYSTEM
LOW PASS STEP	SYSTEM
MANUAL TRG ON POINT	MENU
MARKER → AMP. OFS.	SYSTEM
MARKER → CENTER	MARKER FCTN

Table 9-2. Softkey Locations (continued)

Softkey	Front-Panel Access Key
MARKER → CW	(SEQ)
MARKER → DELAY	(MARKER FCTN)
MARKER → DELAY	(SCALE REF)
MARKER → MIDDLE	(SYSTEM)
MARKER → REFERENCE	(MARKER FCTN)
MARKER → REFERENCE	(SCALE REF)
MARKER → SPAN	(MARKER FCTN)
MARKER → START	(MARKER FCTN)
MARKER → STIMULUS	(SYSTEM)
MARKER → STOP	(MARKER FCTN)
MARKER 1	(MARKER)
MARKER 2	(MARKER)
MARKER 3	(MARKER)
MARKER 4	(MARKER)
MARKER 5	(MARKER)
MARKER all OFF	(MARKER)
MARKER MODE MENU	(MARKER)
MARKERS: CONTINUOUS	(MARKER)
MARKERS: COUPLED	(MARKER)
MARKERS: DISCRETE	(MARKER)
MARKERS: UNCOUPLED	(MARKER)
MAX	(MARKER FCTN)
MAXIMUM FREQUENCY	(CAL)
MEASURE RESTART	(MENU)
MEMORY	(DISPLAY)
MIDDLE VALUE	(SYSTEM)
MIN	(MARKER FCTN)
MINIMUM	(SYSTEM)
MINIMUM FREQUENCY	(CAL)
MKR SEARCH []	(MARKER FCTN)
MKR ZERO	(MARKER)
MODIFY []	(CAL)

Table 9-2. Softkey Locations (continued)

Softkey	Front-Panel Access Key
MODIFY COLORS	DISPLAY
NETWORK ANALYZER	SYSTEM
NEW SEQ/MODIFY SEQ	SEQ
NEWLINE	DISPLAY
NEXT PAGE	COPY
NORMAL	SYSTEM
NUMBER OF GROUPS	MENU
NUMBER OF POINTS	MENU
NUMBER OF READINGS	CAL
OFFSET	CAL
OFFSET DELAY	CAL
OFFSET LOADS DONE	CAL
OFFSET LOSS	CAL
OFFSET ZO	CAL
OMIT ISOLATION	CAL
ONE-PATH 2-PORT	CAL
ONE SWEEP	CAL
OPEN	CAL
OP PARS (MKRS etc)	COPY
P MTR/HPIB TO TITLE	SEQ
PARALL IN BIT NUMBER	SEQ
PARALL IN IF BIT H	SEQ
PARALL IN IF BIT L	SEQ
PARALLEL	LOCAL
PARALLEL []	LOCAL
PARALLEL OUT ALL	SEQ
PAUSE TO SELECT	SEQ
PEN NUM DATA	COPY

Table 9-2. Softkey Locations (continued)

Softkey	Front-Panel Access Key
PEN NUM GRATICULE	(COPY)
PEN NUM MARKER	(COPY)
PEN NUM MEMORY	(COPY)
PEN NUM TEXT	(COPY)
PERIPHERAL HPIB ADDR	(SEQ)
PHASE	(FORMAT)
PHASE	(SYSTEM)
PHASE OFFSET	(SCALE REF)
PLOT	(COPY)
PLOT DATA ON off	(COPY)
PLOT GRAT ON off	(COPY)
PLOT MEM ON off	(COPY)
PLOT MKR ON off	(COPY)
PLOT SPEED []	(COPY)
PLOT TEXT ON off	(COPY)
PLOTTER BAUD RATE	(LOCAL)
PLOTTER FORM FEED	(COPY)
PLOTTER PORT	(LOCAL)
PLTR PORT: DISK	(LOCAL)
PLTR PORT: HPIB	(LOCAL)
PLTR PORT: PARALLEL	(LOCAL)
PLTR PORT: SERIAL	(LOCAL)
PLTR TYPE []	(LOCAL)
POLAR	(FORMAT)
POLAR MKR MENU	(MARKER)
PORT EXTENSIONS	(CAL)
PORT PWR [COUPLED]	(MENU)
PORT PWR [UNCOUPLED]	(MENU)
POWER	(MENU)
POWER: FIXED	(SYSTEM)
POWER: SWEEP	(SYSTEM)
POWER LOSS	(CAL)
POWER MTR []	(LOCAL)
POWER RANGES	(MENU)
POWER SWEEP	(MENU)

Table 9-2. Softkey Locations (continued)

Softkey	Front-Panel Access Key
PRESET: FACTORY	PRESET
PRESET: USER	PRESET
PREVIOUS PAGE	COPY
PRINT: COLOR	COPY
PRINT COLORS	COPY
PRINT: MONOCHROME	COPY
PRINT MONOCHROME	COPY
PRINT SEQUENCE	SEQ
PRINTER BAUD RATE	LOCAL
PRINTER FORM FEED	COPY
PRINTER PORT	LOCAL
PRNTR PORT: HPIB	LOCAL
PRNTR PORT: PARALLEL	LOCAL
PRNTR PORT: SERIAL	LOCAL
PRNTR TYPE []	LOCAL
PWR LOSS on OFF	CAL
PWR RANGE AUTO man	CAL
PWRMTR CAL []	CAL
PWRMTR CAL [OFF]	CAL
R	MEAS
R+jX MKR	MARKER
RANGE 0 -15 TO +10	MENU
RANGE 1 -25 TO 0	MENU
RANGE 2 -35 TO -10	MENU
RANGE 3 -45 TO -20	MENU
RANGE 4 -55 TO -30	MENU
RANGE 5 -65 TO -40	MENU
RANGE 6 -75 TO -50	MENU
RANGE 7 -85 TO -60	MENU

Table 9-2. Softkey Locations (continued)

Softkey	Front-Panel Access Key
RAW ARRAY on OFF	SAVE/RECALL
RAW OFFSET ON Off	SYSTEM
Re/Im MKR	MARKER
REAL	FORMAT
RECALL CAL PORT 1	Cal
RECALL CAL PORT 2	Cal
RECALL CAL SETS	Cal
RECALL COLORS	DISPLAY
RECALL KEYS MENU	SAVE/RECALL
RECALL KEYS on OFF	SAVE/RECALL
RECALL REG1	SAVE/RECALL
RECALL REG2	SAVE/RECALL
RECALL REG3	SAVE/RECALL
RECALL REG4	SAVE/RECALL
RECALL REG5	SAVE/RECALL
RECALL REG6	SAVE/RECALL
RECALL REG7	SAVE/RECALL
RECALL STATE	SAVE/RECALL
RECEIVER CAL	CAL
REFERENCE POSITION	SCALE REF
REFERENCE VALUE	SCALE REF
REFL: FWD S11 (A/R)	MEAS
REFL: REV S22 (B/R)	MEAS
REFLECT AND LINE	CAL
REFLECTION	CAL
REMOVE ADAPTER	CAL
RENAME FILE	SAVE/RECALL
RE-SAVE STATE	SAVE/RECALL
RESET COLOR	DISPLAY
RESPONSE	CAL

Table 9-2. Softkey Locations (continued)

Softkey	Front-Panel Access Key
RESPONSE & ISOL'N	CAL
RESUME CAL SEQUENCE	CAL
REV ISOL'N ISOL'N STD	CAL
REV MATCH	CAL
REV MATCH THRU	CAL
REV TRANS	CAL
REV TRANS THRU	CAL
RF > LO	SYSTEM
RF < LO	SYSTEM
RIGHT LOWER	COPY
RIGHT UPPER	COPY
ROUND SECONDS	SYSTEM
S PARAMETERS	MEAS
S11 1-PORT	CAL
S11A	CAL
S11B	CAL
S11C	CAL
S11 REFL OPEN	CAL
S22 1-PORT	CAL
S22A	CAL
S22B	CAL
S22C	CAL
S22 REFL OPEN	CAL
SAMPLR COR ON off	SYSTEM
SAVE COLORS	DISPLAY
SAVE USER KIT	CAL
SAVE USING ASCII	SAVE/RECALL
SAVE USING BINARY	SAVE/RECALL

Table 9-2. Softkey Locations (continued)

Softkey	Front-Panel Access Key
SCALE/DIV	SCALE REF
SCALE PLOT []	COPY
SEARCH LEFT	MARKER FCTN
SEARCH RIGHT	MARKER FCTN
SEARCH: MAX	MARKER FCTN
SEARCH: MIN	MARKER FCTN
SEARCH: OFF	MARKER FCTN
SECOND	SYSTEM
SEGMENT	CAL
SEGMENT	SYSTEM
SEGMENT: CENTER	MENU
SEGMENT: SPAN	MENU
SEGMENT: START	MENU
SEGMENT: STOP	MENU
SEL QUAD []	COPY
SELECT DISK	SAVE/RECALL
SEQUENCE 1 SEQ1	SEQ
SEQUENCE 2 SEQ2	SEQ
SEQUENCE 3 SEQ3	SEQ
SEQUENCE 4 SEQ4	SEQ
SEQUENCE 5 SEQ5	SEQ
SEQUENCE 6 SEQ6	SEQ
SEQUENCE FILENAMING	Save/Recall
SET ADDRESSES	LOCAL
SET BIT	SEQ
SET CLOCK	SYSTEM
SET DAY	SYSTEM
SET FREQ LOW PASS	SYSTEM
SET HOUR	SYSTEM
SET MINUTES	SYSTEM
SET MONTH	SYSTEM
SET REF: THRU	SYSTEM
SET REF: REFLECT	SYSTEM

Table 9-2. Softkey Locations (continued)

Softkey	Front-Panel Access Key
SET YEAR	(SYSTEM)
SET ZO	(CAL)
SHORT	(CAL)
SINGLE	(MENU)
SINGLE POINT	(SYSTEM)
SINGLE SEG SWEEP	(MENU)
SLIDING	(CAL)
SLOPE	(MENU)
SLOPE on OFF	(MENU)
SLOPING LINE	(SYSTEM)
SMITH CHART	(FORMAT)
SMITH MKR MENU	(MARKER)
SMOOTHING APERTURE	(AVG)
SMOOTHING on OFF	(AVG)
SOURCE PWR ON off	(MENU)
SPAN	(MENU)
SPAN	(SYSTEM)
SPECIAL FUNCTIONS	(SEQ)
SPECIFY CLASS	(CAL)
SPECIFY GATE	(SYSTEM)
SPECIFY OFFSET	(CAL)
SPLIT DISP on OFF	(DISPLAY)
SPUR AVOID On Off	(SYSTEM)
STANDARDS DONE	(CAL)
STATS on OFF	(MARKER FCTN)
STD DONE (MODIFIED)	(CAL)
STD OFFSET DONE	(CAL)
STD TYPE:	(CAL)
STEP SIZE	(MENU)
STIMULUS VALUE	(SYSTEM)
STIMULUS OFFSET	(SYSTEM)
STORE SEQ TO DISK	(SEQ)

Table 9-2. Softkey Locations (continued)

Softkey	Front-Panel Access Key
SWEEP	(SYSTEM)
SWEEP TIME []	(MENU)
SWEEP TYPE MENU	(MENU)
SWR	(FORMAT)
SYSTEM CONTROLLER	(LOCAL)
TAKE CAL SWEEP	(CAL)
TAKE RCVR CAL SWEEP	(CAL)
TALKER/LISTENER	(LOCAL)
TARGET	(MARKER FCTN)
TERMINAL IMPEDANCE	(CAL)
TEST PORT 1 2	(MEAS)
TESTSET I/O FWD	(SEQ)
TESTSET I/O REV	(SEQ)
TESTSET SW XXXX	(Cal) (SYSTEM)
TEXT	(DISPLAY)
TEXT []	(COPY)
THRU	(CAL)
THRU THRU	(CAL)
TIME STAMP ON off	(SYSTEM)
TINT	(DISPLAY)
TITLE	(DISPLAY)
TITLE SEQUENCE	(SEQ)
TITLE TO MEMORY	(SEQ)

Table 9-2. Softkey Locations (continued)

Softkey	Front-Panel Access Key
TITLE TO P MTR/HPIB	(SEQ)
TITLE TO PERIPHERAL	(SEQ)
TITLE TO PRNTR/HPIB	(SEQ)
TRACKING on OFF	(MARKER FCTN)
TRANS DONE	(CAL)
TRANS: FWD S21 (B/R)	(MEAS)
TRANS: REV S12 (B/R)	(MEAS)
TRANSFORM MENU	(SYSTEM)
TRANSFORM on OFF	(SYSTEM)
TRANSMISSION	(CAL)
TRIGGER MENU	(MENU)
TRIGGER: TRIG OFF	(MENU)
TRL*/LRM* 2-PORT	(CAL)
TRL/LRM OPTION	(CAL)
TTL I/O	(SEQ)
TTL OUT HIGH	(SEQ)
TTL OUT LOW	(SEQ)
TUNED RECEIVER	(SYSTEM)
UNCOUPLED	(MARKER)
UP CONVERTER	(SYSTEM)
UPPER LIMIT	(SYSTEM)
USE MEMORY on OFF	(SYSTEM)
USE PASS CONTROL	(LOCAL)
USER	(PRESET)
USER KIT	(CAL)
USE SENSOR A / B	(CAL)
VELOCITY FACTOR	(CAL)
VIEW MEASURE	(SYSTEM)
VOLUME NUMBER	(LOCAL)
VOLUME NUMBER	(SAVE/RECALL)
WAIT x	(SEQ)
WARNING	(DISPLAY)

Table 9-2. Softkey Locations (continued)

Softkey	Front-Panel Access Key
WARNING []	(COPY)
WAVEGUIDE	(CAL)
WAVEGUIDE DELAY	(SCALE REF)
WIDE	(SYSTEM)
WIDTH VALUE	(MARKER FCTN)
WIDTHS on OFF	(MARKER FCTN)
WINDOW	(SYSTEM)
WINDOW: MAXIMUM	(SYSTEM)
WINDOW: MINIMUM	(SYSTEM)
WINDOW: NORMAL	(SYSTEM)
XMIT CNTRL []	(LOCAL)
Y: REFL	(MEAS)
Y: TRANS	(MEAS)
Z: REFL	(MEAS)
Z: TRANS	(MEAS)

Error Messages

This chapter contains the following information to help you interpret any error messages that may be displayed on the analyzer LCD or transmitted by the instrument over HP-IB:

- An alphabetical listing of all error messages, including:
 - An explanation of the message
 - Suggestions to help solve the problem
- A numerical listing of all error messages

Note Some messages described in this chapter are for information only and do not indicate an error condition. These messages are not numbered and so they will not appear in the numerical listing.

Where to Look for More Information

Additional information about many of the topics discussed in this chapter is located in the following areas:

- Chapter 2, “Making Measurements,” contains step-by-step procedures for making measurements or using particular functions.
- Chapter 4, “Printing, Plotting, and Saving Measurement Results,” contains instructions for saving to disk or the analyzer internal memory, and printing and plotting displayed measurements.
- Chapter 6, “Application and Operation Concepts,” contains explanatory-style information about many applications and analyzer operation.
- Chapter 9, “Key Definitions,” describes all the front panel keys, softkeys, and their corresponding HP-IB commands.
- Chapter 12, “Preset State and Memory Allocation,” contains a discussion of memory allocation, memory storage, instrument state definitions, and preset conditions.

Error Messages in Alphabetical Order

ABORTING COPY OUTPUT

Information Message This message is displayed briefly if you have pressed **LOCAL** to abort a copy operation. If the message is not subsequently replaced by error message number 25, PRINT ABORTED, the copy device may be hung. Press **LOCAL** once more to exit the abort process and verify the status of the copy device. At this point, the copy device will probably have an error condition which must be fixed. (For example: out of paper or paper jam.)

ADDITIONAL STANDARDS NEEDED

Error Number 68 Error correction for the selected calibration class cannot be computed until you have measured all the necessary standards.

ADDRESSED TO TALK WITH NOTHING TO SAY

Error Number 31 You have sent a read command to the analyzer (such as ENTER 716) without first requesting data with an appropriate output command (such as OUTPDATA). The analyzer has no data in the output queue to satisfy the request.

AIR FLOW RESTRICTED: CHECK FAN FILTER

Error Number 20 Something is restricting the air flow into the analyzer. Check for any debris and clean or replace the fan filter.

ALL REGISTERS HAVE BEEN USED

Error Number 200 You have used all of the available registers; you can store no more instrument states even though you may still have sufficient memory. There are 31 registers available, plus the present instrument state.

ANOTHER SYSTEM CONTROLLER ON HP-IB BUS

Error Number 37 You must remove the active controller from the bus or the controller must relinquish the bus before the analyzer can assume the system controller mode.

ASCII: MISSING 'BEGIN' STATEMENT

Error Number 193 The citifile you just downloaded over the HP-IB or via disk was not properly organized. The analyzer is unable to read the "BEGIN" statement.

ASCII: MISSING 'CITIFILE' STATEMENT

Error Number 194 The citifile you just downloaded over the HP-IB or via disk was not properly organized. The analyzer is unable to read the "CITIFILE" statement.

ASCII: MISSING 'DATA' STATEMENT

Error Number 195 The citifile you just downloaded over the HP-IB or via disk was not properly organized. The analyzer is unable to read the "DATA" statement.

ASCII: MISSING 'VAR' STATEMENT

Error Number 196 The citifile you just downloaded over the HP-IB or via disk was not properly organized. The analyzer is unable to read the "VAR" statement.

AVERAGING INVALID ON NON-RATIO MEASURE

Error Number 13 You cannot use sweep-to-sweep averaging in single-input measurements. Sweep-sweep averaging is valid only for ratioed measurements (A/R, B/R, A/B, and S-parameters). You can use noise reduction techniques, such as narrower IF bandwidth, for single input measurements.

BAD FREQ FOR HARMONIC OR FREQ OFFSET

Error Number 181 You turned on time domain or recalled a calibration that resulted in start and stop frequencies that are beyond the allowable limits.

BATTERY FAILED. STATE MEMORY CLEARED

Error Number 183 The battery protection of the non-volatile CMOS memory has failed. The CMOS memory has been cleared. Refer to the *HP 8753D Network Analyzer Service Guide* for battery replacement instructions. See Chapter 12, "Preset State and Memory Allocation," for more information about the CMOS memory.

BATTERY LOW! STORE SAVE REGS TO DISK

Error Number 184 The battery protection of the non-volatile CMOS memory is in danger of failing. If this occurs, all of the instrument state registers stored in CMOS memory will be lost. Save these states to a disk and refer to the *HP 8753D Network Analyzer Service Guide* for battery replacement instructions. See Chapter 12, "Preset State and Memory Allocation," for more information about the CMOS memory.

BLOCK INPUT ERROR

Error Number 34 The analyzer did not receive a complete data transmission. This is usually caused by an interruption of the bus transaction. Clear by pressing the **LOCAL** key or aborting the I/O process at the controller.

BLOCK INPUT LENGTH ERROR

Error Number 35 The length of the header received by the analyzer did not agree with the size of the internal array block. Refer to the *HP 8753D Network Analyzer Programmer's Guide* for instructions on using analyzer input commands.

CALIBRATION ABORTED

Error Number 74 You have changed the active channel during a calibration so the calibration in progress was terminated. Make sure the appropriate channel is active and restart the calibration.

CALIBRATION REQUIRED

Error Number 63 A calibration set could not be found that matched the current stimulus state or measurement parameter. You will have to perform a new calibration.

CANNOT FORMAT DOS DISKS ON THIS DRIVE

Error Number 185 You have attempted to initialize a floppy disk to DOS format on an external disk drive that does not support writing to all 80 tracks of the double density and high density disks. The older single-sided disks had only 66 tracks and some disk drives were limited to accessing that number of tracks. To format the disk, either choose another external disk drive or use the analyzer's internal disk drive.

CANNOT MODIFY FACTORY PRESET

Error Number 199 You have attempted to rename, delete, or otherwise alter the factory preset state. The factory preset state is permanently stored in CMOS memory and cannot be altered. If your intent was to create a user preset state, you must create a new instrument state, save it, and then rename it to "UPRESET". Refer to Chapter 12, "Preset State and Memory Allocation," for more detailed instructions.

CANNOT READ/WRITE HFS FILE SYSTEM

Error Number 203 The disk is being accessed by the analyzer and is found to contain an HFS (hierarchical file system) or files nested within subdirectories. The analyzer does not support HFS. Replace the disk medium with a LIF or DOS formatted disk that does not contain files nested within subdirectories.

CAN'T STORE/LOAD SEQUENCE, INSUFFICIENT MEMORY

Error Number 127 Your sequence transfer to or from a disk could not be completed due to insufficient memory.

CH1 (CH2) TARGET VALUE NOT FOUND

Error Number 159 Your target value for the marker search function does not exist on the current data trace.

CONTINUOUS SWITCHING NOT ALLOWED

Error Number 10 Your current measurement requires different power ranges on channel 1 and channel 2. To protect the attenuator from undue mechanical wear, test set hold will be activated.

The "tsH" (test set hold) indicator in the left margin of the display indicates that the inactive channel has been put in the sweep hold mode.

COPY: device not responding; copy aborted

Error Number 170 The printer or plotter is not accepting data. Verify the cable connections, HP-IB addresses, and otherwise ensure that the copy device is ready.

COPY OUTPUT COMPLETED

Information The analyzer has completed outputting data to the printer or plotter. The
Message analyzer can now accept another copy command.

CORRECTION AND DOMAIN RESET

Error Number 65 When you change the frequency range, sweep type, or number of points, error-correction is switched off and the time domain transform is recalculated, without error-correction. You can either correct the frequency range, sweep type, or number of points to match the calibration, or perform a new calibration. Then perform a new time domain transform.

CORRECTION CONSTANTS NOT STORED

Error Number 3 A store operation to the EEPROM was not successful. You must change the position of the jumper on the A9 CPU assembly. Refer to the “A9 CC Jumper Position Procedure” in the “Adjustments and Correction Constants” chapter of the *HP 8753D Network Analyzer Service Guide*.

CORRECTION TURNED OFF

Error Number 66 Critical parameters in your current instrument state do not match the parameters for the calibration set, therefore correction has been turned off. The critical instrument state parameters are sweep type, start frequency, frequency span, and number of points.

CURRENT PARAMETER NOT IN CAL SET

Error Number 64 Correction is not valid for your selected measurement parameter. Either change the measurement parameters or perform a new calibration.

D2/D1 INVALID WITH SINGLE CHANNEL

Error Number 130 You can only make a D2/D1 measurement if both channels are on.

D2/D1 INVALID: CH1 CH2 NUM PTS DIFFERENT

Error Number 152 You can only make a D2/D1 measurement if both channels have the same number of points.

DEADLOCK

Error Number 111 A fatal firmware error occurred before instrument preset completed. Call your local Hewlett-Packard sales and service office.

DEMODULATION NOT VALID

Error Number 17 Demodulation was selected when the analyzer was not in CW time mode. Select demodulation only after putting the analyzer into CW time mode.

DEVICE: not on, not connect, wrong addr

Error Number 119 The device at the selected address cannot be accessed by the analyzer. Verify that the device is switched on, and check the HP-IB connection between the analyzer and the device. Ensure that the device address recognized by the analyzer matches the HP-IB address set on the device itself.

DIRECTORY FULL

Error Number 188 There is no room left in the directory to add files. Either delete files or get a new disk.

DISK HARDWARE PROBLEM

Error Number 39 The disk drive is not responding correctly. Refer to the *HP 8753D Network Analyzer Service Guide* for troubleshooting information. If using an external disk drive, refer to the disk drive operating manual.

DISK IS WRITE PROTECTED

Error Number 48 The store operation cannot write to a write-protected disk. Slide the write-protect tab over the write-protect opening in order to write data on the disk.

DISK MEDIUM NOT INITIALIZED

Error Number 40 You must initialize the disk before it can be used.

DISK MESSAGE LENGTH ERROR

Error Number 190 The analyzer and the external disk drive aren't communicating properly. Check the HP-IB connection and then try substituting another disk drive to isolate the problem instrument.

DISK: not on, not connected, wrong addr

Error Number 38 The disk cannot be accessed by the analyzer. Verify power to the disk drive, and check the HP-IB connection between the analyzer and the disk drive. Ensure that the disk drive address recognized by the analyzer matches the HP-IB address set on the disk drive itself.

DISK READ/WRITE ERROR

Error Number 189 There may be a problem with your disk. Try a new floppy disk. If a new floppy disk does not eliminate the error, suspect hardware problems.

DISK WEAR - REPLACE DISK SOON

Error Number 49 Cumulative use of the disk is approaching the maximum. Copy files as necessary using an external controller. If no controller is available, load instrument states from the old disk and store them to a newly initialized disk using the save/recall features of the analyzer. Discard the old disk.

DOMAIN RESET

Error Number 67 Time domain calculations were reset due to a change in the frequency range, sweep type, or number of points. Perform a new time domain transform on the new state.

DOS NAME LIMITED TO 8 CHARS + 3 CHAR EXTENSION

Error Number A DOS file name must meet the following criteria:

- 180
- minimum of 1 character
 - format is filename.ext
 - maximum of 8 characters in the filename
 - maximum of 3 characters in the extension field (optional)
 - a dot separates the filename from the extension field (the dot is not part of the name on the disk)

DUPLICATING TO THIS SEQUENCE NOT ALLOWED

Error Number A sequence cannot be duplicated to itself.

125

EXCEEDED 7 STANDARDS PER CLASS

Error Number When modifying calibration kits, you can define a maximum of seven standards
72 for any class.

EXTERNAL SOURCE MODE REQUIRES CW TIME

Error Number An external source can only be phase locked and measured in the CW time
148 sweep mode.

EXT SOURCE NOT READY FOR TRIGGER

Error Number There is a hardware problem with the HP 8625A external source. Verify the
191 connections between the analyzer and the external source. If the connections
are correct, refer to the source operating manual.

EXT SRC: NOT ON/CONNECTED OR WRONG ADDR

Error Number The analyzer is unable to communicate with the external source. Check the
162 connections and the HP-IB address on the source.

FILE NOT COMPATIBLE WITH INSTRUMENT

Information You cannot recall user graphics that had been saved on an earlier model of
Message analyzer with a monochrome display. These files cannot be used with the
 HP 8753D.

FILE NOT FOUND

Error Number The requested file was not found on the current disk medium.
 192

FILE NOT FOUND OR WRONG TYPE

Error Number During a resave operation, either the file was not found or the type of file was
 197 not an instrument state file.

FIRST CHARACTER MUST BE A LETTER

Error Number The first character of a disk file title or an internal save register title must be
 42 an alpha character.

FORMAT NOT VALID FOR MEASUREMENT

Error Number Conversion measurements (Z or Y reflection and transmission) are not valid
 75 with Smith chart and SWR formats.

FORMATTING DATA

Information The list information is being processed for a list data output to a copy device
Message and stored in the copy spool buffer. During this time, the analyzer's resources
 are dedicated to this task (which takes less than a few seconds).

FREQ OFFSET ONLY VALID IN NETWORK ANALYZER MODE

Error Number You can only make frequency offset measurements in the network analyzer
 140 mode.

FREQS CANNOT BE CHANGED, TOO MANY POINTS

Error Number 204 The number of points selected for setting the low pass transform frequencies is too high. Reduce the number of points so that the low pass criteria is met.

FUNCTION NOT AVAILABLE

Error Number 202 The function you requested over HP-IB is not available on the current instrument.

FUNCTION NOT VALID

Error Number 14 The function you requested is incompatible with the current instrument state.

FUNCTION NOT VALID DURING MOD SEQUENCE

Error Number 131 You cannot perform sequencing operations while a sequence is being modified.

FUNCTION NOT VALID FOR INTERNAL MEMORY

Error Number 201 The function you selected only works with disk files.

FUNCTION ONLY VALID DURING MOD SEQUENCE

Error Number 164 You can only use the **GOSUB SEQUENCE** capability when you are building a sequence. Attempting to use this softkey at any other time returns an error message and no action is taken.

HP 8753 SOURCE PARAMETERS CHANGED

Error Number 61 Some of the stimulus parameters of the instrument state have been changed, because you have turned correction on. A calibration set for the current measurement parameter was found and activated. The instrument state was updated to match the stimulus parameters of the calibration state.

This message also appears when you have turned on harmonic mode or frequency offset and the present frequency range cannot be used with one of these modes.

HPIB COPY IN PROGRESS, ABORT WITH LOCAL

Error Number 169 An HP-IB copy was already in progress when you requested the HP-IB for another function. To abort the first copy, press **LOCAL**, otherwise the HP-IB is unavailable until the first copy is completed.

ILLEGAL UNIT OR VOLUME NUMBER

Error Number 46 The disk unit or volume number set in the analyzer is not valid. Refer to the disk drive operating manual.

INIT DISK removes all data from disk

Information Message Continuing with the initialize operation will *destroy* any data currently on the disk.

INITIALIZATION FAILED

Error Number 47 The disk initialization failed, probably because the disk is damaged.

INSTRUMENT STATE MEMORY CLEARED

Error Number 56 All instrument state registers have been cleared from memory along with any saved calibration data, memory traces, and calibration kit definitions. Additionally, all user-settable selections (such as HP-IB addresses) are set to their defaults.

INSUFFICIENT MEMORY

Error Number 51 Your last front panel or HP-IB request could not be implemented due to insufficient memory space. In some cases, this is a fatal error from which you can escape only by presetting the instrument.

INSUFFICIENT MEMORY FOR PRINT/PLOT

Error Number 168 There is not enough memory available for the print or plot function. Increase the available memory by changing or eliminating a memory-intensive operation such as reducing the number of points in the sweep.

INSUFFICIENT MEMORY, PWR MTR CAL OFF

Error Number 154 There is not enough memory space for the power meter calibration array. Increase the available memory by clearing one or more save/recall registers, or by reducing the number of points.

INVALID KEY

Error Number 2 You pressed an undefined softkey.

LIST MODE OFF: INVALID WITH LO FREQ

Error Number 182 List mode has been turned off in the frequency offset mode because it is incompatible with your selected LO frequency.

LIST TABLE EMPTY

Error Number 9 The frequency list is empty. To implement list frequency mode, add segments to the list table.

LOG SWEEP REQUIRES 2 OCTAVE MINIMUM SPAN

Error Number 150 A logarithmic sweep is only valid if the stop frequency is greater than four times the start frequency. For frequency spans of less than two octaves, the sweep type automatically reverts to linear sweep.

LOW PASS: FREQ LIMITS CHANGED

Information Message The frequency domain data points must be harmonically related from dc to the stop frequency. That is, $stop = n \times start$, where $n = \text{number of points}$. If this condition is not true when a low pass mode (step or impulse) is selected and transform is turned on, the analyzer resets the start and stop frequencies. The stop frequency is set close to the entered stop frequency, and the start frequency is set equal to $stop/n$.

MEMORY FOR CURRENT SEQUENCE IS FULL

Error Number 132 All the memory in the sequence you are modifying is filled with instrument commands.

MORE SLIDES NEEDED

Error Number 71 When you use a sliding load (in a user-defined calibration kit), you must set at least three slide positions to complete the calibration.

NO CALIBRATION CURRENTLY IN PROGRESS

Error Number 69 The **RESUME CAL SEQUENCE** softkey is not valid unless a calibration is already in progress. Start a new calibration.

NO DISK MEDIUM IN DRIVE

Error Number 41 You have no disk in the current disk unit. Insert a disk, or check the disk unit number stored in the analyzer.

NO FAIL FOUND

Service Error Number 114 The self-diagnose function of the instrument operates on an internal test failure. At this time, no failure has been detected.

NO FILE(S) FOUND ON DISK

Error Number 45 No files of the type created by an analyzer store operation were found on the disk or the disk drive is empty. If you requested a specific file title, that file was not found on the disk.

NO IF FOUND: CHECK R INPUT LEVEL

Error Number 5 The first IF signal was not detected during pretune. Check the front panel R channel jumper. If there is no visible problem with the jumper, refer to the *HP 8753D Network Analyzer Service Guide* for troubleshooting.

NO LIMIT LINES DISPLAYED

Error Number 144 You can turn limit lines on but they cannot be displayed on polar or Smith chart display formats.

NO MARKER DELTA -SPAN NOT SET

Error Number 15 You must turn the delta marker mode on, with at least two markers displayed, in order to use the **MARKER -> SPAN** softkey function.

NO MEMORY AVAILABLE FOR INTERPOLATION

Error Number 123 You cannot perform interpolated error correction due to insufficient memory.

NO MEMORY AVAILABLE FOR SEQUENCING

Error Number 126 You cannot modify the sequence due to insufficient memory.

NO PHASE LOCK: CHECK R INPUT LEVEL

Error Number 7 The first IF signal was detected at pretune, but phase lock could not be acquired. Check the signal level to the R channel input to make sure it is -35 dBm or higher. Refer to the *HP 8753D Network Analyzer Service Guide* for troubleshooting.

NO SPACE FOR NEW CAL. CLEAR REGISTERS

Error Number 70 You cannot store a calibration set due to insufficient memory. You can free more memory by clearing a saved instrument state from an internal register (which may also delete an associated calibration set, if all the instrument states using the calibration kit have been deleted). You can store the saved instrument state and calibration set to a disk before clearing them. After deleting the instrument states, press **PRESET** to run the memory packer.

NOT ALLOWED DURING POWER METER CAL

Error Number 198 When the analyzer is performing a power meter calibration, the HP-IB bus is unavailable for other functions such as printing or plotting.

NOT ENOUGH SPACE ON DISK FOR STORE

Error Number 44 The store operation will overflow the available disk space. Insert a new disk or purge files to create free disk space.

NO VALID MEMORY TRACE

Error Number 54 If you are going to display or otherwise use a memory trace, you must first store a data trace to memory.

NO VALID STATE IN REGISTER

Error Number 55 You have requested the analyzer, over HP-IB (or by sequencing), to load an instrument state from an *empty* internal register.

ONLY LETTERS AND NUMBERS ARE ALLOWED

Error Number 43 You can only use alpha-numeric characters (and underscores) in disk file titles or internal save register titles. Other symbols are not allowed, except for the “underscore” symbol.

OPTIONAL FUNCTION; NOT INSTALLED

Error Number 1 The function you requested requires a capability provided by an option to the standard analyzer. That option is not currently installed. (Refer to Chapter 1 for a description of the available options.)

OVERLOAD ON INPUT A, POWER REDUCED

Error Number 58 See error number 57.

OVERLOAD ON INPUT B, POWER REDUCED

Error Number 59 See error number 57.

OVERLOAD ON INPUT R, POWER REDUCED

Error Number 57 You have exceeded approximately +14 dBm at one of the test ports. The RF output power is automatically reduced to –85 dBm. The annotation P↓ appears in the left margin of the display to indicate that the power trip function has been activated. When this occurs, reset the power to a lower level, then toggle the `SOURCE PWR on OFF` softkey to switch on the power again.

PARALLEL PORT NOT AVAILABLE FOR GPIO

Error Number 165 You have defined the parallel port as COPY for sequencing in the HP-IB menu. To access the parallel port for general purpose I/O (GPIO), set the selection to [GPIO].

PARALLEL PORT NOT AVAILABLE FOR COPY

Error Number 167 You have defined the parallel port as general purpose I/O (GPIO) for sequencing. The definition was made under the **LOCAL** key menus. To access the parallel port for copy, set the selection to **PARALLEL [COPY]**.

PHASE LOCK CAL FAILED

Error Number 4 An internal phase lock calibration routine is automatically executed at power-on, preset, and any time a loss of phase lock is detected. This message indicates that phase lock calibration was initiated and the first IF detected, but a problem prevented the calibration from completing successfully. Refer to the *HP 8753D Network Analyzer Service Guide* and execute pretune correction test 48.

This message may appear if you connect a mixer between the RF output and R input before turning on frequency offset mode. Ignore it: it will go away when you turn on frequency offset. This message may also appear if you turn on frequency offset mode before you define the offset.

PHASE LOCK LOST

Error Number 8 Phase lock was acquired but then lost. Refer to the *HP 8753D Network Analyzer Service Guide* for troubleshooting information.

PLOT ABORTED

Error Number 27 When you press the **LOCAL** key, the analyzer aborts the plot in progress.

PLOTTER: not on, not connect, wrong addr

Error Number 26 The plotter does not respond to control. Verify power to the plotter, and check the HP-IB connection between the analyzer and the plotter. Ensure that the plotter address recognized by the analyzer matches the HP-IB address set on the plotter itself.

PLOTTER NOT READY-PINCH WHEELS UP

Error Number 28 The plotter pinch wheels clamp the paper in place. If you raise the pinch wheels, the plotter indicates a “not ready” status on the bus.

POSSIBLE FALSE LOCK

Error Number 6 Phase lock has been achieved, but the source may be phase locked to the wrong harmonic of the synthesizer. Perform the source pretune correction routine documented in the “Adjustments and Correction Constants” chapter in the *HP 8753D Network Analyzer Service Guide*.

POWER METER INVALID

Error Number 116 The power meter indicates an out-of-range condition. Check the test setup.

POWER METER NOT SETTLED

Error Number 118 Sequential power meter readings are not consistent. Verify that the equipment is set up correctly. If so, preset the instrument and restart the operation.

POWER SUPPLY HOT!

Error Number 21 The temperature sensors on the A8 post-regulator assembly have detected an over-temperature condition. The power supplies regulated on the post-regulator have been shut down.

POWER SUPPLY SHUT DOWN!

Error Number 22 One or more supplies on the A8 post-regulator assembly have been shut down due to an over-current, over-voltage, or under-voltage condition.

POWER UNLEVELED

Error Number 179 There is either a hardware failure in the source or you have attempted to set the power level too high. The analyzer allows the output power to be set higher or lower than the specified available power range. However, these output powers may be unlevelled or unavailable. Check to see if the power level you set is within specifications. If it is, refer to the *HP 8753D Network Analyzer Service Guide* for troubleshooting.

PRESS [MENU] , SELECT CW (IF) FREQ , THEN SWEPT LO

Error Number When you are sweeping the RF and LO, the IF must be fixed.
161

PRINT ABORTED

Error Number When you press the **LOCAL** key, the analyzer aborts output to the printer.
25

print color not supported with EPSON

Error Number You have defined the printer type as EPSON-P2. Color print is not supported
178 with this printer. The print will abort.

PRINTER: busy

Error Number The parallel port printer is not accepting data.
176

PRINTER: error

Error Number The parallel port printer is malfunctioning. The analyzer cannot complete the
175 copy function.

PRINTER: not connected

Error Number There is no printer connected to the parallel port.
173

PRINTER: not handshaking

Error Number The printer at the parallel port is not responding.
177

PRINTER: not on line

Error Number The printer at the parallel port is not set on line.
172

PRINTER: not on, not connected, wrong addr

Error Number 24 The printer does not respond to control. Verify power to the printer, and check the HP-IB connection between the analyzer and the printer. Ensure that the printer address recognized by the analyzer matches the HP-IB address set on the printer itself.

PRINTER: paper error

Error Number 171 There is a paper-related problem with the parallel port printer such as a paper jam or out-of-paper condition.

PRINTER: power off

Error Number 174 The power to the printer at the parallel port is off.

PRINT/PLOT IN PROGRESS, ABORT WITH LOCAL

Error Number 166 If a print or plot is in progress and you attempt a second print or plot, this message is displayed and the second attempt is ignored. To abort a print or plot in progress, press **LOCAL**.

PROBE POWER SHUT DOWN!

Error Number 23 One or both of the probe power supplies have been shut down due to an over-current, over-voltage, or under-voltage condition.

PROCESSING DISPLAY LIST

Information Message The display information is being processed for a screen print to a copy device and stored in the copy spool buffer. During this time, the analyzer's resources are dedicated to this task (which takes less than a few seconds).

PWR MTR NOT ON/CONNECTED OR WRONG ADDR

Error Number 117 The power meter cannot be accessed by the analyzer. Verify that the power meter address and model number set in the analyzer match the address and model number of the actual power meter.

REQUESTED DATA NOT CURRENTLY AVAILABLE

Error Number 30 The analyzer does not currently contain the data you have requested. For example, this condition occurs when you request error term arrays and no calibration is active.

SAVE FAILED. INSUFFICIENT MEMORY

Error Number 151 You cannot store an instrument state in an internal register due to insufficient memory. Increase the available memory by clearing one or more save/recall registers and pressing **PRESET**, or by storing files to a disk.

SELECTED SEQUENCE IS EMPTY

Error Number 124 The sequence you attempted to run does not contain instrument commands.

SELF TEST #n FAILED

Service Error Number 112 Internal test #n has failed. Several internal test routines are executed at instrument preset. The analyzer reports the first failure detected. Refer to the *HP 8753D Network Analyzer Service Guide* for troubleshooting information on internal tests and the self-diagnose feature.

SEQUENCE ABORTED

Error Number 157 The sequence running was stopped prematurely when you pressed the **LOCAL** key.

SEQUENCE MAY HAVE CHANGED, CAN'T CONTINUE

Error Number 153 When you pause a sequence, you cannot continue it if you have modified it. You must start the sequence again.

SLIDES ABORTED (MEMORY REALLOCATION)

Error Number 73 You cannot perform sliding load measurements due to insufficient memory. Increase the available memory by clearing one or more save/recall registers and pressing **PRESET**, or by storing files to a disk.

SOURCE POWER TURNED OFF, RESET UNDER POWER MENU

Information Message You have exceeded the maximum power level at one of the inputs and power has been automatically reduced. The annotation P↓ indicates that power trip has been activated. When this occurs, reset the power and then press **MENU** **POWER SOURCE PWR** on **OFF**, to switch on the power.

STARTING COPY SPOOLER

Information Message The analyzer is beginning to output data from the spool buffer to the copy device. The analyzer resumes normal operation; the data is being output to the copy device in the background.

STOP/CW FREQ + OFFSET MUST BE < 3 GHz

Error Number 141 The output frequency of the mixer cannot violate the minimum/maximum frequency of the analyzer.

SWEEP MODE CHANGED TO CW TIME SWEEP

Error Number 187 If you select external source auto or manual instrument mode and you do not also select CW mode, the analyzer is automatically switched to CW.

SWEEP TIME INCREASED

Error Number 11 You have made instrument changes that cause the analyzer sweep time to be automatically increased. Some parameter changes that cause an increase in sweep time are narrower IF bandwidth, an increase in the number of points, and a change in sweep type.

SWEEP TIME TOO FAST

Error Number 12 The fractional-N and digital IF circuits have lost synchronization. Refer to the *HP 8753D Network Analyzer Service Guide* for troubleshooting information.

SWEEP TRIGGER SET TO HOLD

Information Message The instrument is in a hold state and is no longer sweeping. To take a new sweep, press **MENU** **TRIGGER MENU** **SINGLE** or **CONTINUOUS**.

SYNTAX ERROR

Error Number 33 You have improperly formatted an HP-IB command. Refer to the *HP 8753D Network Analyzer Programmer's Guide* for proper command syntax.

SYST CTRL OR PASS CTRL IN LOCAL MENU

Error Number 36 The analyzer is in talker/listener mode. In this mode, the analyzer cannot control a peripheral device on the bus. Use the local menu to change to system controller or pass control mode.

TEST ABORTED

Error Number 113 You have prematurely stopped a service test.

THIS LIST FREQ INVALID IN HARM/3 GHZ RNG

Error Number 133 You have set frequencies in the list that are outside of the allowable frequency range for harmonic measurements, or are greater than 3 GHz on instruments without Option 006. Reduce the frequency range of the list.

TOO MANY NESTED SEQUENCES. SEQ ABORTED

Error Number 164 You can only nest sequences to a maximum level of six. The sequence will abort if you nest more than six.

TOO MANY SEGMENTS OR POINTS

Error Number 50 You can have a maximum of 30 segments or 1632 points in frequency list mode. In power meter calibrations, you can have a maximum of 12 segments for power sensor cal factors and power loss functions.

TRANSFORM, GATE NOT ALLOWED

Error Number 16 You can perform a time domain transformation only in linear and CW sweep types.

TROUBLE! CHECK SETUP AND START OVER

Service Error Number 115 Your equipment setup for the adjustment procedure in progress is not correct. Check the setup diagram and instructions *HP 8753D Network Analyzer Service Guide*. Start the procedure again.

WAITING FOR CLEAN SWEEP

Information Message In single sweep mode, the instrument ensures that all changes to the instrument state, if any, have been implemented before taking the sweep. The command that you have initiated is being processed and will not be complete until the new sweep is completed. An asterisk * is displayed in the left margin until a complete fresh sweep has been taken.

WAITING FOR DISK

Information Message This message is displayed between the start and finish of a read or write operation to a disk.

WAITING FOR HP-IB CONTROL

Information Message You have instructed the analyzer to use pass control (USEPASC). When you send the analyzer an instruction that requires active controller mode, the analyzer requests control of the bus and simultaneously displays this message. If the message remains, the system controller is not relinquishing the bus.

WRITE ATTEMPTED WITHOUT SELECTING INPUT TYPE

Error Number 32 You have sent the data header “#A” to the analyzer with no preceding input command (such as INPUDATA). The instrument recognized the header but did not know what type of data to receive. Refer to the *HP 8753D Network Analyzer Programmer’s Guide* for command syntax information.

WRONG DISK FORMAT, INITIALIZE DISK

Error Number 77 You have attempted to store, load, or read file titles, but your disk format does not conform to the Logical Interchange Format (LIF) or DOS format. You must initialize the disk before reading or writing to it.

Error Messages in Numerical Order

Refer to the alphabetical listing for explanations and suggestions for solving the problems.

Error Number	Error
1	OPTIONAL FUNCTION; NOT INSTALLED
2	INVALID KEY
3	CORRECTION CONSTANTS NOT STORED
4	PHASE LOCK CAL FAILED
5	NO IF FOUND: CHECK R INPUT LEVEL
6	POSSIBLE FALSE LOCK
7	NO PHASE LOCK: CHECK R INPUT LEVEL
8	PHASE LOCK LOST
9	LIST TABLE EMPTY
10	CONTINUOUS SWITCHING NOT ALLOWED
11	SWEEP TIME INCREASED
12	SWEEP TIME TOO FAST
13	AVERAGING INVALID ON NON-RATIO MEASURE
14	FUNCTION NOT VALID
15	NO MARKER DELTA - SPAN NOT SET
16	TRANSFORM, GATE NOT ALLOWED
17	DEMODULATION NOT VALID
18	not used
19	LIST TABLE EMPTY: occurs if user selects LIST sweep type but there is no list freq. table
20	AIR FLOW RESTRICTED: CHECK FAN FILTER
21	POWER SUPPLY HOT!
22	POWER SUPPLY SHUT DOWN!
23	PROBE POWER SHUT DOWN!
24	PRINTER: not on, not connect, wrong addr
25	PRINT ABORTED
26	PLOTTER: not on, not connect, wrong addr

Error Number	Error
27	PLOT ABORTED
28	PLOTTER NOT READY-PINCH WHEELS UP
30	REQUESTED DATA NOT CURRENTLY AVAILABLE
31	ADDRESSED TO TALK WITH NOTHING TO SAY
32	WRITE ATTEMPTED WITHOUT SELECTING INPUT TYPE
33	SYNTAX ERROR
34	BLOCK INPUT ERROR
35	BLOCK INPUT LENGTH ERROR
36	SYST CTRL OR PASS CTRL IN LOCAL MENU
37	ANOTHER SYSTEM CONTROLLER ON HP-IB BUS
38	DISK: not on, not connected, wrong addr
39	DISK HARDWARE PROBLEM
40	DISK MEDIUM NOT INITIALIZED
41	NO DISK MEDIUM IN DRIVE
42	FIRST CHARACTER MUST BE A LETTER
43	ONLY LETTERS AND NUMBERS ARE ALLOWED
44	NOT ENOUGH SPACE ON DISK FOR STORE
45	NO FILE(S) FOUND ON DISK
46	ILLEGAL UNIT OR VOLUME NUMBER
47	INITIALIZATION FAILED
48	DISK IS WRITE PROTECTED
49	DISK WEAR-REPLACE DISK SOON
50	TOO MANY SEGMENTS OR POINTS
51	INSUFFICIENT MEMORY
52	not used
54	NO VALID MEMORY TRACE
55	NO VALID STATE IN REGISTER
56	INSTRUMENT STATE MEMORY CLEARED

Error Number	Error
57	OVERLOAD ON INPUT R, POWER REDUCED
58	OVERLOAD ON INPUT A, POWER REDUCED
59	OVERLOAD ON INPUT B, POWER REDUCED
60	not used
61	HP 8753 SOURCE PARAMETERS CHANGED
63	CALIBRATION REQUIRED
64	CURRENT PARAMETER NOT IN CAL SET
65	CORRECTION AND DOMAIN RESET
66	CORRECTION TURNED OFF
67	DOMAIN RESET
68	ADDITIONAL STANDARDS NEEDED
69	NO CALIBRATION CURRENTLY IN PROGRESS
70	NO SPACE FOR NEW CAL. CLEAR REGISTERS
71	MORE SLIDES NEEDED
72	EXCEEDED 7 STANDARDS PER CLASS
73	SLIDES ABORTED (MEMORY REALLOCATION)
74	CALIBRATION ABORTED
75	FORMAT NOT VALID FOR MEASUREMENT
77	WRONG DISK FORMAT, INITIALIZE DISK
111	DEADLOCK
112	SELF TEST #n FAILED
113	TEST ABORTED
114	NO FAIL FOUND
115	TROUBLE! CHECK SETUP AND START OVER
116	POWER METER INVALID
117	PWR MTR: NOT ON/CONNECTED OR WRONG ADDR
118	POWER METER NOT SETTLED
119	DEVICE: not on, not connect, wrong addr
123	NO MEMORY AVAILABLE FOR INTERPOLATION
124	SELECTED SEQUENCE IS EMPTY

Error Number	Error
125	DUPLICATING TO THIS SEQUENCE NOT ALLOWED
126	NO MEMORY AVAILABLE FOR SEQUENCING
127	CAN'T STORE/LOAD SEQUENCE, INSUFFICIENT MEMORY
130	D2/D1 INVALID WITH SINGLE CHANNEL
131	FUNCTION NOT VALID DURING MOD SEQUENCE
132	MEMORY FOR CURRENT SEQUENCE IS FULL
133	THIS LIST FREQ INVALID IN HARM/3 GHZ RNG
140	FREQ OFFSET ONLY VALID IN NETWORK ANALYZER MODE
141	STOP/CW FREQ + OFFSET MUST BE < 3 GHz
144	NO LIMIT LINES DISPLAYED
145	not used
148	EXTERNAL SOURCE MODE REQUIRES CW TIME
150	LOG SWEEP REQUIRES 2 OCTAVE MINIMUM SPAN
151	SAVE FAILED / INSUFFICIENT MEMORY
152	D2/D1 INVALID: CH1 CH2 NUM PTS DIFFERENT
153	SEQUENCE MAY HAVE CHANGED, CAN'T CONTINUE
154	INSUFFICIENT MEMORY, PWR MTR CAL OFF
157	SEQUENCE ABORTED
159	CH1 (CH2) TARGET VALUE NOT FOUND
161	PRESS [MENU], SELECT CW (IF) FREQ, THEN SWEPT LO
162	EXT SRC: NOT ON/CONNECTED OR WRONG ADDR
163	FUNCTION ONLY VALID DURING MOD SEQUENCE
164	TOO MANY NESTED SEQUENCES. SEQ ABORTED
165	PARALLEL PORT NOT AVAILABLE FOR GPIO
166	PRINT/PLOT IN PROGRESS, ABORT WITH LOCAL
167	PARALLEL PORT NOT AVAILABLE FOR COPY
168	INSUFFICIENT MEMORY FOR PRINT/PLOT
169	HPIB COPY IN PROGRESS, ABORT WITH LOCAL
170	COPY:device not responding; copy aborted

Error Number	Error
171	PRINTER: paper error
172	PRINTER: not on line
173	PRINTER: not connected
174	PRINTER: power off
175	PRINTER: error
176	PRINTER: busy
177	PRINTER: not handshaking
178	print color not supported with EPSON
179	POWER UNLEVELED
180	DOS NAME LIMITED TO 8 CHARS + 3 CHAR EXTENSION
181	BAD FREQ FOR HARMONIC OR FREQ OFFSET
182	LIST MODE OFF: INVALID WITH LO FREQ
183	BATTERY FAILED. STATE MEMORY CLEARED
184	BATTERY LOW! STORE SAVE REGS TO DISK
185	CANNOT FORMAT DOS DISKS ON THIS DRIVE
187	SWEEP MODE CHANGED TO CW TIME SWEEP
188	DIRECTORY FULL
189	DISK READ/WRITE ERROR
190	DISK MESSAGE LENGTH ERROR
191	EXT SOURCE NOT READY FOR TRIGGER
192	FILE NOT FOUND
193	ASCII: MISSING 'BEGIN' statement
194	ASCII: MISSING 'CITIFILE' statement
195	ASCII: MISSING 'DATA' statement
196	ASCII: MISSING 'VAR' statement

Error Number	Error
197	FILE NOT FOUND OR WRONG TYPE
198	NOT ALLOWED DURING POWER METER CAL
199	CANNOT MODIFY FACTORY PRESET
200	ALL REGISTERS HAVE BEEN USED
201	FUNCTION NOT VALID FOR INTERNAL MEMORY
202	FUNCTION NOT AVAILABLE
203	CANNOT READ/WRITE HFS FILE SYSTEM
204	FREQS CANNOT BE CHANGED, TOO MANY POINTS

Compatible Peripherals

This chapter contains the following information:

- Measurement accessories available
- System accessories available
- Connecting and configuring peripherals
- HP-IB programming overview

Where to Look for More Information

Additional information about many of the topics discussed in this chapter is located in the following areas:

- Chapter 2, “Making Measurements,” contains step-by-step procedures for making measurements or using particular functions.
- Chapter 6, “Application and Operation Concepts,” contains explanatory-style information about many applications and analyzer operation.

Measurement Accessories Available

Calibration Kits

The following calibration kits contain precision standards and required adapters of the indicated connector type. The standards (known devices) facilitate measurement calibration, also called vector error correction. Refer to the data sheet and ordering guide for additional information. Parts numbers for the standards are in their manuals.

- HP 85031B 7 mm Calibration Kit
- HP 85032B 50 Ohm Type-N Calibration Kit
- HP 85033D 3.5 mm Calibration Kit
- HP 85033C 3.5 mm Calibration Kit
- HP 85036B 75 Ohm Type-N Calibration Kit
- HP 85039A 75 Ohm Type-F Calibration Kit

Note The HP 85033D is the recommended 3.5 mm calibration kit as it provides greater measurement accuracy than the HP 85033C and it is easier to use due to one-piece opens.

Verification Kit

Accurate operation of the analyzer system can be verified by measuring known devices other than the standards used in calibration, and comparing the results with recorded data.

HP 85029B 7 mm Verification Kit

This kit contains traceable precision 7 mm devices used to confirm the system's error-corrected measurement uncertainty performance. Also included is verification data on a 3.5 inch disk, together with a hard-copy listing. A system verification procedure is provided with this kit and also in the *HP 8753D Service Guide*.

Test Port Return Cables

The following RF cables are used to connect a two-port device between the test ports. These cables provide shielding for high dynamic range measurements.

HP 11857D 7 mm Test Port Return Cable Set

This set consists of a pair of test port return cables that can be used in measurements of 7 mm devices. They can also be used with connectors other than 7 mm by using the appropriate precision adapters.

HP 11857B 75 Ohm Type-N Test Port Return Cable Set

This set consists of test port return cables for use with the HP 8753D Option 075.

Adapter Kits

HP 11852B 50 to 75 Ohm Minimum Loss Pad.

This device converts impedance from 50 ohms to 75 ohms or from 75 ohms to 50 ohms. It is used to provide a low SWR impedance match between a 75 ohm device under test and the HP 8753D network analyzer (without Option 075).

These adapter kits contain the connection hardware required for making measurements on devices of the indicated connector type.

- HP 11853A 50 Ohm Type-N Adapter Kit
- HP 11854A 50 Ohm BNC Adapter Kit
- HP 11855A 75 Ohm Type-N Adapter Kit
- HP 11856A 75 Ohm BNC Adapter Kit

Transistor Test Fixtures

The following Hewlett-Packard transistor test fixtures are compatible with the HP 8753D. Additional test fixtures for transistors and other devices are available from Inter-Continental Microwave. To order their catalog, request HP literature number 5091-4254E. Or contact Inter-Continental Microwave as follows:

1515 Wyatt Drive
Santa Clara, CA 95054-1524
(tel) 408 727-1596
(fax) 408 727-0105

HP 11600B and 11602B Transistor Fixtures.

These fixtures are used to hold devices for S-parameter measurements in a 50 ohm coaxial circuit. They can be used to measure bipolar or field-effect transistors in several configurations, from dc to 2.0 GHz. The HP 11600B accepts transistors with TO-18 to TO-72 package dimensions, and the HP 11602B accepts transistors with TO-5 to TO-12 package dimensions. Both fixtures can also be used to measure other circuit elements such as diodes, resistors, or inductors, which have 0.016 to 0.019 inch diameter leads.

HP 11608A Option 003 Transistor Fixture.

This fixture is designed to be user-milled to hold stripline transistors for S-parameter measurements. Option 003 is pre-milled for 0.205 inch diameter disc packages, such as the HP HPAC-200.

HP 11858A Transistor Fixture Adapter.

This adapter provides a rigid RF cable interconnection between the HP 8753D test port connectors and the HP 11600B, 11602B, or 11608A transistor fixture.

System Accessories Available

System Cabinet

The HP 85043D system cabinet is designed to rack mount the analyzer in a system configuration. The 132 cm (52 in) system cabinet includes a bookcase, a drawer, and a convenient work surface.

System Testmobile

The HP 1181A system testmobile is designed to provide mobility for instruments, test systems, and work stations. This system testmobile can hold units up to 610-mm (24 in) deep and has a load capacity of up to 90 kg (200 lb) on the tilt tray and 227 kg (500 lb) total.

Plotters and Printers

The analyzer is capable of plotting or printing displayed measurement results directly (without the use of an external computer) to a compatible peripheral. The analyzer supports HP-IB, serial, and parallel peripherals. Most Hewlett-Packard desktop printers and plotters are compatible with the analyzer. Some common compatible peripherals are listed here (some are no longer available for purchase but are listed here for your reference):

These plotters are compatible:

- HP 7440A ColorPro Eight-Pen Color Graphics Plotter
- HP 7470A Two-Pen Graphics Plotter
- HP 7475A Six-Pen Graphics Plotter
- HP 7550A/B High-Speed Eight-Pen Graphics Plotter

These printers are compatible:

- HP C2621A, DeskJet Portable 310
- HP C2634A, DeskJet Portable 320
- HP C2655A, DeskJet Portable 340
- HP C2642A, DeskJet 400
- HP C2106A, DeskJet 500
- HP C2114A, DeskJet 500C
- HP C2170A, DeskJet 520
- HP C2162A, DeskJet 540
- HP C2121A, DeskJet 550C
- HP C2168A, DeskJet 560C
- HP C2184A, DeskJet 600
- HP C2164A, DeskJet 660C
- HP C4567A, DeskJet 682C
- HP C4562A, DeskJet 690C
- HP C2145A, DeskJet 850C

- HP C1676A, DeskJet 1200C (can also be used to plot)
- HP C3540A, DeskJet 1600C (can also be used to plot)
- All LaserJets (can also be used to plot)
- HP 2227B QuietJet
- HP 2225A ThinkJet
- HP 3630A PaintJet Color Graphics Printer

Epson printers which are compatible with the Epson ESC/P2 printer control language, such as the LQ570, are also supported by the analyzer. Older Epson printers, however, such as the FX-80, will not work with the analyzer.

Mass Storage

The analyzer has the capability of storing instrument states directly to its internal memory, to an internal disk drive, or to an external disk drive. The internal 3.5 inch floppy disk can be initialized in both LIF and DOS formats and is capable of reading and writing data in both formats. Using the internal disk drive is the preferred method, but the capability to use external disk drives still exists. Most external disks using CS80 protocol are compatible.

Note The analyzer does not support the LIF-1 (hierarchy file system) directory format.

Caution Do not use the older single-sided disks in the analyzer's internal drive.

HP-IB Cables

An HP-IB cable is required for interfacing the analyzer with a plotter, printer, external disk drive, or computer. The cables available are:

- HP 10833A HP-IB Cable, 1.0 m (3.3 ft.)
- HP 10833B HP-IB Cable, 2.0 m (6.6 ft.)
- HP 10833D HP-IB Cable, 0.5 m (1.6 ft.)

Interface Cables

- HP C2912B Centronics (Parallel) Interface Cable, 3.0 m (9.9 ft.)
- HP C2913A RS-232C Interface Cable, 1.2 m (3.9 ft.)
- HP C2914A Serial Interface Cable, 1.2 m (3.9 ft.)
- HP 24542G Serial Interface Cable, 3 m (9.9 ft.)
- HP 24542D Parallel Interface Cable, 2 m (6 ft.)
- HP 92284A Parallel Interface Cable, 2 m (6 ft.)

Keyboards

A keyboard can be connected to the analyzer for data input such as titling files.

A keyboard can be connected to the analyzer for data input such as titling files. The HP C1405A Option ABA keyboard with the HP part number C1405-60015 adapter is suitable for this purpose. Or, the analyzer is designed to accept most PC-AT-compatible keyboards with a standard DIN connector. Keyboards with a mini-DIN connector are compatible with the HP part number C1405-60015 adapter.

Controller

An external controller is not required for measurement calibration or time domain capability. However, some performance test procedures are semi-automated and require the use of an external controller. (The system verification procedure does not require an external controller.) The system can be automated with the following computers:

- IBM PC compatible computer with an HP-IB/GP-IB interface card
- HP 9000 series 200/300 workstation
- HP 9000 series 700 workstation with HP BASIC-UX

For more information about compatible computers, call your nearest Hewlett-Packard Sales and Service office.

Sample Software

A set of sample measurement programs is provided with the *HP 8753D Network Analyzer Programmer's Guide* on a 3.5 inch disk. The programs include typical measurements to be used as an introductory example for programming the analyzer over HP-IB. It is designed to be easily modified for use in developing programs for specific needs. The programs are compatible with HP BASIC versions 2.0 and later, QuickBasic, and QuickC, and will run on an IBM PC compatible computer (as well as the HP 9000 series 200/300/700 workstations), using any HP 8753D compatible printer or plotter.

The following additional software products are also available for the HP 8753D:

- HP 85190A IC-CAP Modelling Suite
- Touchstone
- (MDS) HP Microwave Design System
- EEsof Series-IV

External Monitors

The analyzer can drive both its internal display and an external monitor simultaneously. One recommended color monitor is the HP 35741A/B.

External Monitor Requirements:

- 60 Hz vertical refresh rate
- 25.5 kHz horizontal refresh rate
- RGB with synchronization on green
- 75 ohm video input impedance
- video amplitude 1 V_{p-p} (0.7 V = white, 0 V = black, -0.3 V = synchronization)

Connecting Peripherals

Connecting the Peripheral Device

Connect the peripheral to the corresponding interface port.

Printer Interface	Recommended Cable
Parallel	HP 92284A
Serial	HP 24542G
HP-IB	HP 10833A/B/D

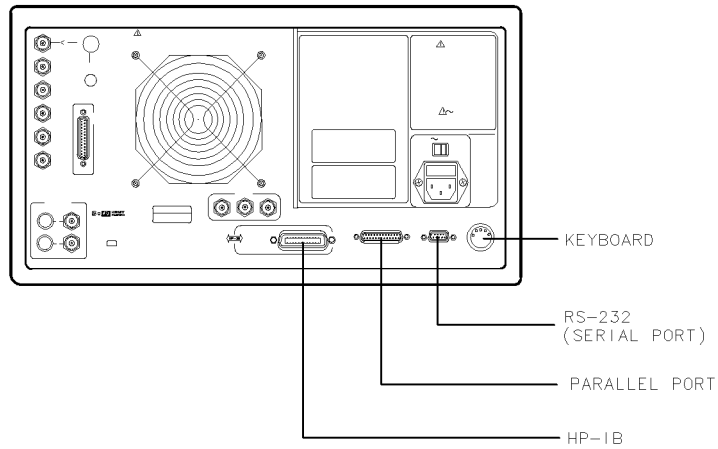

qq612d

Figure 11-1. Peripheral Connections to the Analyzer

Note The keyboard can be connected to the analyzer while the power is on or off.

Configuring the Analyzer for the Peripheral

All copy configuration settings are stored in non-volatile memory. Therefore, they are not affected if you press **PRESET** or switch off the analyzer power.

If the Peripheral is a Printer

1. Press **LOCAL** **SET ADDRESSES** **PRINTER PORT** **PRNTR TYPE** until the correct printer choice appears:
 - ThinkJet** (QuietJet)
 - DeskJet** (except for HP DeskJet 540 and DeskJet 850C)
 - LaserJet**
 - PaintJet**
 - Epson-P2** (printers that conform to the ESC/P2 printer control language)
 - DJ 540** (for use with the HP DeskJet 540 and DeskJet 850C)

Note Selecting **DJ 540** converts 100 dpi raster information to 300 dpi raster format. If your DeskJet printer does not support the 100 dpi raster format and your printing results seem to be less than normal size, select **DJ 540**.

2. Select one of the following printer interfaces:
 - Choose **PRNTR PORT HP-IB** if your printer has an HP-IB interface, and then configure the print function as follows:
 - a. Enter the HP-IB address of the printer, followed by **(x1)**.
 - b. Press **LOCAL** and **SYSTEM CONTROLLER** if there is no external controller connected to the HP-IB bus.
 - c. Press **LOCAL** and **USE PASS CONTROL** if there is an external controller connected to the HP-IB bus.
 - Choose **PARALLEL** if your printer has a parallel (centronics) interface, and then configure the print function as follows:
 - Press **LOCAL** and then select the parallel port interface function by pressing **PARALLEL** until the correct function appears:
 - If you choose **PARALLEL [COPY]**, the parallel port is dedicated for normal copy device use (printers or plotters).
 - If you choose **PARALLEL [GPIO]**, the parallel port is dedicated for general purpose I/O, and cannot be used for printing or plotting.

- Choose **SERIAL** if your printer has a serial (RS-232) interface, and then configure the print function as follows:
 - a. Press **PRINTER BAUD RATE** and enter the printer's baud rate, followed by **(x1)**.
 - b. To select the transmission control method that is compatible with your printer, press **XMIT CNTRL** (transmit control - handshaking protocol) until the correct method appears:
 - If you choose **Xon-Xoff**, the handshake method allows the printer to control the data exchange by transmitting control characters to the network analyzer.
 - If you choose **DTR-DSR**, the handshake method allows the printer to control the data exchange by setting the electrical voltage on one line of the RS-232 serial cable.

Note Because the **DTR-DSR** handshake takes place in the hardware rather than the firmware or software, it is the fastest transmission control method.

If the Peripheral is a Plotter

HPGL/2 Compatible Printer (used as a plotter)

1. Press **(LOCAL)** **SET ADDRESSES** **PRINTER PORT** and then press **PRNTR TYPE** until the correct printer choice appears:
 - **ThinkJet** (QuietJet)
 - **DeskJet** (only DeskJet 1200C and DeskJet 1600C)
 - **LaserJet** (only LaserJet III and IV)
 - **PaintJet**
 - **Epson-P2** (printers that conform to the ESC/P2 printer control language)
2. Configure the analyzer for one of the following printer interfaces:
 - Choose **PRNTR PORT HP-IB** if your printer has an HP-IB interface, and then configure the print function as follows:
 - a. Enter the HP-IB address of the printer (default is 01), followed by **(x1)**.
 - b. Press **(LOCAL)** and **SYSTEM CONTROLLER** if there is no external controller connected to the HP-IB bus.
 - c. Press **(LOCAL)** and **USE PASS CONTROL** if there is an external controller connected to the HP-IB bus.

- Choose **PARALLEL** if your printer has a parallel (centronics) interface, and then configure the print function as follows:
 - Press **LOCAL** and then select the parallel port interface function by pressing **PARALLEL** until the correct function appears:
 - If you choose **PARALLEL [COPY]**, the parallel port is dedicated for normal copy device use (printers or plotters).
 - If you choose **PARALLEL [GPIO]**, the parallel port is dedicated for general purpose I/O, and cannot be used for printing or plotting.
- Choose **SERIAL** if your printer has a serial (RS-232) interface, and then configure the print function as follows:
 - a. Press **PRINTER BAUD RATE** and enter the printer's baud rate, followed by **[x1]**.
 - b. To select the transmission control method that is compatible with your printer, press **XMIT CNTRL** (transmit control - handshaking protocol) until the correct method appears:
 - If you choose **Xon-Xoff**, the handshake method allows the printer to control the data exchange by transmitting control characters to the network analyzer.
 - If you choose **DTR-DSR**, the handshake method allows the printer to control the data exchange by setting the electrical voltage on one line of the RS-232 serial cable.

Note Because the **DTR-DSR** handshake takes place in the hardware rather than the firmware or software, it is the fastest transmission control method.

3. Press **LOCAL SET ADDRESSES PLOTTER PORT** and then **PLTR TYPE** until **PLTR TYPE [HPGL PRT]** appears.

Pen Plotter

1. Press **(LOCAL)** **SET ADDRESSES PLOTTER PORT** and then **PLTR TYPE** until **PLTR TYPE [PLOTTER]** appears.
2. Configure the analyzer for one of the following plotter interfaces:
 - Choose **PLTR PORT HP-IB** if your plotter has an HP-IB interface, and then configure the plot function as follows:
 - a. Enter the HP-IB address of the printer (default is 05), followed by **(x1)**.
 - b. Press **(LOCAL)** and **SYSTEM CONTROLLER** if there is no external controller connected to the HP-IB bus.
 - c. Press **(LOCAL)** and **USE PASS CONTROL** if there is an external controller connected to the HP-IB bus.
 - Choose **PARALLEL** if your printer has a parallel (centronics) interface, and then configure the print function as follows:
 - Press **(LOCAL)** and then select the parallel port interface function by pressing **PARALLEL** until the correct function appears:
 - If you choose **PARALLEL [COPY]**, the parallel port is dedicated for normal copy device use (printers or plotters).
 - If you choose **PARALLEL [GPIO]**, the parallel port is dedicated for general purpose I/O, and cannot be used for printing or plotting.
 - Choose **SERIAL** if your printer has a serial (RS-232) interface, and then configure the print function as follows:
 - a. Press **PRINTER BAUD RATE** and enter the printer's baud rate, followed by **(x1)**.
 - b. To select the transmission control method that is compatible with your printer, press **XMIT CNTRL** (transmit control - handshaking protocol) until the correct method appears:
 - If you choose **Xon-Xoff**, the handshake method allows the printer to control the data exchange by transmitting control characters to the network analyzer.
 - If you choose **DTR-DSR**, the handshake method allows the printer to control the data exchange by setting the electrical voltage on one line of the RS-232 serial cable.

Note Because the **DTR-DSR** handshake takes place in the hardware rather than the firmware or software, it is the fastest transmission control method.

If the Peripheral is a Power Meter

1. Press **LOCAL** **SET ADDRESSES**.
2. Press **POWER MTR: []** until the correct selection appears:
 - HP 436A
 - HP 437B or 438A
3. Press **ADDRESS: P MTR/HP-IB** and configure the power meter as follows:
 - a. Enter the HP-IB address of the power meter, followed by **(x1)**.
 - b. Press **LOCAL** and **SYSTEM CONTROLLER** if there is no external controller connected to the HP-IB bus.
 - c. Press **LOCAL** and **USE PASS CONTROL** if there is an external controller connected to the HP-IB bus.

If the Peripheral is an External Disk Drive

1. Press **LOCAL** **DISK UNIT NUMBER** and enter the drive where your disk is located, followed by **(x1)**.
2. If your storage disk is partitioned, press **VOLUME NUMBER** and enter the volume number where you want to store the instrument state file.
3. Press **SET ADDRESSES** **ADDRESS: DISK**.
4. Press **LOCAL** and select one of the following:
 - Choose **SYSTEM CONTROLLER** if there is no external controller connected.
 - Choose **PASS CONTROL** when an external controller is connected and the analyzer needs to control peripherals directly. This mode causes the analyzer to request control from the external controller whenever it needs to communicate with a peripheral.

If the Peripheral is a Computer Controller

1. Press **LOCAL** **SET ADDRESSES** **ADDRESS: CONTROLLER**.
2. Press **LOCAL** and select one of the following:
 - Choose **TALKER/LISTENER** to allow the computer controller to be involved in all peripheral access operations.
 - Choose **PASS CONTROL** when an external controller is connected and the analyzer needs to control peripherals directly. This mode causes the analyzer to request control from the external controller whenever it needs to communicate with a peripheral.

Configuring the Analyzer to Produce a Time Stamp

You can set a clock, and then activate it, if you want the time and date to appear on your hardcopies.

1. Press **(SYSTEM) SET CLOCK**.
2. Press **SET YEAR** and enter the current year, followed by **(x1)**.
3. Press **SET MONTH** and enter the current month of the year, followed **(x1)**.
4. Press **SET DAY** and enter the current day of the month, followed by **(x1)**.
5. Press **SET HOUR** and enter the current hour of the day (0-23), followed by **(x1)**.
6. Press **SET MINUTES** and enter the next immediate minute, followed by **(x1)**.
7. Press **ROUND SECONDS** when the current time is exactly as you have set it.
8. Press **TIME STAMP** until **TIME STAMP ON** appears on the softkey label.

HP-IB Programming Overview

The analyzer is factory-equipped with a remote programming digital interface using the Hewlett-Packard Interface Bus (HP-IB). HP-IB is Hewlett-Packard's hardware, software, documentation, and support for IEEE 488.1 and IEC-625, worldwide standards for interfacing instruments. The HP-IB lets you control the analyzer with an external computer that sends commands or instructions to and receives data from the analyzer. This provides a remote operator with the same control of the instrument available to the local operator, except for control of the power line switch and some internal tests.

In addition, without the use of an external computer, the analyzer can use HP-IB to output measurement results directly to a compatible printer or plotter and to store data to an external disk drive. It can also control a power meter for power calibration and, through a subset of HP-GL (Hewlett-Packard Graphics Language), user graphics can be plotted on the analyzer display.

- For more complete information on programming the analyzer remotely over HP-IB, refer to the *HP 8753D Network Analyzer Programmer's Guide*.
- For a complete general description of the HP-IB, refer to the *Tutorial Description of the Hewlett-Packard Interface Bus*, HP publication 5952-0156 and to *Condensed Description of the Hewlett-Packard Interface Bus* (HP part number 59401-90030).
- For more information on the IEEE-488.1 standard, refer to *IEEE Standard Digital Interface for Programmable Instrumentation*, published by the Institute of Electrical and Electronics Engineers, Inc., 345 East 47th Street, New York, New York 10017.

HP-IB Operation

The Hewlett-Packard Interface Bus (HP-IB) is Hewlett-Packard's hardware, software, documentation, and support for IEEE 488.2 and IEC-625 worldwide standards for interfacing instruments. This interface allows you to operate the analyzer and peripherals in two methods:

- by an external system controller
- by the network analyzer in system-controller mode

Device Types

The HP-IB employs a party-line bus structure in which up to 15 devices can be connected on one contiguous bus. The interface consists of 16 signal lines and 8 ground lines within a shielded cable. With this cabling system, many different types of devices including instruments, computers, power meters, plotters, printers, and disk drives can be connected in parallel.

Every HP-IB device must be capable of performing one or more of the following interface functions:

Talker

A talker is a device capable of transmitting device-dependent data when addressed to talk. There can be only one active talker at any given time. Examples of this type of device include:

- power meters
- disk drives
- voltmeters
- counters
- tape readers

The network analyzer is a talker when it sends trace data or marker information over the bus.

Listener

A listener is a device capable of receiving device-dependent data over the interface when addressed to listen. There can be as many as 14 listeners connected to the interface at any given time. Examples of this type of device include:

- printers
- power supplies
- signal generators

The network analyzer is a listener when it is controlled over the bus by a system controller.

Controller

A controller is defined as a device capable of:

1. managing the operation of the bus
2. addressing talkers and listeners

There can be only one active controller on the interface at any time. Examples of controllers include desktop computers, minicomputers, workstations, and the network analyzer. In a multiple-controller system, active control can be passed between controllers, but there can only be one *system* controller connected to the interface. The system controller acts as the master and can regain active control at any time. The analyzer is an active controller when it plots, prints, or stores to an external disk drive in the pass-control mode. The analyzer is also a system controller when it is operating in the system-controller mode.

HP-IB Bus Structure

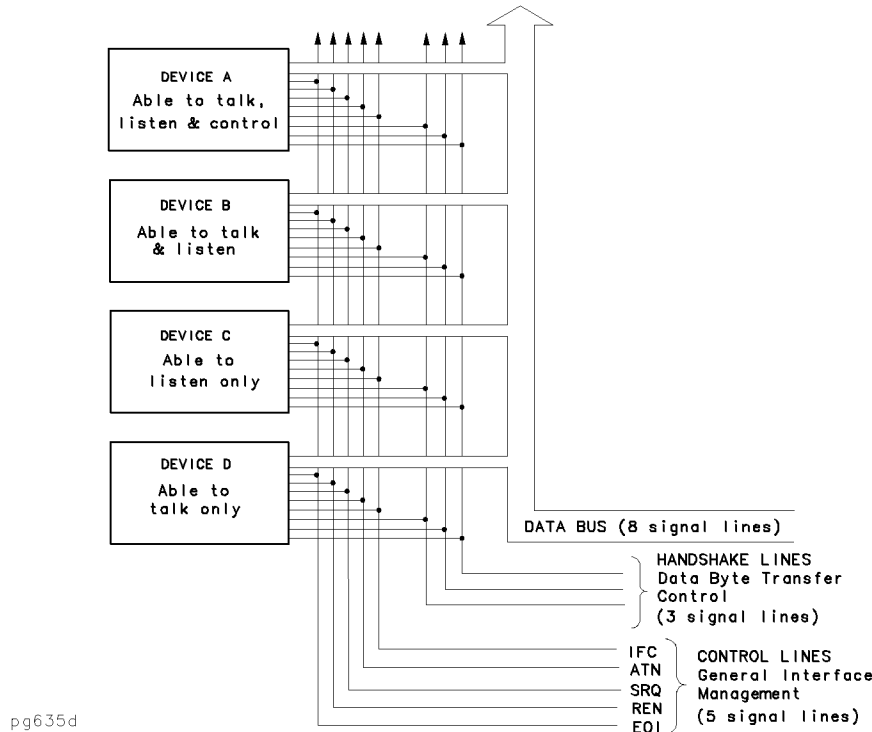

Figure 11-2. HP-IB Bus Structure

Data Bus

The data bus consists of 8 bi-directional lines that are used to transfer data from one device to another. Programming commands and data transmitted on these lines are typically encoded in ASCII, although binary encoding is often used to speed up the transfer of large arrays. Both ASCII- and binary-data formats are available to the analyzer. In addition, every byte transferred over HP-IB undergoes a handshake to insure valid data.

Handshake Lines

A three-line handshake scheme coordinates the transfer of data between talkers and listeners. To insure data integrity in multiple-listener transfers, this technique forces data transfers to occur at the transfer rate of the slowest device connected to the interface. With most computing controllers and instruments, the handshake is performed automatically, making it transparent to the programmer.

Control Lines

The data bus also has five control lines. The controller uses these lines to address devices and to send bus commands.

IFC (Interface Clear)

This line is used exclusively by the system controller. When this line is true (low), all devices (whether addressed or not) unaddress and revert to an idle state.

ATN (Attention)	The active controller uses this line to define whether the information on the data bus is command-oriented or data-oriented. When this line is true (low), the bus is in the command mode, and the data lines carry bus commands. When this line is false (high), the bus is in the data mode, and the data lines carry device-dependent instructions or data.
SRQ (Service Request)	This line is set true (low) when a device requests service and the active controller services the requesting device. The network analyzer can be enabled to pull the SRQ line for a variety of reasons such as requesting control of the interface, for the purposes of printing, plotting, or accessing a disk.
REN (Remote Enable)	This line is used exclusively by the system controller. When this line is set true (low), the bus is in the remote mode, and devices are addressed by the controller to either listen or talk. When the bus is in remote mode and a device is addressed, it receives instructions from the system controller via HP-IB rather than from its front panel (pressing LOCAL returns the device to front-panel operation). When this line is set false (high), the bus and all of the connected devices return to local operation.
EOI (End or Identify)	This line is used by a talker to indicate the last data byte in a multiple-byte transmission, or by an active controller to initiate a parallel-poll sequence. The analyzer recognizes the EOI line as a terminator, and it pulls the EOI line with the last byte of a message output (data, markers, plots, prints, error messages). The analyzer does not respond to parallel poll.

HP-IB Requirements

Number of Interconnected Devices:	15 maximum.
Interconnection Path Maximum Cable Length:	20 meters maximum or 2 meters per device (whichever is less).
Message Transfer Scheme:	Byte serial, bit parallel a synchronous data transfer using a 3-line handshake system.
Data Rate:	Maximum of 1 megabyte-per-second over the specified distances with tri-state drivers. Actual data rate depends on the transfer rate of the slowest device connected to the bus.
Address Capability:	Primary addresses: 31 talk, 31 listen. A maximum of 1 talker and 14 listeners can be connected to the interface at given time.
Multiple-Controller Capability:	In systems with more than one controller (like this instrument), only one controller can be active at any given time. The active controller can pass control to another controller, but only the system controller can assume unconditional control. Only one <i>system</i> controller is allowed.

HP-IB Operational Capabilities

On the network analyzer's rear panel, next to the HP-IB connector, there is a list of HP-IB device subsets as defined by the IEEE 488.2 standard. The analyzer has the following capabilities:

SH1	Full-source handshake.
AH1	Full-acceptor handshake.
T6	Basic talker, answers serial poll, unaddresses if MLA is issued. No talk-only mode.
L4	Basic listener, unaddresses if MTA is issued. No listen-only mode.
SR1	Complete service request (SRQ) capabilities.
RL1	Complete remote/local capability including local lockout.
PP0	Does not respond to parallel poll.
DC1	Complete device clear.
DT1	Responds to a Group Execute Trigger (GET) in the hold-trigger mode.
C1,C2,C3	System controller capabilities in system-controller mode.
C10	Pass control capabilities in pass-control mode.
E2	Tri-state drivers.
LE0	No extended listener capabilities.
TE0	No extended talker capabilities.

These codes are completely explained in the IEEE Std 488 documents, published by the Institute of Electrical and Electronic Engineers, Inc., 345 East 47th Street, New York, New York 11017.

HP-IB Status Indicators

When the analyzer is connected to other instruments over the HP-IB, the HP-IB status indicators illuminate to display the current status of the analyzer. The HP-IB status indicators are located in the instrument-state function block on the front panel of the network analyzer.

R = Remote Operation

L = Listen mode

T = Talk mode

S = Service request (SRQ) asserted by the analyzer

Bus Device Modes

The analyzer uses a single-bus architecture. The single bus allows both the analyzer and the host controller to have complete access to the peripherals in the system.

Three different controller modes are possible in an HP-IB system:

- system-controller mode
- talker/listener mode
- pass-control mode

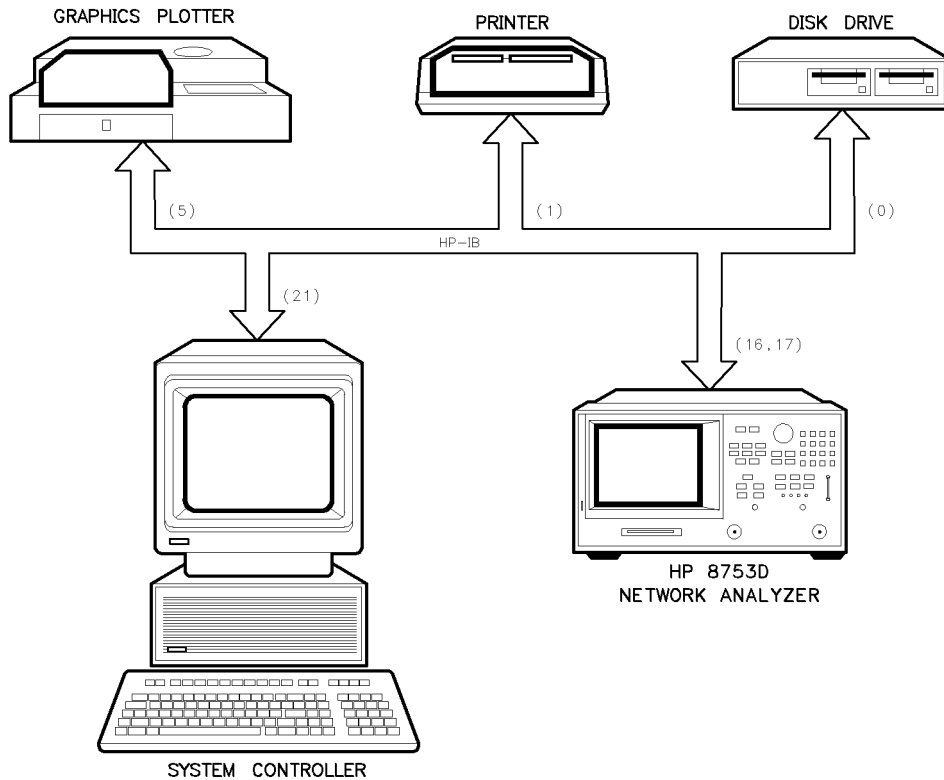

pg691d

Figure 11-3. Analyzer Single Bus Concept

System-Controller Mode

This mode allows the analyzer to control peripherals directly in a stand-alone environment (without an external controller). This mode can only be selected manually from the analyzer's front panel. It can only be used if no active computer or instrument controller is connected to the system via HP-IB. If an attempt is made to set the network analyzer to the system-controller mode when another controller is connected to the interface, the following message is displayed on the analyzer's display screen:

"ANOTHER SYSTEM CONTROLLER ON HP-IB BUS"

The analyzer must be set to the system-controller mode in order to access peripherals from the front panel. In this mode, the analyzer can directly control peripherals (plotters, printers, disk drives, power meters, etc.) and the analyzer may plot, print, store on disk or perform power meter functions.

Note Do not attempt to use this mode for programming. HP recommends using an external instrument controller when programming. See the following section, "Talker/Listener Mode."

Talker/Listener Mode

This is the mode that is normally used for remote programming of the analyzer. In talker/listener mode, the analyzer and all peripheral devices are controlled from an external instrument controller. The controller can command the analyzer to talk and other devices to listen. The analyzer and peripheral devices cannot talk directly to each other unless the computer sets up a data path between them. This mode allows the analyzer to act as either a talker or a listener, as required by the controlling computer for the particular operation in progress.

Pass-Control Mode

This mode allows the computer to control the analyzer via HP-IB (as with the talker/listener mode), but also allows the analyzer to take control of the interface in order to plot, print, or access a disk. During an analyzer-controlled peripheral operation, the host computer is free to perform other internal tasks (i.e. data or display manipulation) while the analyzer is controlling the bus. After the analyzer-controlled task is completed, the analyzer returns control to the system controller.

Setting HP-IB Addresses

In systems interfaced using HP-IB, each instrument on the bus is identified by an HP-IB address. This address code must be different for each instrument on the bus. These addresses are stored in short-term, non-volatile memory and are not affected when you press **PRESET** or cycle the power. The analyzer occupies two HP-IB addresses: the instrument itself and the display. The display address is derived from the instrument address by complementing the instrument's least-significant bit. Hence, if the instrument is at an even address, the display occupies the next higher address. If the instrument is at an odd address, the display occupies the next lower address.

The analyzer addresses are set by pressing **LOCAL SET ADDRESSES**. In system-controller mode, the addresses must be set for the plotter, printer, disk drive, and power meter.

The default address for the analyzer is device 16, and the display address is device 17.

Note There is also an address for the system controller. This address refers to the controller when the network analyzer is being used in pass-control mode. This is the address that control is passed back to when the analyzer-controlled operation is complete.

Analyzer Command Syntax

Code Naming Convention

The analyzer HP-IB commands are derived from their front-panel key titles (where possible), according to this naming convention:

Simple commands are the first four letters of the function they control, as in `POWE`, the command name for power. If the function label contains two words, the first three mnemonic letters are the first three letters of the first word, and the fourth mnemonic letter is the first letter of the second word. For example, `ELED` is derived from electrical delay.

If there are many commands grouped together in a category, as in markers or plotting pen numbers, the command is increased to 8 letters. The first 4 letters are the category label derived using rule 1. The last 4 letters are the function specifier, again derived using rule 1. As an example, category pen numbers are represented by the command `PENN`, which is used in combination with several functions such as `PENNDATA`, `PENNMEMO`.

The code naming guidelines, listed in Table 11-1, are used in order to:

- make commands more meaningful and easier to remember
- maintain compatibility with other products (including the HP 8510)

Note There are times when these guidelines are not followed due to technical considerations.

Table 11-1. Code Naming Convention

Convention	Key Title	For HP-IB Code Use	Example
One Word	Power Start	First Four Letters	POWE STAR
Two Words	Electrical Delay Search Right	First Three Letters of First Word, First Letter of Second Word	ELED SEAR
Two Words in a Group	Marker → Center Gate → Span	Four Letters of Both	MARKCENT GATESPAN
Three Words	Cal Kit N 50 Ω Pen Num Data	First Three Letters of First Word, First Letter of Second Word, First Four Letters of Third Word	CALKN50 PENNDATA

Some codes require appendages (ON, OFF, 1, 2, etc.). Codes that do not have a front-panel equivalent are HP-IB only commands. They use a similar convention based on the common name of the function.

Valid Characters

The analyzer accepts the following ASCII characters:

- letters
- numbers
- decimal points
- +/–
- semicolons (;)
- quotation marks (")
- carriage returns (CR)
- linefeeds (LF)

Both upper- and lower-case letters are acceptable. Carriage returns, leading zeros, spaces, and unnecessary terminators are ignored, except for those within a command or appendage. If the analyzer does not recognize a character as appropriate, it generates a syntax error message and recovers at the next terminator.

Units

The analyzer can input and output data in basic units such as Hz, dB, seconds, ohms, etc.

S	Seconds	HZ	Hertz
V	Volts	DB	dB or dBm

Input data is assumed to be in basic units unless one of the following units expressions qualifies the data input (upper and lower case are equivalent):

MS	Milliseconds	KHz	Kilohertz
US	Microseconds	MHz	Megahertz
NS	Nanoseconds	GHz	Gigahertz
PS	Picoseconds	FS	Femtoseconds

HP-IB Debug Mode

An HP-IB diagnostic feature (debug mode) is available in the HP-IB menu. Activating the debug mode causes the analyzer to scroll incoming HP-IB commands across the display. Nonprintable characters are represented with a π . Any time the analyzer receives a syntax error, the commands halt, and a pointer indicates the misunderstood character. See the *HP 8753D Network Analyzer Programmer's Guide* for information on correct programming syntax.

Preset State and Memory Allocation

The analyzer is capable of saving complete instrument states for later retrieval. It can store these instrument states into the internal memory, to the internal disk, or to an external disk. This chapter describes these capabilities in the following sections:

- instrument state definition
- memory allocation
- internal and external data storage
- description of analyzer state after preset

Where to Look for More Information

Additional information about many of the topics discussed in this chapter is located in the following areas:

- Chapter 2, “Making Measurements,” contains step-by-step procedures for making measurements or using particular functions.
- Chapter 4, “Printing, Plotting, and Saving Measurement Results,” contains instructions for saving to disk or the analyzer internal memory, and printing and plotting displayed measurements.

Types of Memory and Data Storage

The analyzer utilizes two types of memory and can also utilize the internal disk drive or be connected to an external disk drive:

Volatile Memory

This is dynamic read/write memory, of approximately 2 Mbytes, that contains all of the parameters that make up the *current* instrument state. An instrument state consists of all the stimulus and response parameters that set up the analyzer to make a specific measurement.

Some data that you may think is part of the instrument state (such as calibration data and memory traces) are actually stored in non-volatile memory. See “Non-Volatile Memory” to read more about the differences.

Volatile memory is cleared upon a power cycle of the instrument and, except as noted, upon instrument preset.

Non-Volatile Memory

This is CMOS read/write memory that is protected by a battery to provide storage of data when line power to the instrument is turned off. With this battery protection, data can be retained in memory for ≈ 250 days at 70 ° C and for ≈ 10 years at 25 ° C (characteristically).

Non-volatile memory consists of a block of user-allocated memory and a block of fixed memory.

The user-allocated memory is available for you to save the following data:

- instrument states
- measurement calibration data
- power meter calibration data
- user calibration kit definitions
- memory traces
- user preset

Note Even though calibration data is stored in non-volatile memory, if the associated instrument state is not saved, you will not be able to retrieve the calibration data after a power cycle.

The fixed memory is used to store the following data (you cannot change where this data is stored and it does not affect your memory availability for storing user-allocated data):

- HP-IB addresses
- copy configuration (printer and plotter type, port, baud rate, handshake)
- power meter type (HP 436/438)
- display colors
- sequence titles
- sixth sequence
- power sensor calibration factors and loss tables
- user-defined calibration kits
- system Z0
- factory preset
- HP-IB configuration
- display intensity default

The maximum number of instrument states, calibrations, and memory traces that can reside in non-volatile memory at any one time is limited to 31 instrument states, 128 calibrations (4 per instrument state, including the present instrument state), and 64 memory traces (2 per instrument state, including the present instrument state).

In addition, the number of instrument states and associated calibrations and memory traces are limited by the available memory. To display the amount of unused memory on the analyzer, press **(SAVE/RECALL)**. (Be sure you have selected **INTERNAL MEMORY** as your disk type.) In the upper right-hand portion of the display, the value displayed as **Bytes free:** is the unused non-volatile memory. When you save to the internal memory, you will see the number of bytes free decrease. When you delete files, the number of bytes free increases. There is a maximum of 512 kBytes available.

If you have deleted registers since the last time the instrument was preset, the bytes available for you to use may be less than the actual “bytes free” that is displayed. Deleting registers to increase the available memory will work in cases where the registers being deleted and the registers needing to be added are of the same standard size (such as instrument states not having calibrations associated with them). In certain other cases, however, you may have to press **(PRESET)** after deleting registers so that the “bytes free” value equals the available memory value. During a preset, the analyzer runs a memory packer that de-fragments the free memory into one contiguous block.

Table 12-1 shows the memory requirements of calibration arrays and memory trace arrays to help you approximate memory requirements. For example, add the following memory requirements:

- a full 2-port calibration with 801 points (58 k)
- the memory trace array (4.9 k)
- the instrument state (3 k)

The total memory requirement is 65.9 kbytes. There is sufficient memory to store 7 calibrations of this type. However, the same calibration performed with 1601 points and 2 channels uncoupled would require 252 k bytes:

- a full 2-port calibration with 1601 points, two channels, uncoupled (230 k)
- the memory trace array (19 k)
- the instrument state (3 k)

Only 2 of these calibrations could reside in memory before the available memory would be depleted.

**Table 12-1.
Memory Requirements of Calibration and Memory Trace Arrays**

Variable	Data Length (Bytes)	Approximate Totals (Bytes)			
		401 pts	801 pts	1601 pts	
		1 chan		1 chan	2 chans
Calibration Arrays					
Response	$N \times 6 + 52$	2.5 k	5 k	10 k	19 k
Response and isolation	$N \times 6 \times 2 + 52$	5 k	10 k	19 k	38 k
1-Port	$N \times 6 \times 3 + 52$	7 k	14 k	29 k	58 k
2-Port	$N \times 6 \times 12 + 52$	29 k	58 k	115 k	230 k
Interpolated cal	Same as above in addition to regular cal				
Power Meter Cal*	$(N^\dagger \times 2 \times \text{number of channels}^\ddagger) + 208$	1 k	1.8 k	3.4 k	6.6 k
Measurement Data					
Memory trace array*	$N \times 6 + 52$	2.5 k	4.9 k	9.7 k	19 k
Instrument State#		3 k	3 k	3 k	3 k
N = number of points * This variable is allocated once per active channel. † The number of points that was set at the time the cal was turned on. ‡ If the channels are coupled, this number is always 1. If the channels are uncoupled, this number refers to the number of channels that have power meter cal on. # This value may change with different firmware revisions.					

The analyzer attempts to allocate memory at the start of a calibration. If insufficient memory is available, an error message is displayed. It is possible that the CMOS memory might be fragmented due to the sequence of saving and deleting states of various sizes. So another alternative would be to store the current state to disk and then press **PRESET**. The analyzer runs a memory packer which might regain some previously inaccessible memory. If memory is still inadequate, delete an instrument state and restart the calibration.

Storing Data to Disk

You can use the internal disk drive or connect an external disk drive for storage of instrument states, calibration data, measurement data, and plot files. (Refer to Chapter 4, “Printing, Plotting, and Saving Measurement Results”, for more information on saving measurement data and plot files.)

The analyzer displays one file name per stored instrument state when you list the disk directory. In reality, several files are actually stored to the disk when you store the instrument state. Thus, when the disk directory is accessed from a remote system controller, the directory will show several files associated with a particular saved state. The maximum number of files that you can store on a disk depends on the directory size. You can define the directory size when you format a disk. See Table 12-3 for the default directory size for floppy disks and hard disks.

The maximum number of instrument states and calibrations that can reside on a disk is limited by the available disk space. To see the available disk space displayed on the analyzer, press **(SAVE/RECALL)**. (Be sure you have selected either **INTERNAL DISK** or **EXTERNAL DISK** depending on your disk type.) In the upper righthand portion of the display, the value displayed as **Bytes free:** is the available disk space. If your disk is formatted in LIF, this value is the largest contiguous block of disk space. Since the analyzer is reporting the largest contiguous block of disk space, you may or may not see the bytes free number change when you delete files. If your disk is formatted in DOS, the number reported as bytes free is the total available disk space. That number is updated whenever you save to or delete files from the disk.

A disk file created by the analyzer appends a suffix to the file name. (This is on the analyzer’s directory and is not visible.) The suffix consists of one or two characters: the first character is the file type and the second is a data index. (Refer to Table 12-2 for the definitions of each suffix character.)

Table 12-2. Suffix Character Definitions

Char 1	Definition	Char 2	Definition
I	Instrument state		
G	Graphics	1 0	Display graphics Graphics index
D	Error corrected data	1 2	Channel 1 Channel 2
R	Raw data	1 to 4 5 to 8	Channel 1, raw arrays 1 to 4 Channel 2, raw arrays 5 to 8
F	Formatted data	1 2	Channel 1 Channel 2
C	Cal	K	Cal kit
1	Cal data, channel 1	0 1 to 9 A B C	Stimulus state Coefficients 1 to 9 Coefficient 10 Coefficient 11 Coefficient 12
2	Cal data, channel 2	0 to C	same as channel 1
M	Memory trace data	1 2	Channel 1 Channel 2

If correction is on at the time of an external store, the calibration set is stored to disk. (Note that inactive calibrations are not stored to disk.) When an instrument state is loaded into the

analyzer from disk, the stimulus and response parameters are restored first. If correction is on for the loaded state, the analyzer will load a calibration set from disk that carries the same title as the one stored for the instrument state.

Conserving Memory

If you are concerned about conserving memory, either internal memory or external disk space, some of the most memory-intensive operations include:

- two-port error correction
- interpolated error correction
- 1601 measurement points
- using time domain
- saving data arrays and graphics with the instrument state

Using Saved Calibration Sets

When you are saving to internal memory (CMOS, non-volatile memory), calibration sets are linked to the instrument state and measurement parameter for which the calibration was done. Therefore a saved calibration can be used for multiple instrument states as long as the measurement parameter, frequency range, and number of points are the same. A full 2-port calibration is valid for any S-parameter measurement with the same frequency range and number of points. When an instrument state is deleted from memory, the associated calibration set is also deleted if it is unused by any other state.

The following hints will help you avoid potential problems:

- If a measurement is saved with calibration and interpolated calibration on, it will be restored with interpolated calibration on.
- A calibration stored from one instrument and recalled by a different one will be invalid. To ensure maximum accuracy, always recalibrate in these circumstances.
- No record is kept in memory of the temperature when a calibration set was stored. Instrument characteristics change as a function of temperature, and a calibration stored at one temperature may be inaccurate if recalled and used at a different temperature. See Chapter 7, “Specifications and Measurement Uncertainties,” for allowable temperature ranges for individual specifications.
- The HP 8753D can read disk files created by the HP 8753B/C and the HP 8753B/C can read files created by the HP 8753D. A disk file translator is available to make HP 8753A disk files compatible with HP 8753B files. These files can then be read by the HP 8753D. Contact your local Hewlett-Packard sales and service office for a copy of this disk file translator.

Preset State

When the **PRESET** key is pressed, the analyzer reverts to a known state called the factory preset state. This state is defined in Table 12-3. There are subtle differences between the preset state and the power-up state. These differences are documented in Table 12-4. If power to non-volatile memory is lost, the analyzer will have certain parameters set to default settings. Table 12-5 shows the affected parameters.

When line power is cycled, or the **PRESET** key pressed, the analyzer performs a self-test routine. Upon successful completion of that routine, the instrument state is set to the conditions shown in Table 12-3. The same conditions are true following a “PRES;” or “RST;” command over HP-IB, although the self-test routines are not executed.

You also can configure an instrument state and define it as your user preset state:

1. Set the instrument state to your desired preset conditions.
2. Save the state (save/recall menu).
3. Rename that register to “UPRESET”.
4. Press **PRESET** **PRESET:USER**.

The **PRESET** key is now toggled to the **USER** selection and your defined instrument state will be recalled each time you press **PRESET** and when you turn power on. You can toggle back to the factory preset instrument state by pressing **PRESET** and selecting **FACTORY**.

Note When you send a preset over HP-IB, you will always get the factory preset. You can, however, activate the user-defined preset over HP-IB by recalling the register in which it is stored.

Table 12-3. Preset Conditions (1 of 5)

Preset Conditions	Preset Value	Preset Conditions	Preset Value
Analyzer Mode		Frequency List	
Analyzer Mode	Network Analyzer Mode	Frequency List	Empty
Frequency Offset	Off	Edit Mode	Start/Stop, Number of Points
Operation			
Offset Value	0	Response Conditions	
Harmonic Operation	Off	Parameter	Channel 1: S11; Channel 2: S21
Stimulus Conditions		Conversion	Off
Sweep Type	Linear Frequency	Format	Log Magnitude (all inputs)
Display Mode	Start/Stop	Display	Data
Trigger Type	Continuous	Color Selections	Same as before PRESET
External Trigger	Off	Dual Channel	Off
Sweep Time	100 ms, Auto Mode	Active Channel	Channel 1
Start Frequency	30 kHz	Frequency Blank	Disabled
Frequency Span (1.)	2999.97 MHz	Split Display	On
Frequency Span (Opt. 006)	5999.97 MHz	Intensity	If set to $\geq 15\%$, PRESET has no effect. If set to $< 15\%$ PRESET increases intensity to 15%.
Start Time	0	Beeper: Done	On
Time Span	100 ms	Beeper: Warning	Off
CW Frequency	1000 MHz	D2/D1 to D2	Off
Source Power	0 dBm	Title	Channel 1 = [hp] Channel 2 = Empty
Power Slope	0 dB/GHz; Off	IF Bandwidth	3000 Hz
Start Power	-15.0 dBm	IF Averaging Factor	16; Off
Power Span	25 dB	Smoothing Aperture	1% SPAN; Off
Coupled Power	On	Phase Offset	0 Degrees
Source Power	On	Electrical Delay	0 ns
Coupled Channels	On	Scale/Division	10 dB/Division
Coupled Port Power	On		
Power Range	Auto; Range 0		
Number of Points	201		

Table 12-3. Preset Conditions (2 of 5)

Preset Conditions	Preset Value	Preset Conditions	Preset Value
Calibration		Marker Statistics	Off
Correction	Off	Polar Marker	Lin Mkr
Calibration Type	None	Smith Marker	R + jX Mkr
Calibration Kit	7 mm		
System Z0	50 Ohms		
Velocity Factor	1	Limit Lines	
Extensions	Off	Limit Lines	Off
Port 1	0 s	Limit Testing	Off
Port 2	0 s	Limit List	Empty
Input A	0 s	Edit Mode	Upper/Lower Limits
Input B	0 s	Stimulus Offset	0 Hz
Chop A and B	On	Amplitude Offset	0 dB
Power Meter Calibration	Off	Limit Type	Sloping Line
Number of Readings	1	Beep Fail	Off
Power Loss Correction	Off		
Sensor A/B	A	Time Domain	
Interpolated Error	Off	Transform	Off
Correction		Transform Type	Bandpass
Markers (coupled)		Start Transform	-20 nanoseconds
Markers 1, 2, 3, 4, 5	1 GHz; All Markers Off	Transform Span	40 nanoseconds
Last Active Marker	1	Gating	Off
Reference Marker	None	Gate Shape	Normal
Marker Mode	Continuous	Gate Start	-10 nanoseconds
Display Markers	On	Gate Span	20 nanoseconds
Delta Marker Mode	Off	Demodulation	Off
Coupling	On	Window	Normal
Marker Search	Off	Use Memory	Off
Marker Target Value	-3 dB		
Marker Width Value	-3 dB; Off	System Parameters	
Marker Tracking	Off	HP-IB Addresses	Last Active State
Marker Stimulus Offset	0 Hz	HP-IB Mode	Last Active State
Marker Value Offset	0 dB	Focus	Last Active State
Marker Aux Offset (Phase)	0 Degrees	Clock Time Stamp	On
		Preset: Factory/User	Last Selected State

Table 12-3. Preset Conditions (3 of 5)

Preset Conditions	Preset Value	Preset Conditions	Preset Value
Copy Configuration		Sampler Correction	On
Parallel Port	Last Active State	Spur Avoidance	On
Plotter Type	Last Active State	Aux Input Resolution	Low
Plotter Port	Last Active State	Analog Bus Node	11 (Aux Input)
Plotter Baud Rate	Last Active State		
Plotter Handshake	Last Active State	Plot	
HP-IB Address	Last Active State	Plot Data	On
Printer Type	Last Active State	Plot Memory	On
Printer Port	Last Active State	Plot Graticule	On
Printer Baud Rate	Last Active State	Plot Text	On
Printer Handshake	Last Active State	Plot Marker	On
Printer HP-IB Address	Last Active State	Autofeed	On
		Plot Quadrant	Full Page
Disk Save Configuration		Scale Plot	Full
(Define Store)		Plot Speed	Fast
Data Array	Off	Pen Number:	
Raw Data Array	Off	Ch1 Data	2
Formatted Data Array	Off	Ch2 Data	3
Graphics	Off	Ch1 Memory	5
Data Only	Off	Ch2 Memory	6
Directory Size	Default ¹	Ch1 Graticule	1
Save Using	Binary	Ch2 Graticule	1
Select Disk	Internal Memory	Ch1 Text	7
Disk Format	LIF	Ch2 Text	7
		Ch1 Marker	7
Sequencing²		Ch2 Marker	7
Loop Counter	0	Line Type:	
TTL OUT	High	Ch1 Data	7
		Ch2 Data	7
Service Modes		Ch1 Memory	7
HP-IB Diagnostic	Off	Ch2 Memory	7
Source Phase Lock	Loop On		

1 The directory size is calculated as 0.013% of the floppy disk size (which is ≈ 256) or 0.005% of the hard disk size.

2 Pressing preset turns off sequencing modify (edit) mode and stops any running sequence.

Table 12-3. Preset Conditions (4 of 5)

Preset Conditions	Preset Value	Preset Conditions	Preset Value
Print		CH2 Data	Blue
Printer Mode	Last Active State	CH2 Mem	Red
Auto-Feed	On	Graticule	Cyan
Printer Colors		Warning	Black
CH1 Data	Magenta	Text	Black
CH1 Mem	Green		

Table 12-3. Preset Conditions (5 of 5)

Format Table	Scale	Reference	
		Position	Value
Log Magnitude (dB)	10.0	5.0	0.0
Phase (degree)	90.0	5.0	0.0
Group Delay (ns)	10.0	5.0	0.0
Smith Chart	1.00	-	1.0
Polar	1.00	-	1.0
Linear Magnitude	0.1	0.0	0.0
Real	0.2	5.0	0.0
Imaginary	0.2	5.0	0.0
SWR	1.00	0.0	1.0

Table 12-4. Power-on Conditions (versus Preset)

HP-IB MODE	Talker/listener.
SAVE REGISTERS	Power meter calibration data and calibration data not associated with an instrument state are cleared.
COLOR DISPLAY	Default color values.
INTENSITY	Factory stored values. The factory values can be changed by running the appropriate service routine. Refer to the "Adjustments and Correction Constants" chapter in the <i>HP 8753D Service Guide</i> .
SEQUENCES	Sequence 1 through 5 are erased.
DISK DIRECTORY	Cleared.

Table 12-5. Results of Power Loss to Non-Volatile Memory

HP-IB ADDRESSES are set to the following defaults:	
HP 8753D	16
USER DISPLAY	17
PLOTTER.....	5
PRINTER.....	1
POWER METER.....	13
DISK.....	0
DISK UNIT NUMBER.....	0
DISK VOLUME NUMBER	0
POWER METER TYPE is set to HP 438A/437	
INTERNAL REGISTER TITLES ¹ are set to defaults: REG1 through REG32	
EXTERNAL REGISTER TITLES ¹ (store files) are set to defaults: FILE1 through FILE 5	
PRINT TYPE is set to default: MONOCHROME	
PRINTING/PLOTTING SETUPS are set to the following defaults:	
PARALLEL PORT	COPY
PLOTTER TYPE.....	PLOTTER
PLOTTER PORT.....	SERIAL
PLOTTER BAUD RATE.....	9600
PLOTTER HANDSHAKE.....	Xon-Xoff
PRINTER TYPE.....	DESKJET
PRINTER PORT.....	PARALLEL
PRINTER BAUD RATE	19200
PRINTER HANDSHAKE	Xon-Xoff

1 Only applies to HP-IB operation.

The CITIfile Data Format and Keyword Reference

This appendix contains the following information:

- The CITIfile Data Format
 - Description and Overview
 - Definition Of CITIfile Terms
 - CITIfile Examples
- The CITIfile Keyword Reference.

The CITIfile Data Format

Description and Overview

CITIfile is a standardized data format, used for exchanging data between different computers and instruments. CITIfile is an abbreviation for “Common Instrumentation Transfer and Interchange file”. This standard has been a group effort between instrument designers and designers of computer-aided design programs. As much as possible, CITIfile meets current needs for data transfer, and it was designed to be expandable so it can meet future needs.

CITIfile defines how the data inside an ASCII package is formatted. Since it is not tied to any particular disk or transfer format, it can be used with any operating system (BASIC, DOS, UNIX, etc.), with any disk format (LIF, DOS, 1, etc.), or with any transfer mechanism (disk, LAN, GPIB, etc.).

By careful implementation of the standard, instruments and software packages using CITIfile are able to load and work with data created on another instrument or computer. It is possible, for example, for a network analyzer to directly load and display data measured on a scalar analyzer, or for a software package running on a computer to read data measured on the network analyzer.

Data Formats

There are two main types of data formats: binary and ASCII. CITIfile uses the ASCII text format. While this format does take up more bytes of space than a binary format, ASCII data is a transportable, standard type of format which is supported by all operating systems. In addition, the ASCII format is accepted by most text editors. This allows files to be created, examined, and edited easily, making CITIfile easier to test and debug.

File and Operating System Formats

CITIfile was designed to be independent of the data storage mechanism, and therefore may be implemented for any file system. However transfer between file systems may sometimes be necessary. Any commercially available software that has the ability to transfer ASCII files between systems may be used to transfer CITIfile data.

Definition of CITIfile Terms

This section will define the following terms:

- package
- header
- data array
- keyword

A CITIfile Package

A typical package is divided into two parts: The first part, the header, is made up of keywords and setup information. The second part, the data, usually consists of one or more arrays of data. Example 1 shows the basic structure of a CITIfile package:

Example 1, A CITIfile Package

The “header” part	CITIFILE A.01.00 NAME MEMORY VAR FREQ MAG 3 DATA S RI
The “data” part	BEGIN -3.54545E-2,-1.38601E-3 0.23491E-3,-1.39883E-3 2.00382E-3,-1.40022E-3 END

When stored in a disk file there may be more than one CITIfile package. With the 8510 network analyzer, for example, storing a “memory all” will save all eight of the memories held in the instrument. This results in a single file which contains eight CITIfile packages.

The CITIfile Header

The header section contains information about the data that will follow. It may also include information about the setup of the instrument that measured the data. The CITIfile header shown in Example 1 has just the bare minimum of information necessary; no instrument setup information was included.

An Array of Data

An array is numeric data that is arranged with one data element per line. A CITIfile package may contain more than one array of data. Arrays of data start after the BEGIN keyword, and the END keyword will follow the last data element in an array.

A CITIfile package does not necessarily need to include data arrays; for instance, CITIfile could be used to store the current state of an instrument. In that case the keywords VAR, DATA, BEGIN, and END would not be required.

CITIfile Keyword

Keywords are always the first word on a new line. They are always one continuous word without embedded spaces.

A listing of all the keywords used in the latest A.01.01 version of CITIfile is shown in “The CITIFile Keyword Reference.”

When reading a CITIfile, unrecognized keywords should be ignored. This allows new keywords to be added, without affecting an older program or instrument that might not use the new keywords. The older instrument or program can still use the rest of the data in the CITIfile as it did before. Ignoring unknown keywords allows backwards compatibility to be maintained.

CITIfile Examples

Example 2, An 8510 Display Memory File

Example 2 shows a simple file that contains no frequency information. Some instruments do not keep frequency information for display memory data, so this information is not included in the CITIfile package.

Note that instrument-specific information (#NA = Network Analyzer information) is also stored in this file. This convention allows the designer to define keywords that are particular to his or her particular implementation.

Example

```
CITIFILE A.01.00
#NA VERSION HP8510B.05.00
NAME MEMORY
#NA REGISTER 1
VAR FREQ MAG 5
DATA S RI
BEGIN
-1.31189E-3,-1.47980E-3
-3.67867E-3,-0.67782E-3
-3.43990E-3,0.58746E-3
-2.70664E-4,-9.76175E-4
0.65892E-4,-9.61571E-4
END
```

Example 3, 8510 Data file

Example 3 shows a CITIfile package created from the data register of an 8510 Network Analyzer. In this case 10 points of real and imaginary data was stored, and frequency information was recorded in a segment list table.

Example

```
CITIFILE A.01.00
#NA VERSION HP8510B.05.00
NAME DATA
#NA REGISTER 1
VAR FREQ MAG 10
DATA S[1,1] RI
SEG_LIST_BEGIN
SEG 1000000000 4000000000 10
SEG_LIST_END
BEGIN
0.86303E-1,-8.98651E-1
8.97491E-1,3.06915E-1
-4.96887E-1,7.87323E-1
-5.65338E-1,-7.05291E-1
8.94287E-1,-4.25537E-1
1.77551E-1,8.96606E-1
-9.35028E-1,-1.10504E-1
3.69079E-1,-9.13787E-1
7.80120E-1,5.37841E-1
-7.78350E-1,5.72082E-1
END
```

Example 4, 8510 3-Term Frequency List Cal Set File

Example 4 shows how CITIfile may be used to store instrument setup information. In the case of an 8510 Cal Set, a limited instrument state is needed in order to return the instrument to the same state that it was in when the calibration was done.

Three arrays of error correction data are defined by using three DATA statements. Some instruments require these arrays to be in the proper order, from E1 to E3. In general, CITIfile implementations should strive to handle data arrays that are arranged in any order.

Example

```
CITIFILE A.01.00
#NA VERSION HP8510B.05.00
NAME CAL_SET
#NA REGISTER 1
VAR FREQ MAG 4
DATA E[1] RI
DATA E[2] RI
DATA E[3] RI
#NA SWEEP_TIME 9.999987E-2
#NA POWER1 1.0E1
#NA POWER2 1.0E1
#NA PARAMS 2
#NA CAL_TYPE 3
#NA POWER_SLOPE 0.0E0
#NA SLOPE_MODE 0
#NA TRIM_SWEEP 0
#NA SWEEP_MODE 4
#NA LOWPASS_FLAG -1
#NA FREQ_INFO 1
#NA SPAN 1000000000 3000000000 4
#NA DUPLICATES 0
#NA ARB_SEG 1000000000 1000000000 1
#NA ARB_SEG 2000000000 3000000000 3
VAR_LIST_BEGIN
1000000000
2000000000
2500000000
3000000000
VAR_LIST_END
```

Continued next page

Example (continued)

```
BEGIN
1.12134E-3,1.73103E-3
4.23145E-3,-5.36775E-3
-0.56815E-3,5.32650E-3
-1.85942E-3,-4.07981E-3
END
BEGIN
2.03895E-2,-0.82674E-2
-4.21371E-2,-0.24871E-2
0.21038E-2,-3.06778E-2
1.20315E-2,5.99861E-2
END
BEGIN
4.45404E-1,4.31518E-1
8.34777E-1,-1.33056E-1
-7.09137E-1,5.58410E-1
4.84252E-1,-8.07098E-1
END
```

When an instrument's frequency list mode is used, as it was in Example 4, a list of frequencies is stored in the file after the VAR_LIST_BEGIN statement. The unsorted frequency list segments used by this instrument to create the VAR_LIST_BEGIN data are defined in the #NARB_SEG statements.

Conclusion

The descriptions and examples shown here demonstrate how CITIfile may be used to store and transfer both measurement information and data. The use of a single, common format will allow data to be more easily moved between instruments and computers.

The CITIfile Keyword Reference

Keyword	Explanation and Examples																
CITIFILE	CITIFILE A.01.01 identifies the file as a CITIfile, and indicates the revision level of the file. The CITIFILE keyword and revision code must precede any other keywords. The CITIFILE keyword at the beginning of the package assures the device reading the file that the data that follows is in the CITIfile format. The revision number allows for future extensions of the CITIfile standard. The revision code shown here following the CITIFILE keyword indicates that the machine writing this file is using the A.01.01 version of CITIfile as defined here. Any future extensions of CITIfile will increment the revision code.																
NAME	NAME CAL_SET allows the current CITIfile “package” to be named. The name of the package should be a single word with no embedded spaces. A list of standard package names follows: <table border="0" style="margin-left: 2em;"> <thead> <tr> <th style="text-align: left;">Label</th> <th style="text-align: left;">Definition</th> </tr> </thead> <tbody> <tr> <td>RAW_DATA</td> <td>Uncorrected data.</td> </tr> <tr> <td>DATA</td> <td>Data that has been error corrected. When only a single data array exists, it should be named DATA.</td> </tr> <tr> <td>FORMATTED</td> <td>Corrected and formatted data.</td> </tr> <tr> <td>MEMORY</td> <td>Data trace stored for comparison purposes.</td> </tr> <tr> <td>CAL_SET</td> <td>Coefficients used for error correction.</td> </tr> <tr> <td>CAL_KIT</td> <td>Description of the standards used</td> </tr> <tr> <td>DELAY_TABLE</td> <td>Delay coefficients for calibration.</td> </tr> </tbody> </table>	Label	Definition	RAW_DATA	Uncorrected data.	DATA	Data that has been error corrected. When only a single data array exists, it should be named DATA.	FORMATTED	Corrected and formatted data.	MEMORY	Data trace stored for comparison purposes.	CAL_SET	Coefficients used for error correction.	CAL_KIT	Description of the standards used	DELAY_TABLE	Delay coefficients for calibration.
Label	Definition																
RAW_DATA	Uncorrected data.																
DATA	Data that has been error corrected. When only a single data array exists, it should be named DATA.																
FORMATTED	Corrected and formatted data.																
MEMORY	Data trace stored for comparison purposes.																
CAL_SET	Coefficients used for error correction.																
CAL_KIT	Description of the standards used																
DELAY_TABLE	Delay coefficients for calibration.																
VAR	VAR FREQ MAG 201 defines the name of the independent variable (FREQ), the format of values in a VAR_LIST_BEGIN table (MAG, if used), and the number of data points (201). Typical names for the independent variable are FREQ (in Hz), TIME (in seconds), and POWER (in dBm). For the VAR_LIST_BEGIN table, only the “MAG” format is supported at this point.																
#	#NA POWER1 1.OE1 allows variables specific to a particular type of device to be defined. The pound sign (#) tells the device reading the file that the following variable is for a particular device. The “NA” shown here indicates that the information is for a Network Analyzer. This convention allows new devices to be defined without fear of conflict with keywords for previously defined devices. The device identifier (i.e. NA) may be any number of characters.																
SEG_LIST_BEGIN	SEG_LIST_BEGIN indicates that a list of segments for the independent variable follow. Format for the segments is: [segment type] [start] [stop] [number of points]. The current implementation only supports a single segment. If there is more than one segment, the VAR_LIST_BEGIN construct is used. CITIfile revision A.01.00 supports only the SEG (linear segment) segment type.																
SEG_LIST_END	SEG_LIST_END defines the end of a list of independent variable segments.																

VAR_LIST_BEGIN VAR_LIST_BEGIN indicates that a list of the values for the independent variable (declared in the VAR statement) follow. Only the MAG format is supported in revision A.01.00.

VAR_LIST_END VAR_LIST_END defines the end of a list of values for the independent variable.

DATA DATA S[1,1] RI defines the name of an array of data that will be read later in the current CITIfile package, and the format that the data will be in. Multiple arrays of data are supported by using standard array indexing. Versions A.01.00 and A.01.01 of CITIfile only support the RI (real and imaginary) format, and a maximum of two array indexes. Commonly used array names include the following:

- “S” for “S parameter” Example: S[2,1]
- “E” for “Error term” Example: E[1]
- “USER” for “User parameter” Example: USER[1]
- “VOLTAGE” Example: VOLTAGE[1]
- “VOLTAGE_RATIO” for a ratio of two voltages (A/R) Example: VOLTAGE_RATIO[1,0]

CONSTANT CONSTANT [name] [value] allows for the recording of values which don’t change when the independent variable changes.

CONSTANTS are part of the main CITIfile definition. Users must not define their own CONSTANTS. Use the #KEYWORD device specification to create your own KEYWORD instead. The #NA device specification is an example of this.

No constants were defined for revision A.01.00 of CITIfile. CITIfile revision A.01.01 defined the following constant:

CONSTANT TIME [year] [month] [day] [hour] [min] [secs]

Example:

COMMENT	YEAR	MONTH	DAY	HOUR	MINUTE	SECONDS
CONSTANT TIME	1991	02	26	17	33	53.25

- The COMMENT statement is not absolutely required, but is highly recommended to aid readability.
- The year should always be the full four digits (“1991” is correct, but “91” is not). This is to avoid problems with the year 2000, when the shortened version of the year will be “00.”
- The hour value should be in 24-hour “military” time.
- When writing a CITIfile and the fractional seconds value is zero, then the “seconds” value may be printed either with or without a decimal point: either “47.0” or “47” would be acceptable. When reading a CITIfile, the seconds value should always be read as if it were a floating point number.

Index

1

- 10 MHz precision reference output, 1-11
- 10 MHz reference adjust, 1-11

3

- 3.5 mm test ports
 - measurement uncertainties, 7-8
 - specifications, 7-8

5

- 50 Ω type-N test ports
 - specifications, 7-5

6

- 6 GHz operation option, 1-12

7

- 75 Ω type-F test ports
 - measurement uncertainties, 7-14, 7-17, 7-20, 7-23
 - specifications, 7-14
- 75 Ω type-N test ports
 - measurement uncertainties, 7-11
 - specifications, 7-11
- 75 Ω Impedance option, 1-12
- 7 mm test ports
 - measurement uncertainties, 7-2
- 7 mm test port specifications, 7-2

A

- aborting
 - a print or plot, 4-30
 - a sequence, 2-55
- absolute power calibration, 5-38
- accessories
 - measurement, 11-1
- accuracy
 - frequency drift, 5-3
 - interconnecting cables, 5-2
 - measurement, 5-2
 - temperature drift, 5-2
- accuracy enhancement, 5-7
 - concepts, 6-50–101
 - effectiveness of, 6-69
 - what is, 6-50
- ac line power, 7-36

- activate averaging, 5-57
- activating
 - a fixed marker, 2-11
 - a limit test, 2-43
 - display markers, 2-10
- active
 - channel of display, 1-8
 - entry area of display, 1-8
 - marker control, 2-10
- active and inactive markers, 2-10
- active channel keys, 1-4, 6-8
 - uncoupling stimulus, 6-8
- ac voltage selector switch, 1-10
- adapter kits, 11-2
- adapter removal, 5-42, 6-101
- ADC, 6-5
- additional features, 1-2
- address capability, 11-17
- addresses
 - HP-IB, 6-104, 11-20
- adjust 10 MHz, 1-11
- adjusting the colors of the display, 6-41
- AH1 (full-acceptor handshake), 11-18
- all pages of values printed or plotted, 4-31
- alternate sweep mode, 6-23, 6-100
- altitude conditions, 7-36
- amplifier testing, 6-145–148
 - parameters, 6-145
 - power level metering, 6-148
- amplitude
 - search using markers, 2-22
 - tracking, 2-25
- amplitude and phase tracking, 3-27
- analog in menu, 6-27
- analog-to-digital converter, 6-5
- analyzer
 - capabilities and features, 1-2
 - command syntax, 11-21
 - control of peripherals, 11-20
 - display, 1-6
 - display markers, 2-9
 - electrical delay block, 6-6
 - front panel features, 1-4
 - options available, 1-12
 - register contents, 4-33
 - single bus concept, 11-19

- analyzer description, 1-2
- analyzer display
 - measurement setup diagram, 3-31
- annotations of display, 1-7
- anti-static mat, 7-36
- application and operation concepts, 6-1
- applications
 - amplifier testing, 6-145-148
 - mixer testing, 6-149-160
 - on-wafer measurements, 2-76
- arrays
 - flexibility, 4-36
 - format, 6-7
 - format , 4-36
 - raw data , 4-36
- assign classes, 5-29, 5-31
- atmospheric conditions, 7-36
- ATN (attention) control line, 11-17
- attention (ATN) control line, 11-17
- attenuation at mixer ports, 3-2
- attenuator, 6-2
 - allowing repetitive switching, 6-19
 - switch protection, 6-19
- AUTO-FEED , 4-12
- AUTO-FEED use, 4-5
- automated measurements, 6-138-144
- automatic file naming convention for LIF
 - format, 4-19
- auto sweep time mode
 - how to set, 5-51
- auxiliary input connector location, 1-11
- available options, 1-12
- averaging, 6-44
 - changes, 5-56
 - sweep-to-sweep, 6-5
- averaging factor
 - how to widen, 5-52
- AVG** key, 6-44
- AVG** menu map, 8-2
- Avg status notation, 1-7

B

- ←** key, 6-10
- bandpass mode
 - fault location measurements, 6-123
 - reflection measurements, 6-119
 - transmission measurements, 6-121
- bandwidth
 - system:how to widen, 5-52
- basic measurement sequence and example, 2-3
- basic system maintenance service option, 1-13
- basic talker (T6), 11-18

- battery backup for memory, 12-2
- battery life, 4-33
- bias inputs and fuses locations, 1-11
- bi-directional lines, 11-16
- blanking the display, 6-42
- broad band power meter calibration
 - connections, 3-13
- bus
 - device modes, 11-19
 - structure, 11-15, 11-16

C

- C10 (pass control capabilities), 11-18
- C1,C2,C3 (system controller capabilities), 11-18
- C2 status notation, 1-7
- cabinet, 11-4
- cabinet dimensions, 7-37
- cables
 - HP-IB, 11-5
 - interconnecting, 5-2
 - interface, 11-5
 - test port return, 11-2
- calculate statistics of the measurement data, 2-26
- calibrate menu, 6-73
- calibrating
 - noninsertable devices, 5-39
- calibration
 - concepts, 6-50-101
 - considerations, 6-65
 - data lost, 12-2
 - device measurements, 6-65
 - fast 2-port, 5-54
 - for mixer measurements, 3-6
 - for non-insertable devices, 6-101
 - for noninsertable devices, 5-41
 - full two-port, 6-73
 - in memory, 12-2
 - interpolated error-correction, 6-72
 - measurement parameters, 6-65
 - modifying kits, 6-76
 - omitting isolation, 6-65
 - one-port, 6-73
 - power meter, 5-33, 6-95
 - procedure to modify a user kit, 6-76
 - receiver, 5-11
 - response, 6-73
 - response and isolation, 6-73
 - restarting, 6-75
 - saving data, 6-65
 - specifying kits, 6-75
 - standard devices, 6-66
 - standards, 5-6
 - temperature, 12-5

- TRL*/LRM*, 6-85
- TRL*/LRM* two-port, 6-74
- using on multiple analyzers, 12-5
- validity of, 6-71
- verify performance of, 6-84
- calibration arrays
 - memory requirements, 12-3
 - saving, 4-37
- calibration constants
 - entering, 5-26
 - examining, 5-26
 - modifying, 5-26
 - saving modified kit, 5-28
- calibration factors entry, 5-34
- calibration kit
 - class assignments, 6-81
 - definitions, 6-76
 - label standard menu, 6-81
 - modify menu, 6-77
 - saving modified or user kit, 5-28
 - specify offset, 6-80
 - standard definitions, 6-78
 - terminology, 6-76
- calibration kits, 11-1
- calibration sets
 - using, 12-5
- calibration standards
 - defining, 6-91
 - definitions, 5-26
 - electrical delay of, 5-6
 - electrical offset, 6-67
 - fabricating, 6-91
 - frequency response of, 6-66
 - fringe capacitance, 6-67
 - modifying, 5-26
 - optimizing, 5-6
 - outline of modification, 5-26
- CAL** key, 6-71
- cal kit menu, 6-75
- CAL** menu map, 8-3
- capabilities of the analyzer, 1-2
- care of connectors, 2-2
- cascading multiple sequences, 2-61
- caution messages
 - on LCD, 10-1
- ⏏** key, 6-10
- center frequency set with markers, 2-18
- centronics interface, 7-35
- centronics (parallel) interface, 1-10
- changes between the HP 8753A/B/C/D, 1-13
- change system bandwidth, 5-57
- changing
 - parameters, 5-5
- changing the sequence title, 2-58
- channel 1 and 2 ratio measurement, 2-7
- channel display titling, 2-8
- channel keys, 6-8
 - uncoupling stimulus, 6-8
- channel power
 - coupling, 6-15
- channel power coupling
 - harmonic operation, 6-115
- channel stimulus coupling, 6-20
- channel viewing, 2-5
- characteristic power meter calibration speed
 - and accuracy, 5-33
- characteristics, 7-1
- characterizing microwave systematic errors, 6-53
- characters that are valid, 11-22
- choosing
 - display elements, 4-12
 - scale, 4-15
- chop sweep mode, 6-23, 6-100
 - how to activate, 5-54
- class label, 5-30, 5-32
- cleaning of connectors, 2-2
- clearing a sequence from memory, 2-57
- clock setting, 4-30, 11-13
- CMOS memory, 12-2
- code naming conventions, 11-21
- color printer use, 4-6
- colors
 - modify menu, 6-42
 - recalling, 6-42
 - saving, 6-42
 - setting default, 6-42
- command
 - syntax, 11-21
 - to key cross reference, 9-48
- compatible
 - plotters, 11-4
 - printers, 11-4
- compensating for
 - directional coupler response, 5-35
 - electrical delay of calibration standards, 5-6
- complete service request capabilities (SR1), 11-18
- completion time for measurements, 7-33
- compression measurement, 2-45
- computer, 11-6
 - controllers, 11-15
 - what you can save to , 4-34
- concepts
 - accuracy enhancement, 6-50-101
 - active channel, 6-8
 - application and operation, 6-1
 - calibration, 6-50-101
 - connections, 6-161

- data processing, 6-4-7
- entry keys, 6-9-10
- error-correction, 6-50-101
- frequency domain, 6-117-137
- instrument state, 6-102-108
- markers, 6-47-49
- measurement calibration, 6-50-101
- response function, 6-25-46
- sequencing, 6-138-144
- stimulus function, 6-11-24
- system overview, 6-2-3
- time domain, 6-117-137
- conditions for environment, 7-36
- conditions for error-correction, 5-4
- configuration
 - external disk drive, 11-12
 - plotter, 4-8, 11-9
 - power meter, 11-12
- configuring
 - a plot function, 4-8
 - a print function, 4-3
 - interface port, 11-12
 - printer, 4-4, 4-9, 11-8
 - the analyzer for the printer, 4-4
- configuring the analyzer for the peripheral, 4-8, 11-8
- connecting peripherals, 11-7
- connections, 6-161
 - adapters, 6-161
 - broad band power meter calibration, 3-13
 - conversion loss using the tuned receiver mode, 3-22
 - down converter port, 3-3
 - first portion of conversion compression measurement, 3-29
 - fixture design, 6-162
 - fixtures, 6-162
 - group delay measurement, 3-25
 - high dynamic range swept IF conversion loss measurement, 3-15
 - mixer isolation measurement, 3-34
 - mixer RF feedthrough measurement, 3-36
 - one-sweep power meter calibration for mixer measurements, 3-9
 - peripheral to analyzer, 4-8
 - printer to analyzer, 4-3
 - Rchannel and source calibration, 3-8
 - receiver calibration, 3-14
 - response calibration, 3-18, 3-34, 3-36
 - second portion of conversion compression measurement, 3-30
 - up converter port, 3-3
- connection techniques, 2-2
- connector
 - auxiliary input, 1-11
 - care of, 2-2
 - care quick reference, 2-2
 - external am, 1-11
 - external trigger, 1-11
 - for external monitor, 1-10, 1-11
 - for HP-IB, 1-10
 - for keyboard, 1-10
 - limit test, 1-11
 - parallel (centronics) interface, 1-10
 - probe power source, 1-5
 - R channel, 1-5
 - serial (RS-232) interface, 1-10
 - test sequence, 1-11
 - test set interconnect, 1-11
- connector repeatability, 5-2
- connectors
 - rear panel, 1-10
- connectors on front panel, 7-33
- connectors on rear panel, 7-34
- considerations for mixer measurements, 3-2
- contents
 - of disk file, 4-33
 - of internal memory registers, 4-33
- continuous and discrete markers, 2-9
- continuous correction mode for power meter calibration, 5-37
- continuous mode, test set switch, 5-54
- controller
 - external, 11-6
 - interface function, 11-15
- control lines, 11-16
- controlling the test set switch, 5-54
- conventions for code naming, 11-21
- conversion, 6-6
- conversion compression mixer measurement, 3-28
- conversion loss
 - and output power as a function of input power level example, 3-28
 - equation, 3-11
 - example measurement, 3-11
 - procedure, 3-12
 - using the frequency offset mode, 3-7
 - using the tuned receiver mode connections, 3-22
 - using tuned receiver mode, 3-17
- conversion menu, 6-27
- (COPY) menu map, 8-5
- correcting for measurement errors, 6-71
- correction, 5-7
 - changing parameters, 5-5
 - stimulus state, 5-5
 - types, 5-4
- correction procedures
 - use of, 5-5

- Cor status notation, 1-7
- couple and uncouple display markers, 2-14
- coupled
 - channels, 2-6, 2-7
 - markers, 6-8
- coupling
 - channel power, 6-15
 - channel stimulus, 6-20
 - port power, 6-15
 - power, 6-15
- creating a sequence, 2-54
- cross reference of key function to HP-IB
 - command, 9-48
- crosstalk, 6-53
 - reducing, 5-57
 - uncorrected specifications, 7-2
- C? status notation, 1-7
- CW time sweep, 6-23
- CW time-to-frequency domain, 6-134

D

- damage level, 7-28
- data
 - bus, 11-16
 - divided by memory, 2-7
 - loss of power calibration, 5-33
 - processing, 6-4-7
 - rate, 11-17
 - statistics, 2-26
 - trace saved to the display memory, 2-6
 - transfer, 11-16
 - units, 11-23
- data and memory viewing, 2-6
- data arrays
 - flexibility, 4-36
- data point
 - definition of, 6-5
- data processing flow diagram, 4-37
- data retention
 - for internal memory, 4-33
- data storage
 - types of, 12-1
- DC1 (complete device clear), 11-18
- debug mode, 11-23
- decrease
 - frequency span, 5-50
 - the sweep rate, 5-48
 - the time delay, 5-49
- default
 - file names, 4-33
 - line types for plotter, 4-14
 - pen numbers for plot elements, 4-13
 - plotting parameters, 4-16
 - printing parameters, 4-6
- default settings, 12-6

- plotter pen numbers, 4-13
- defined plotting components, 4-12
- define standard menus, 6-78
- defining
 - a plot, 4-12
 - the print, 4-5
- definition of
 - calibration standards, 5-26
- definition of front panel keys, 9-2
- delay
 - electrical, 6-38
- delay block
 - electrical, 6-6
- deleting
 - all instrument state files, 4-41
 - an instrument state, 4-41
 - a single instrument state file, 4-41
 - frequency segments, 5-35
 - limit segments, 2-42
 - sequence commands, 2-56
- Del status notation, 1-7
- delta (Δ) markers, 2-11
- description and options, 1-1
- description of hardkeys and softkeys, 9-2
- designing fixtures, 6-162
- deviation from linear phase measurement, 2-32
- device clear (DC1), 11-18
- device types for HP-IB, 11-15
- diagram of measurement frequencies, 3-10
- differences between
 - port extensions and electrical delay, 5-3
 - the HP 8753A/B/C/D, 1-13
- dimensions of 7 mm test port, 7-33
- dimensions of analyzer, 7-37
- DIN keyboard, 7-36
- directional coupler compensation, 5-35
- directivity, 6-51
 - uncorrected specifications, 7-2
- directory size, 12-4
- discrete and continuous markers, 2-9
- disk
 - external, 12-4
 - file contents, 4-33
 - formatting, 4-43
 - internal, 12-4
 - storage of a sequence, 2-59
 - storage problems, 4-43
 - storing data, 12-4
- disk drive
 - configuring to plot, 4-11
 - location, 1-4
- disk files
 - using with other models, 12-5
- dispersion effects, 6-94

- display
 - blanking, 6-42
 - format, 6-29
 - information, 1-6
 - location, 1-4
 - markers, 2-9
 - markers activation, 2-10
 - memory, 6-7
 - memory trace, 2-6
 - of analyzer, 1-6
 - setting intensity, 6-41
 - status notations, 1-7
 - titling, 2-8
 - trace math, 2-7
- displayed measurement title, 4-29
- display format
 - group delay, 6-30
 - imaginary, 6-34
 - linear magnitude, 6-33
 - log magnitude, 6-29
 - phase, 6-30
 - polar, 6-32
 - real, 6-34
 - smith chart, 6-31
 - SWR, 6-33
- display functions, 2-5, 6-39
 - color, 6-41
 - dual channel, 6-40
 - DISPLAY** key, 6-39
 - DISPLAY** menu map, 8-6
- divide measurement data by the memory
 - trace, 2-7
- documents
 - reference, 6-163
- does not respond to parallel poll (PPO), 11-18
- DOS format, 11-5
- down converter port connections, 3-3
- drift
 - frequency, 5-3
 - temperature, 5-2
- DT1 (responds to a group execute trigger), 11-18
- dual channel, 6-8
- dual channel mode, 2-5, 6-40
 - problems with, 6-40
- dual trace, 6-8
- duration of measurements, 7-33
- dynamic accuracy, 7-31
 - specifications, 7-29
- dynamic range, 7-1
 - increasing, 5-56
 - limitations, 7-1

E

- E2 (tri-state drivers), 11-18
- edit
 - list menu, 6-23
 - subsweep menu, 6-24
- editing
 - a sequence, 2-56
 - frequency segments, 5-34
 - limits, 6-107
 - limit segments, 2-42
 - segments, 6-107
 - test sequences, 6-139
- electrical
 - delay block, 6-6
- electrical delay, 6-38
 - of calibration standards, 5-6
- electrical length and phase distortion
 - measurement, 2-30
- electrically long devices
 - causes of measurement problems, 5-48
 - how to improve measurement results, 5-48
 - making accurate measurements of, 5-48
- electrical offset, 6-67
- electrostatic precautions, 7-36
- end or identify (EOI) control line, 11-17
- ensuring valid calibration, 6-71
- entering calibration constants, 5-26
- entry block location, 1-5
- entry keys, 6-9-10
- ENTRY OFF** key, 6-10
- environmental characteristics, 7-36
- EOI (end or identify) control line, 11-17
- error-correction, 2-4, 5-2, 5-7
 - calibration standards, 5-6
 - changing parameters, 5-5
 - characteristics affected, 5-4
 - concepts, 6-50-101
 - conditions, 5-4
 - full two-port calibration, 6-73
 - full two-port measurements, 5-20
 - interpolated, 5-6
 - invalidating, 5-5
 - one-port calibration, 6-73
 - one-port reflection measurements, 5-17
 - response and isolation, 6-73
 - response and isolation for reflection
 - measurements, 5-13
 - response and isolation for transmission
 - measurements, 5-15
 - response calibration, 6-73
 - response for reflection measurements, 5-8
 - response for transmission measurements,
 - 5-10
 - TRL*, 5-23
 - TRL*/LRM* two-port calibration, 6-74

- TRM*, 5-23
- types, 5-4
- error messages, 10-2
 - alphabetically listed, 10-2-25
 - numerically listed, 10-26-31
- error model
 - device measurement, 6-59
 - one-port, 6-53
 - two-port, 6-59
- errors
 - removing, 5-4
- ESD precautions, 7-36
- examining calibration constants, 5-26
- example
 - conversion loss and output power as a
 - function of input power level, 3-28
 - conversion loss measurement, 3-11
 - fixed IF mixer measurement, 3-23
 - group delay measurement, 3-26
 - mixer LO to RF isolation measurement, 3-35
 - mixer RF feedthrough measurement, 3-37
 - plot quadrants, 4-17, 4-28
 - plotting two files on the same page, 4-27
 - printing two measurements, 4-7
 - signal flow in a mixer, 3-33
 - spectrum of RF, LO, and IF signals present
 - in a conversion loss measurement, 3-7
 - swept IF conversion loss measurement, 3-16
 - swept power conversion compression
 - measurement, 3-32
 - viewing both channels with a split display, 2-5
- example procedures, 2-1
- extended listener capabilities (LEO), 11-18
- external
 - am connector location, 1-11
 - monitor connector, 1-11
 - trigger connector location, 1-11
- external AM input (EXT AM), 7-34
- external auxiliary input (AUX INPUT), 7-34
- external controller, 11-6
- external disk, 12-4
- external disk drive
 - configuration, 11-12
 - how to solve problems with, 4-43
- external keyboard, 7-36
- external monitor connector, 1-10
- external reference frequency input (EXT REF INPUT), 7-34
- external source mode, 6-109
 - applications, 6-109
 - auto, 6-110
 - capture range, 6-111

- CW frequency range, 6-111
- description, 6-110
- frequency modulation, 6-111
- manual, 6-110
- requirements, 6-111
- specifications, 7-29
- sweep types, 6-111
- test setup, 6-110
- external trigger circuit, 7-35
- external trigger (EXT TRIGGER), 7-34
- external video monitor, 7-35
- ext mon. connector, 1-10, 1-11
- ext status notation, 1-7

F

- fan location, 1-11
- fast 2-port calibration, 5-54
- faster sweep speed, 5-50
- fault location measurements
 - using low pass mode, 6-123
- feature differences between
 - HP 8753A/B/C/D, 1-13
- features
 - rear panel, 1-10
- features added to the analyzer, 1-2
- features of front panel, 1-4
- feedthrough
 - RF, 3-35
- file
 - deleting, 4-41
 - how to re-save, 4-41
 - recalling, 4-42
 - renaming, 4-42
 - saving, 4-33
- file contents
 - floppy disk, 4-33
 - internal memory registers, 4-33
- file names, 12-4
 - default, 4-33
- filtering for mixers, 3-2
- first portion of conversion compression
 - measurement connections, 3-29
- fixed IF mixer measurement
 - example, 3-23
- fixed IF mixer measurements, 3-17
- fixed markers, 2-11
- fixture design, 6-162
- flag markers for gating, 2-70
- flat limit lines, 2-37
- floppy disk file contents, 4-33
- format, 6-7
 - area of display, 1-8
 - arrays, 6-7
 - menu, 6-29
- FORMAT** key, 6-29

- format markers
 - polar, 2-14
 - Smith, 2-15
- FORMAT** menu map, 8-6
- formatting
 - a disk, 4-43
- FORMFEED**, 4-29
- forward transform, 6-135
 - demodulating the results, 6-135
 - range, 6-136
- frequency
 - drift, 5-3
 - response and isolation error-corrections, 5-13
 - selection for mixers, 3-2
 - specifications, 7-27
- frequency domain
 - concepts, 6-117-137
 - transform from CW time, 6-134
- frequency offset
 - specifications, 7-29
- frequency offset mode, 3-7
 - mixer testing, 6-149
 - operation, 3-4
- frequency offset operation, 6-112
 - applications, 6-112
 - compatible instrument modes, 6-113
 - description, 6-113
 - display annotations, 6-114
 - error message, 6-114
 - frequency hierarchy, 6-113
 - frequency ranges, 6-113
 - LO frequency, 6-113
 - offset frequency, 6-113
 - receiver and source requirements, 6-114
 - receiver frequency, 6-113
 - spurious signals, 6-114
 - test setup, 6-112
- frequency range
 - defining, 6-11
- frequency response, 6-53
 - error-corrections, 5-8
- frequency response of calibration standards, 6-66
- frequency span
 - decrease, 5-50
- frequency-to-time domain, 6-117
- fringe capacitance, 6-67
- front panel access key for softkeys, 9-69
- front panel connectors, 7-33
- front panel features, 1-4
- front-panel key definitions, 9-2
- full-acceptor handshake (AH1), 11-18
- full-source handshake (SH1), 11-18
- full two-port

- calibration, 6-73
- error-correction, 5-20

G

- gain and reverse isolation measurement, 2-49
- gain compression measurement, 2-45
- gate
 - flags, 2-70
 - parameter setting, 2-70
 - shaping, 2-70
- gate span setting, 2-70
- gating, 6-6
 - procedure, 2-70
 - time domain, 6-133
- gating effects in frequency domain, 2-72
- Gat status notation, 1-7
- G+jB MKR, 2-16
- GPIO interface, 1-10
- GPIO mode, 6-105, 6-139
- group delay, 6-35
 - format, 6-30
 - measurement, 2-33
 - measurement connections, 3-25
 - measurement example, 3-26
 - mixer measurements, 3-24
 - specifications, 7-31
- group delay accuracy vs. aperture, 7-31
- group delay or phase mixer measurements, 3-24
- group execute trigger response (DT1), 11-18
- guidelines for code naming, 11-21

H

- H=2 status notation, 1-8
- H=3 status notation, 1-8
- handshake lines, 11-16
- hardkey definitions, 9-2
- harmonic mode option, 1-12
- harmonic operation, 6-115
 - accuracy, 6-116
 - coupling channel power, 6-115
 - dual-channel, 6-115
 - frequency range, 6-116
 - input power, 6-116
 - single-channel, 6-115
 - test setup, 6-115
- harmonics
 - specifications, 7-27
- harmonics measurement, 2-66
- harmonics (option 002)
 - specifications, 7-28
- high dynamic range swept IF conversion loss
 - measurement connections, 3-15

- high dynamic range swept RF/IF conversion loss, 3-12
- high-stability frequency reference(10 MHz) (option 001), 7-34
- high stability frequency reference option, 1-12
- Hld status notation, 1-8
- hold mode, test set switch, 5-54
- how to
 - abort a print or plot process, 4-30
 - activate a fixed marker, 2-11
 - activate chop sweep mode, 5-54
 - activate display markers, 2-10
 - calculate data statistics, 2-26
 - calibrate the analyzer receiver to measure absolute power, 5-38
 - change measurement averaging, 5-56
 - change system bandwidth, 5-56
 - change the sequence title, 2-58
 - clean connectors, 2-2
 - clear a sequence from memory, 2-57
 - compensate for directional coupler response, 5-35
 - configure a plot function, 4-8
 - configure a plot function to disk drive, 4-11
 - configure a plot function using and HPGL/2 compatible printer, 4-8
 - configure a plot function using a pen plotter, 4-10, 11-11
 - configure a print function, 4-3
 - construct a loop structure in a sequence, 2-62
 - control the test set switch, 5-54
 - couple and uncouple display markers, 2-14
 - create a limit test sequence, 2-64
 - create a test sequence, 2-54
 - create flat limit lines, 2-37
 - create single point limits, 2-41
 - create sloping limit lines, 2-39
 - decrease frequency span, 5-50
 - define line types, 4-14
 - define the plot, 4-12
 - define the print, 4-5
 - delete all instrument state files, 4-41
 - delete an instrument state, 4-41
 - delete a single instrument state file, 4-41
 - delete limit segments, 2-42
 - divide measurement data by the memory trace, 2-7
 - edit a sequence, 2-56
 - edit limit segments, 2-42
 - edit power calibration factors, 5-34
 - enter the power sensor calibration data, 5-34
 - error-correct for frequency response, 5-8
 - error-correct for frequency response and isolation, 5-13
 - error-correct for full two-port measurements, 5-20
 - error-correct for one-port reflection measurements, 5-17
 - error-correct for response and isolation for reflection measurements, 5-13
 - error-correct for response and isolation for transmission measurements, 5-15
 - error-correct for TRL*, 5-23
 - error-correct for TRM*, 5-23
 - error-correct measurements, 5-7
 - error-correct response for reflection measurements, 5-8
 - error-correct response for transmission measurements, 5-10
 - format a disk, 4-43
 - gate out responses, 2-70
 - increase sweep speed, 5-50
 - insert a sequence command, 2-56
 - load a sequence from disk, 2-60
 - make a basic measurement, 2-3
 - make accurate measurements of electrically long devices, 5-48
 - measure conversion loss using tuned receiver mode, 3-17
 - measure deviation from linear phase, 2-32
 - measure devices using the time domain, 2-68
 - measure electrical length and phase distortion, 2-30
 - measure fixed IF mixers, 3-17
 - measure gain compression, 2-45
 - measure group delay, 2-33
 - measure group delay or phase for mixers, 3-24
 - measure high dynamic range conversion loss, 3-12
 - measure magnitude and insertion phase response, 2-27
 - measure mixer isolation, 3-33
 - measure mixer LO to RF isolation, 3-33
 - measure mixers, 3-1
 - measure reflection response in time domain, 2-73
 - measure reverse isolation and gain, 2-49
 - measure swept harmonics, 2-66
 - measure swept RF/IF mixers, 3-7
 - measure transmission response in time domain, 2-68
 - modify a sequence command, 2-57
 - modify calibration standards, 5-26
 - modify TRL calibration standards, 5-28

- modify TRM calibration standards, 5-30
- offset limit lines, 2-44
- output a single page of values, 4-30
- output multiple plots to a single page using a printer, 4-25
- output plot files, 4-20
- output plot files from a PC to a plotter, 4-22
- output plot files from a PC to a printer, 4-23
- output single page plots using a printer, 4-24
- output the entire list of values, 4-31
- plot a measurement to disk, 4-19
- plot measurements in page quadrants, 4-28
- plot multiple measurements on a full page, 4-26
- plot multiple measurements per page, 4-17, 4-26
- plot one measurement per page, 4-16
- plot to an HPGL compatible printer, 4-18
- power meter calibrate, 3-6
- print a sequence, 2-60
- print multiple measurements per page, 4-7
- print one measurement per page, 4-6
- print or plot list values or operating parameters, 4-30
- purge a sequence from disk, 2-60
- ratio measurements in channel 1 and 2, 2-7
- recall a file, 4-42
- reduce receiver crosstalk, 5-57
- reduce receiver noise floor, 5-56
- reduce the averaging factor, 5-52
- reduce the number of points, 5-52
- reduce trace noise, 5-57
- rename a file, 4-42
- re-save a file, 4-41
- reset plotting parameters to default values, 4-16
- reset the printing parameters to default values, 4-6
- review limit line segments, 2-43
- run a limit test, 2-43
- run a test sequence, 2-55
- save a data trace to the display memory, 2-6
- save an instrument state, 4-35
- save measurement results, 4-36
- search for a target amplitude, 2-24
- search for bandwidth, 2-25
- search for maximum amplitude, 2-22
- search for minimum amplitude, 2-23
- sequence tests, 2-53
- set auto sweep time mode, 5-51
- set center frequency with markers, 2-18
- set CW frequency using markers, 2-21
- set display reference using markers, 2-20
- set electrical delay using markers, 2-21
- set frequency range, 2-3
- set frequency span with markers, 2-19
- set source power, 2-4
- set start frequency with markers, 2-17
- set stop frequency with markers, 2-17
- set the measurement parameters, 2-3
- set the measurement type, 2-4
- set the sweep type, 5-53
- solve printing or plotting problems, 4-32
- solve problems with disk storage, 4-43
- stop a sequence, 2-55
- store a sequence on a disk, 2-59
- subtract the memory trace from the measurement data trace, 2-7
- title the active channel display, 2-8
- title the displayed measurement, 4-29
- track amplitude, 2-25
- use analyzer display markers, 2-9
- use continuous and discrete markers, 2-9
- use delta (Δ) markers, 2-11
- use frequency offset mode, 3-7
- use limit lines, 2-36
- use `MKR ZERO` to activate a fixed reference marker, 2-13
- use polar format markers, 2-14
- use receiver calibration, 5-11
- use Smith chart markers, 2-15
- use the tuned receiver mode, 2-51
- use the `Δ REF= Δ FIXED MKR` key to activate a fixed reference marker, 2-12
- view a single measurement channel, 5-53
- view both measurement channels, 2-5
- view plot files on a PC, 4-20
- view the measurement data and memory trace, 2-6
- widen system bandwidth, 5-52

HP 8753A/B/C/D differences, 1-13

HPGL

- initialization commands, 4-23
- outputting plot files to compatible printer, 4-23
- test file commands, 4-24

HPGL/2 compatible printer, configuring to plot, 4-8

HP-IB, 11-14

- address capability, 11-17
- addresses, 6-104, 11-20
- bus structure, 11-15, 11-16

- cables, 11-5
- connector, 1-10
- data rate, 11-17
- debug mode, 11-23
- device types, 11-15
- menu, 6-103
- message transfer scheme, 11-17
- multiple-controller capability, 11-17
- operation, 11-15
- operational capabilities, 11-18
- pass control mode, 6-104
- requirements, 11-17
- status indicators, 6-104, 11-19
- system controller mode, 6-104
- talker/listener mode, 6-104
- HP-IB-command to key-function cross
 - reference, 9-48
- HP-IB connector, 7-35
- humidity conditions, 7-36

I

- IF
 - how defined for mixers, 3-2
- IF bandwidth, 6-45
 - how to widen, 5-52
- IFC (interface clear) control line, 11-16
- IF detection, 6-5
- imaginary format, 6-34
- impedance
 - specifications, 7-28
- impedance conversion, 11-2
- increase
 - test port power, 5-56
- increasing
 - dynamic range, 5-56
 - sweep speed, 5-50
- increasing measurement accuracy, 5-2
- information messages, 10-2
- initializing
 - DOS, 11-5
 - LIF, 11-5
- input ports menu, 6-28
- inserting a sequence command, 2-56
- insertion phase and magnitude response
 - measurement, 2-27
- instrument modes, 6-109–116
 - external source, 6-109
 - frequency offset, 6-112
 - harmonic, 6-115
 - network analyzer, 6-109
 - tuned receiver, 6-111
- instrument state, 6-102–108
 - contents, 4-33
 - deleting all files, 4-41
 - deleting a single file, 4-41

- memory requirements, 12-3
 - saving, 4-33, 4-35
- instrument state function block location, 1-5
- instrument state in memory, 12-1
- instrument states in memory, 12-2
- interconnect devices,max.number, 11-17
- interconnecting cables, 5-2
- interconnection cable,max. length, 11-17
- interface
 - addresses, 11-20
 - cables, 11-5
 - GPIO, 1-10
 - parallel, 1-10, 7-35
 - RS-232, 1-10
- interface clear (IFC) control line, 11-16
- interface function codes, 7-33
- interface functions
 - controller, 11-15
 - listener, 11-15
 - talker, 11-15
- interface port
 - configuration, 11-12
- internal memory
 - data retention, 4-33
 - register contents, 4-33
- interpolated calibration
 - restoring, 12-5
- interpolated error-correction, 5-6, 6-72
- isolation, 6-53
 - calibration, 6-73
 - measurements for mixers, 3-33
 - (reverse) and gain measurement, 2-49

K

- keyboard connector, 1-10
- keyboard (DIN), 7-36
- keyboards, 11-6
- key definitions, 9-1
- key menu maps, 8-1
- keys
 - active channel, 6-8
 - AVG**, 6-44
 - ←**, 6-10
 - CAL**, 6-71
 - , 6-10
 - DISPLAY**, 6-39
 - entry, 6-9–10
 - ENTRY OFF**, 6-10
 - FORMAT**, 6-29
 - instrument state, 6-102–108
 - LOCAL**, 6-103
 - MEAS**, 6-26, 6-27
 - MENU**, 6-12
 - ⊖**, 6-10
 - response function, 6-25–46

- step, 6-10
- stimulus function, 6-11-24
- SYSTEM**, 6-109
- units terminator, 6-9
- ▲ ▼**, 6-10
- keys referenced to front panel access key, 9-69
- key to HP-IB command, 9-48
- kit label, 5-30, 5-32
- knob
 - RPG, 6-10

L

- label class menu, 6-83
- label kit, 5-30, 5-32
 - menu, 6-83
- label the classes, 5-30, 5-32
- LCD, 1-6
- LE0 (no extended listener capabilities), 11-18
- LIF format, 11-5
- limit lines, 6-106
- limits
 - editing, 6-107
 - offset, 6-108
- limit segments
 - editing, 6-107
- limit test
 - connector location, 1-11
 - example sequence, 2-64
- limit testing, 2-36
 - activating, 2-43
 - creating flat limit lines, 2-37
 - creating single point limits, 2-41
 - creating sloping limit lines, 2-39
 - deleting limit segments, 2-42
 - editing limit segments, 2-42
 - offsetting limit lines, 2-44
 - pass/fail indicators, 2-44
 - reviewing limit line segments, 2-43
 - running a limit test, 2-43
 - sequencing, 2-64
- limit test output (LIMIT TEST), 7-35
- linear
 - phase deviation measurement, 2-32
- linear frequency sweep, 6-21
- linear magnitude format, 6-33
- line power, 7-36
- lines for control, 11-16
- lines for handshaking, 11-16
- line switch location, 1-4
- LINE TYPE DATA**, 4-14
- LINE TYPE MEMORY**, 4-14
- line types
 - plotter, 4-14

- line types available, 4-14
- line voltage selector switch, 1-10
- LIN MKR, 2-15, 2-16
- listener interface function, 11-15
- listen mode (L), 11-19
- list frequencies
 - modifying, 6-23
- list frequency sweep, 6-22
- list values
 - printing or plotting, 4-30
- L (listen mode), 11-19
- loading a sequence from disk, 2-60
- load match, 6-52
 - uncorrected specifications, 7-2
- LOCAL** key, 6-103
- LOCAL** menu map, 8-7
- location
 - 10 MHz precision reference output, 1-11
 - 10 MHz reference adjust, 1-11
 - active channel keys, 1-4
 - analyzer display, 1-4
 - auxiliary input connector, 1-11
 - bias inputs and fuses, 1-11
 - centronics (parallel) interface, 1-10
 - disk drive, 1-4
 - entry block, 1-5
 - external trigger connector, 1-11
 - fan, 1-11
 - fuse, 1-10
 - instrument state function block, 1-5
 - limit test connector, 1-11
 - line switch, 1-4
 - line voltage selector switch, 1-10
 - P1 and P2 in **SCALE PLOT [GRAT]** mode, 4-15
 - parallel (centronics) interface, 1-10
 - pass/fail message, 1-9
 - port 1 and port 2, 1-5
 - preset key, 1-5
 - probe power source connector, 1-5
 - R channel connectors, 1-5
 - response function block, 1-4
 - RS-232 (serial) interface, 1-10
 - serial number plate, 1-10
 - serial (RS-232) interface, 1-10
 - softkey labels, 1-9
 - softkeys, 1-4
 - stimulus function block, 1-4
 - test sequence connector, 1-11
 - test set interconnect, 1-11
- locations of softkeys, 9-69
- logarithmic frequency sweep, 6-22
- log magnitude format, 6-29
- LOG MKR, 2-15, 2-16
- loop counter sequence, 2-62

loss of power meter calibration data, 5-33
LO to RF isolation for mixers, 3-33
low pass mode
 reflection measurements, 6-123
 setting frequency range, 6-122
 transmission measurements, 6-125

M

magnitude
 specifications, 7-29
magnitude and insertion phase response
 measurement, 2-27
making accurate measurements
 electrically long devices, 5-48
making measurements, 2-1
man status notation, 1-8
marker
 control, 2-10
 values area on display, 1-8
MARKER FCTN menu map, 8-8
MARKER menu map, 8-8
markers
 activating, 2-10
 active and inactive, 2-10
 calculate data statistics, 2-26
 continuous and discrete, 2-9
 couple and uncouple display markers, 2-14
 coupled, 6-8
 delta mode, 6-48
 delta (Δ), 2-11
 fixed, 2-11
 fixed reference, 6-48
 functions, 6-49
 functions on display, 2-9
 G+jB MKR, 2-16
 LIN MKR, 2-15, 2-16
 LOG MKR, 2-15, 2-16
 menu, 6-48
 modes, 6-49
 polar format, 2-14, 6-49
 reference, 2-11
 Re/Im MKR, 2-15, 2-16
 relative mode, 2-11
 R+jX MKR, 2-16
 search for bandwidth, 2-25
 search for maximum amplitude, 2-22
 search for minimum amplitude, 2-23
 search for target amplitude, 2-24
 searching, 2-22
 search mode, 6-49
 set CW frequency, 2-21
 set display reference, 2-20
 set electrical delay, 2-21
 set frequency span, 2-19
 set measurement parameters, 2-16

 setting center frequency, 2-18
 setting start frequency, 2-17
 setting stop frequency, 2-17
 smith chart, 6-49
 Smith chart markers, 2-15
 Smith or polar format, 2-12
 target mode, 6-49
 tracking amplitude, 2-25
 using, 6-47-49
 zero, 2-13
marker stats
 bandwidth on display, 1-9
masking
 time domain, 6-127
mass storage, 11-5
matched adapters
 using to calibrate non-insertable devices,
 6-101
 using to calibrate noninsertable devices,
 5-40
math with data traces, 2-7
maximum amplitude search, 2-22
MEAS key, 6-26, 6-27
MEAS menu map, 8-9
measure
 deviation from linear phase, 2-32
 device under test, 2-4
 electrical length and phase distortion, 2-30
 gain and reverse isolation, 2-49
 gain compression, 2-45
 group delay, 2-33
 increased accuracy, 5-2
 magnitude and insertion phase response,
 2-27
 swept harmonics, 2-66
 transmission response in time domain,
 2-68
 using limit lines, 2-36
 using the time domain, 2-68
measured inputs of display, 1-8
measurement
 channel viewing, 2-5
 conversion loss example, 3-11
 data points:setting, 2-4
 data statistics, 2-26
 error-correction, 5-4
 example, 2-3
 examples, 2-1
 output results, 2-4
 parameters set with markers, 2-16
 sequence, 2-3
 type:setting, 2-4
measurement accuracy
 calibration standards, 5-6
 changing parameters, 5-5

- compensating for directional coupler response, 5-35
- connector repeatability, 5-2
- error-correction, 5-4
- frequency drift, 5-3
- increasing, 5-2
- interconnecting cables, 5-2
- performance verification, 5-3
- reference plane and port extensions, 5-3
- temperature drift, 5-2
- measurement averaging
 - changing, 5-56
- measurement calibration
 - concepts, 6-50-101
- measurement channel, how to view a single, 5-53
- measurement errors
 - causes of, 6-51
 - correcting for, 6-71
 - crosstalk, 6-53
 - directivity, 6-51
 - frequency response, 6-53
 - isolation, 6-53
 - load match, 6-52
 - source match, 6-52
 - tracking, 6-53
- measurement frequencies, diagram, 3-10
- measurement points
 - how to reduce, 5-52
- measurement port specifications, 7-2
 - uncorrected for errors, 7-2
- measurement problems
 - electrically long devices, 5-48
- measurement programs, 11-6
- measurement results
 - saving, 4-36
- measurements
 - conversion loss for mixers, 3-7
 - conversion loss using tuned receiver mode, 3-17
 - high dynamic range conversion loss for mixers, 3-12
 - LO to RF isolation for mixers, 3-33
 - mixer, 3-1
 - mixer considerations, 3-2
 - mixer conversion compression, 3-28
 - mixer group delay or phase, 3-24
 - mixer isolation, 3-33
 - mixers fixed IF, 3-17
 - non-coaxial, 2-76
 - optimized, 5-1
 - optimizing, 4-43
 - power meter calibration for, 3-6
 - RF feedthrough for mixers, 3-35
 - swept RF/IF mixers, 3-7
 - using the tuned receiver mode, 2-51
- measurement setup diagram shown on analyzer display, 3-31
- measurement setup from display, 3-10
- measurement times, 7-33
- measurement title, 4-29
- measurement uncertainties
 - 3.5 mm test ports, 7-8
 - 50 Ω type-N, 7-5
 - 75 Ω type-F test ports, 7-14, 7-17, 7-20, 7-23
 - 75 Ω type-N test ports, 7-11
 - 7 mm test ports, 7-2
- memory
 - available, 12-2
 - battery backup, 12-2
 - CMOS, 12-2
 - conserving, 12-5
 - display, 6-7
 - external disk, 12-4
 - insufficient, 12-3
 - internal disk, 12-4
 - non-volatile, 12-2
 - requirements, 12-3
 - saving calibration data, 12-2
 - saving current instrument state, 12-1
 - saving instrument states, 12-2
 - types of, 12-1
 - volatile, 12-1
- memory-intensive operations, 12-5
- memory math functions, 6-41
- memory register
 - contents, 4-33
- memory trace, 2-6
- memory trace arrays
 - memory requirements, 12-3
- menu
 - calibrate, 6-73
 - cal kit, 6-75
 - HP-IB, 6-103
 - input ports, 6-28
 - limits, 6-106
 - power, 6-13
 - scale reference, 6-38
 - S-parameter, 6-27
 - sweep types, 6-21
 - system, 6-106
 - trigger, 6-18
 - MENU** key, 6-12
- menu map, 8-1
 - AVG**, 8-2
 - CAL**, 8-3
 - COPY**, 8-5
 - DISPLAY**, 8-6
 - FORMAT**, 8-6

- LOCAL**, 8-7
- MARKER**, 8-8
- MARKER FCTN**, 8-8
- MEAS**, 8-9
- MENU**, 8-10
- PRESET**, 8-12
- SAVE/RECALL**, 8-11
- SCALE REF**, 8-12
- SEQ**, 8-13
- SYSTEM**, 8-15
- message area of display, 1-8
- messages
 - error, 10-1
 - information, 10-2
- message transfer scheme, 11-17
- methods of HP-IB operation, 11-15
- microprocessor, 6-3
- microwave connector care, 2-2
- minimum
 - amplitude search, 2-23
- minimum loss pad, 11-2
- ⊖** key, 6-10
- mixer
 - isolation measurement connections, 3-34
 - LO to RE isolation measurement example, 3-35
 - RF feedthrough measurement connections, 3-36
 - RF feedthrough measurement example, 3-37
- mixer measurements, 3-1
- mixers
 - amplitude and phase tracking, 3-27
 - attenuation at ports, 3-2
 - conversion compression, 3-28
 - conversion loss using frequency offset, 3-7
 - conversion loss using tuned receiver mode, 3-17
 - eliminating unwanted signals, 3-2
 - filtering, 3-2
 - fixed IF, 3-17
 - frequency offset mode operation, 3-4
 - frequency selection, 3-2
 - group delay or phase measurement, 3-24
 - high dynamic range conversion loss, 3-12
 - how RF and IF are defined, 3-2
 - isolation measurements, 3-33
 - LO to RF isolation, 3-33
 - minimizing source and load mismatches, 3-2
 - power meter calibration, 3-6
 - reducing the effect of spurious responses, 3-2
 - RF feedthrough, 3-35
 - swept RF/IF measurement, 3-7
 - mixer testing, 6-149–160
 - accuracy, 6-150
 - amplitude and phase tracking, 6-159
 - attenuation, 6-151
 - conversion compression, 6-158
 - conversion loss, 6-156
 - down conversion, 6-153
 - filtering, 6-152
 - frequency accuracy, 6-153
 - frequency offset mode, 6-149
 - frequency selection, 6-153
 - frequency stability, 6-153
 - group delay, 6-159
 - isolation, 6-156
 - LO feedthru, 6-156
 - parameters, 6-150
 - phase linearity, 6-159
 - phase measurements, 6-158
 - return loss, 6-157
 - RF feedthru, 6-157
 - SWR, 6-157
 - tuned receiver mode, 6-149
 - up conversion, 6-153
- MKR ZERO** example procedure, 2-13
- mode
 - auto sweep time, 5-51, 6-16
 - frequency offset, 3-7
 - manual sweep time, 6-16
 - tuned receiver, 3-17
- modes
 - external source, 6-109
 - forward transform, 6-118
 - frequency offset, 6-112
 - harmonic, 6-115
 - instrument, 6-109–116
 - network analyzer, 6-109
 - pass-control, 11-20
 - system-controller, 11-19
 - talker/listener, 11-20
 - tuned receiver, 6-111
- modes for bus device, 11-19
- modified user kit, 5-28
- modify
 - calibration kit menu, 6-77
 - the cal kit thru definition, 5-40
- modifying
 - a sequence, 2-56
 - a sequence command, 2-57
 - calibration constants, 5-26
 - calibration kits, 6-76
 - calibration standards, 5-26
 - list frequencies, 6-23
 - TRL calibration standards, 5-28
 - TRM calibration standards, 5-30
- monitor, 7-35

- connector, 1-11
- monitor connector, 1-10
- monitors, 11-6
- multiple-controller capability, 11-17
- multiple measurements
 - plotted, 4-26
 - printed, 4-7
- multiple sequence cascading, 2-61

N

- naming conventions, 11-21
- network analyzer mode, 6-109
- new features to the analyzer, 1-2
- NEWLINE**, 4-29
- no extended talker capabilities (TEO), 11-18
- noise floor
 - reducing, 5-56
- noise level specifications, 7-28
- noise reduction, 6-44
 - averaging, 6-44
 - IF bandwidth, 6-45
 - smoothing, 6-45
- non-coaxial measurements, 2-76
- non-insertable devices
 - calibrating for, 6-101
- noninsertable devices
 - calibrating for, 5-41
- non-operating storage conditions, 7-36
- non-volatile memory, 12-2
 - available, 12-2
- notations of display, 1-7
- number of HP-IB devices allowed, 11-15
- number of listeners allowed, 11-15
- number of points
 - how to reduce, 5-52
- number of sweeps, test set switch, 5-54

O

- offset, 6-7
 - limits, 6-108
 - R-Channel, 3-4
 - specify, 6-80
- offsetting limit lines, 2-44
- Ofs status notation, 1-7
- Of? status notation, 1-7
- one-port calibration, 6-73
- one-sweep power meter calibration for mixer
 - measurements connections, 3-9
- on-site system verification option, 1-13
- on-wafer measurements, 2-76
- operating conditions, 7-36
- operating parameters
 - printing or plotting, 4-30
- operation
 - frequency offset, 6-112

- harmonic, 6-115
 - of the network analyzer, 6-2
- operational capabilities for HP-IB, 11-18
- operation concepts, 6-1
- operation of HP-IB, 11-15
- operations
 - instrument, 6-109-116
- optimizing
 - calibration standards, 5-6
 - measurement results, 5-1
 - measurements, 4-43
- option
 - 002, harmonic mode, 1-12
 - 006, 6 GHz operation, 1-12
 - 010, time domain, 1-12
 - 011, receiver configuration, 1-12
 - +02A, standard system maintenance service, 1-13
 - +02B, basic system maintenance service, 1-13
 - 075, 75 Ω impedance, 1-12
 - 1CM, rack mount flange kit without handles, 1-12
 - 1CP, rack mount flange kit with handles, 1-12
 - 1D5, high stability frequency reference, 1-12
 - +22A, return to HP full service agreement, 1-13
 - 22B, return to HP repair agreement, 1-13
 - +22C, return to HP calibration agreement, 1-13
 - +22G, return to HP calibration, 1-13
 - +23G, on-site system verification, 1-13
 - service and support, 1-13
- option 001
 - specifications, 7-34
- option 002, 6-115
- Option 010, 6-117-137
- options and description, 1-1
- options available, 1-12
- output
 - video, 7-35
- output power
 - specifications, 7-27
- outputting
 - measurement results, 4-1
 - multiple plots to a single page using a printer, 4-25
 - plot files, 4-20
 - single page plots using a printer, 4-24
- outputting plot files
 - from a PC to a plotter, 4-22
 - from a PC to a printer, 4-23
- overview

- system, 6-2-3

P

- P1 and P2 on the plotter, 4-15
- page halves, 4-7
- page of values printed or plotted, 4-30
- page quadrants, 4-28
- panel
 - rear, 1-10
- parallel interface, 1-10
- parallel poll non response (PPO), 11-18
- parallel port, 7-35
 - copy mode, 6-105
 - GPIO mode, 6-105, 6-139
 - plotting, 6-105
 - printing, 6-105
 - TTL input, 6-140
 - TTL output, 6-140
 - use of, 6-105
- parameters
 - defaults for plotting, 4-16
 - defaults for printing, 4-6
 - operating:printing or plotting, 4-30
- parameters set with markers, 2-16
 - center frequency, 2-18
 - CW frequency, 2-21
 - display reference, 2-20
 - electrical delay, 2-21
 - frequency span, 2-19
 - start frequency, 2-17
 - stop frequency, 2-17
- pass control
 - mode, 6-104
- pass control capabilities (C10), 11-18
- pass-control mode, 11-20
- pass/fail
 - display location, 1-9
 - indicators in limit testing, 2-44
- pass fail indicators on display, 1-9
- PC? status notation, 1-8
- PC status notation, 1-8
- P↓ status notation, 1-8
- pen number settings, 4-13
- `PEN NUM DATA`, 4-13
- `PEN NUM GRATICULE`, 4-13
- `PEN NUM MARKER`, 4-13
- `PEN NUM MEMORY`, 4-13
- `PEN NUM TEXT`, 4-13
- pen plotter
 - configuring to plot, 4-10, 11-11
 - plotting multiple measurements per page, 4-17
- performance verification

- measurement accuracy, 5-3
- peripheral
 - addresses, 11-20
 - configurations, 4-4, 4-8, 11-8
 - connections to analyzer, 4-8
- peripheral equipment, 6-3
- peripherals, 11-1
 - connecting, 11-7
- phase
 - specifications, 7-29
- phase and magnitude response measurement, 2-27
- phase characteristics, 7-31
- phase distortion and electrical length measurement, 2-30
- phase format, 6-30
- physical dimensions, 7-37
- plot
 - aborting, 4-30
 - defined boundaries, 4-15
 - definition, 4-12
 - filename convention, 4-26
 - multiple measurements per page, 4-26
 - solving problems, 4-32
- `PLOT DATA`, 4-12
- plot files
 - how to view on a PC, 4-20
 - outputting from a PC to a plotter, 4-22
 - outputting from a PC to a printer, 4-23
- `PLOT GRAT`, 4-12
- `PLOT MEM`, 4-12
- `PLOT MKR`, 4-12
- plot speed, 4-15
- plotter
 - configuration, 4-8, 11-9
 - line types, 4-14
 - pen number settings, 4-13
- plotter P1 and P2, 4-15
- plotters, 11-4
- `PLOT TEXT`, 4-12
- plotting
 - a measurement to disk, 4-19
 - arrays, 4-12
 - components defined, 4-12
 - measurement results, 4-3
 - multiple measurements on a full page, 4-26
 - multiple measurements per page, 4-17
 - page quadrants, 4-28
 - start, 4-16
 - to an HPGL compatible printer, 4-18
- plotting, printing, and saving, 4-1
- point limit creation, 2-41

- points
 - data:how to reduce, 5-52
- pola format
 - markers, 2-14
- polar chart markers
 - LIN MKR, 2-15
 - LOG MKR, 2-15
 - Re/Im MKR, 2-15
- polar format, 6-32
- polar or Smith format markers, 2-12
- port 1 and port2, 1-5
- port coupling, 6-15
- port extensions, 5-3
- port power
 - increasing, 5-56
- power
 - coupling, 6-15
 - increasing test port, 5-56
 - line, 7-36
 - menu, 6-13
 - probe, 7-34
- power cord receptacle with fuse, 1-10
- power level, calibrated, 6-95
- power meter
 - calibration, 5-33
 - calibration for mixer measurements, 3-6
 - configuration, 11-12
- power meter calibration, 6-95
 - accuracy, 6-98, 6-99
 - applications, 6-95
 - compatible sweep types, 6-95
 - continuous correction mode, 5-37
 - continuous sample mode, 6-96
 - interpolation, 6-96
 - loss of, 6-96
 - loss of calibration data, 5-33
 - modes of operation, 6-96
 - power level, 6-95
 - power loss correction list, 6-98
 - power sensor calibration data, 6-98
 - receiver to measure absolute power, 5-38
 - sample-and-sweep correction mode, 5-36
 - sample-and-sweep mode, 6-97
 - speed, 6-98
 - stimulus parameters, 6-98
- power (output) characteristics, 7-27
- power ranges, 6-13
 - auto, 6-13
 - manual, 6-13
- power sensor
 - calibration data, 5-34
 - calibration factor list, 6-98
- power sweep, 6-23
- power sweep range
 - defining, 6-11
- PPO (does not respond to parallel poll, 11-18
- precautions
 - electrostatic, 7-36
- pre-raw data arrays, 6-6
- preset
 - key location, 1-5
 - PRESET** menu map, 8-12
- preset state, 12-6
- principles of microwave connector care, 2-2
- print
 - aborting, 4-30
 - definition, 4-5
 - multiple measurements per page, 4-7
 - solving problems, 4-32
- PRINT ALL** use, 4-31
- printer
 - color, 4-6
 - configuration, 4-4, 4-9, 11-8
 - mode, 4-6
 - outputting single page plots to, 4-24
 - using to output multiple plots to a single page, 4-25
- printer connections to analyzer, 4-3
- printers, 11-4
- printing
 - default setting, 4-6
 - measurement results, 4-3
 - start, 4-6
 - two measurements, 4-7
- printing a sequence, 2-60
- printing or plotting list values or operating parameters, 4-30
- printing, plotting, and saving, 4-1
- print/plot time stamp, 4-30, 11-13
- PRm status notation, 1-8
- probe power, 7-34
- probe power source connector location, 1-5
- problems
 - with disk storage, 4-43
 - with printing or plotting, 4-32
- procedure
 - aborting a print or plot process, 4-30
 - activating a fixed marker, 2-11
 - activating display markers, 2-10
 - basic measurement sequence, 2-3
 - calculating data statistics, 2-26
 - calibrating the analyzer receiver to measure absolute power, 5-38
 - changing the sequence title, 2-58
 - clearing a sequencing from memory, 2-57
 - compensating for directional coupler response, 5-35
 - configuring a plot function, 4-8
 - configuring a print function, 4-3

constructing a loop structure in a sequence, 2-62
 coupling and uncoupling display markers, 2-14
 creating a sequence, 2-54
 creating flat limit lines, 2-37
 creating single point limits, 2-41
 creating sloping limit lines, 2-39
 defining line types, 4-14
 defining the plot, 4-12
 defining the print, 4-5
 deleting an instrument state, 4-41
 deleting a single instrument state file, 4-41
 deleting limiting segments, 2-42
 deviation from linear phase measurement, 2-32
 dividing measurement data by the memory trace, 2-7
 editing a sequence, 2-56
 editing limit segments, 2-42
 entering the power sensor calibration data, 5-34
 error-correction for full two-port measurements, 5-20
 error-correction for one-port reflection measurements, 5-17
 error-correction for TRL*, 5-23
 error-correction for TRM*, 5-23
 formatting a disk, 4-43
 frequency response error-corrections, 5-8
 gating in time domain, 2-70
 inserting a sequence command, 2-56
 limit testing using a sequence, 2-64
 loading a sequence from disk, 2-60
 making accurate measurements of electrically long devices, 5-48
 measuring devices using the time domain, 2-68
 measuring electrical length and phase distortion, 2-30
 measuring gain compression, 2-45
 measuring group delay, 2-33
 measuring magnitude and insertion phase response, 2-27
 measuring reflection response in time domain, 2-73
 measuring reverse isolation and gain, 2-49
 measuring swept harmonics, 2-66
 measuring transmission response in time domain, 2-68
 mixer group delay or phase, 3-24
 modifying a sequence command, 2-57
 modifying calibration standards, 5-26
 modifying TRL calibration standards, 5-28
 modifying TRMM calibration standards, 5-30
 offsetting limit lines, 2-44
 outputting a single page of values, 4-30
 outputting multiple plots to a single page using a printer, 4-25
 outputting plot files, 4-20
 outputting plot files from a PC to a plotter, 4-22
 outputting plot files from a PC to a printer, 4-23
 outputting single page plots using a printer, 4-24
 outputting the entire list of values, 4-31
 plotting a measurement to disk, 4-19
 plotting measurements in page quadrants, 4-28
 plotting multiple measurements on a full page, 4-26
 plotting multiple measurements per page, 4-17, 4-26
 plotting to an HPGL compatible printer, 4-18
 printing a sequence, 2-60
 printing multiple measurements per page, 4-7
 printing one measurement per page, 4-6, 4-16
 printing or plotting list values or operating parameters, 4-30
 purging a sequence from disk, 2-60
 ratioing measurements in channel 1 and 2, 2-7
 recalling a file, 4-42
 renaming an instrument state file, 4-42
 re-saving an instrument state, 4-41
 resetting plotting parameters to default values, 4-16
 resetting the printing parameters to default values, 4-6
 response and isolation error-correction for reflection measurements, 5-13
 response and isolation error-correction for transmission measurements, 5-15
 response error-correction for reflection measurements, 5-8
 response error-correction for transmission measurements, 5-10
 reviewing limit line segments, 2-43
 running a limit test, 2-43
 running a sequence, 2-55
 saving a data trace to the display memory, 2-6
 saving an instrument state, 4-35
 searching for a target amplitude, 2-24

- searching for bandwidth, 2-25
- searching for maximum amplitude, 2-22
- searching for minimum amplitude, 2-23
- sequencing, 3-17
- setting center frequency with markers, 2-18
- setting CW frequency using markers, 2-21
- setting display reference using markers, 2-20
- setting electrical delay using markers, 2-21
- setting frequency span with markers, 2-19
- setting measurement parameters, 2-3
- setting start frequency with markers, 2-17
- setting stop frequency with markers, 2-17
- setting the frequency range, 2-3
- setting the measurement type, 2-4
- setting the source power, 2-4
- setting up a color printer, 4-6
- solving problems with disk storage, 4-43
- stopping a sequence, 2-55
- storing a sequence on a disk, 2-59
- subtracting memory trace from measurement data trace, 2-7
- test sequencing, 2-53
- test with limit lines, 2-36
- titling the active channel display, 2-8
- titling the displayed measurement, 4-29
- tracking amplitude, 2-25
- using analyzer display markers, 2-9
- using continuous and discrete markers, 2-9
- using delta (Δ) markers, 2-11
- using **MKR ZERO** to activate a fixed reference marker, 2-13
- using polar format markers, 2-14
- using the tuned receiver mode, 2-51
- using the **Δ REF= Δ FIXED MKR** key to activate a fixed reference marker, 2-12
- viewing both measurement channels, 2-5
- viewing plot files on a PC, 4-20
- viewing the measurement data and memory trace, 2-6
- procedures
 - error-correcting measurements, 5-7
 - LO to RF isolation for mixers, 3-33
 - mixer conversion compression, 3-28
 - mixer RF feedthrough, 3-35
 - power meter calibration for mixer measurements, 3-6
- processing details, 6-5
- programming, 11-14
- programming-command to key-function cross reference, 9-48
- programming interface, 11-14

- programming specifications, 7-33
- programs
 - example, 11-6
- P? status notation, 1-8
- purging a sequence from disk, 2-60
- purpose and use of different error-correction procedures, 5-5

Q

- quadrants plotted, 4-28
- quarter page plots, 4-28

R

- rack mount cabinet, 11-4
- rack mount flange kit
 - with handles option, 1-12
 - without handles option, 1-12
- range
 - dynamic:how to increasing, 5-56
 - time domain, 6-130
- ratio calculations, 6-5
- ratio measurement in channel 1 and 2, 2-7
- raw data arrays, 6-6
- R channel and source calibration connections, 3-8
- R channel connector locations, 1-5
- R-Channel inputs, difference between internal and external, 3-4
- R-Channel power offset, 3-4
- real format, 6-34
- rear panel
 - features and connectors, 1-10
- rear panel connectors, 7-34
- recalling a file, 4-42
- receiver, 6-3
- receiver calibration, 5-11
 - connections, 3-14
- receiver calibration procedure, 5-38
- receiver configuration option, 1-12
- receiver crosstalk
 - reducing, 5-57
- receiver noise floor
 - reducing, 5-56
- reduce
 - averaging factor, 5-52
 - number of measurement points, 5-52
 - receiver noise floor, 5-56
- reducing
 - receiver crosstalk, 5-57
 - trace noise, 5-57
- reducing noise, 6-44
 - averaging, 6-44
 - IF bandwidth, 6-45
 - smoothing, 6-45
- reference

- (10 MHz) adjust, 1-11
- (10 MHz) output, 1-11
- level of display, 1-8
- markers, 2-11
- reference documents, 6-163
- reference plane
 - extending, 5-3
- reflection measurements
 - using bandpass mode, 6-119
 - using low pass mode, 6-123
- reflection response in time domain, 2-73
- reflection tracking
 - uncorrected specifications, 7-2
- register
 - contents, 4-33
- register data
 - retention, 4-33
- Re/Im MKR, 2-15, 2-16
- relative
 - marker mode, 2-11
- relative velocity factor
 - adjusting of, 6-119
- relative velocity for time domain, 2-75
- remote control, 11-14
- remote enable (REN) control line, 11-17
- remote/local capability (RL1), 11-18
- remote operation (R), 11-19
- remote programming specifications, 7-33
- renaming a file, 4-42
- REN (remote enable) control line, 11-17
- repeatability
 - connector, 5-2
- repetitive attenuator switching
 - allowing, 6-19
- re-save a file, 4-41
- reset
 - plotting parameters to default values, 4-16
 - printing parameters, 4-6
- resolution
 - time domain, 6-131
- response
 - calibration connections, 3-18, 3-34, 3-36
 - error-correction for reflection measurements, 5-8
 - error-correction for transmission measurements, 5-10
 - function block location, 1-4
- response and isolation calibration, 6-73
- response calibration, 6-73
- response function, 6-25-46
- restarting a calibration, 6-75
- results of measurement
 - saving, 4-36
- retention
 - of memory data, 4-33

- return to HP calibration agreement option, 1-13
- return to HP calibration option, 1-13
- return to HP full service agreement option, 1-13
- return to HP repair agreement option, 1-13
- reverse isolation and gain measurement, 2-49
- reviewing the limit line segments, 2-43
- RF
 - how defined for mixers, 3-2
- RF feedthrough, 3-35
- R+jX MKR, 2-16
- RL1 (complete remote/local capability), 11-18
- RPG knob, 6-10
- R (remote operation), 11-19
- RS-232 (serial) interface, 1-10
- rules for code naming, 11-21
- running
 - a limit test, 2-43
 - a sequence, 2-55
- S**
- sample-and-sweep correction mode, 5-36
- sample-and-sweep mode
 - for power meter calibration, 5-36
- sampler/IF correction, 6-5
- save a data trace to the display memory, 2-6
- (SAVE/RECALL)** menu map, 8-11
- saving
 - a file, 4-33
 - a user kit, 5-28
 - places where you can, 4-33
 - to a computer, 4-34
 - user kit to disk, 5-28
- saving measurement results including calibration, 4-36
- saving, printing, and plotting, 4-1
- scale, 6-7
- scale/div. area of display, 1-8
- SCALE PLOT**, 4-15
- scale reference menu, 6-38
- (SCALE REF)** menu map, 8-12
- searching for values with markers, 2-22
 - bandwidth, 2-25
 - maximum amplitude, 2-22
 - minimum amplitude, 2-23
 - target amplitude, 2-24
 - tracking amplitude, 2-25
- second portion of conversion compression measurement connections, 3-30
- segment
 - deleting, 2-42
- segment menu, 6-22
- selecting

- calibration kits, 6-75
- selecting line types, 4-14
- sensor calibration data, 5-34
- (SEQ)** menu map, 8-13
- sequence
 - creation, 2-54
 - size of, 6-139
 - using HP-IB, 6-144
- sequence of measurement, 2-3
- sequencing
 - autostarting, 6-139
 - cascading multiple sequences, 2-61
 - changing the sequence title, 2-58
 - clearing a sequence from memory, 2-57
 - command information, 6-138
 - concepts, 6-138-144
 - decision making functions, 6-142
 - deleting commands, 2-56
 - editing, 6-139
 - editing a sequence, 2-56
 - gosub sequence command, 6-140
 - HP-GL commands, 6-143
 - inserting a command, 2-56
 - limit test sequence, 2-64
 - loading a sequence from disk, 2-60
 - loop counter sequence, 2-62
 - menu, 6-140
 - modifying a command, 2-57
 - printing a sequence, 2-60
 - purging a sequence from disk, 2-60
 - reading using HP-IB, 6-144
 - running a test sequence, 2-55
 - special functions menu, 6-142
 - stopping a sequencing, 2-55
 - storing a sequence on a disk, 2-59
 - subprograms, 2-61
 - test procedure, 2-53
 - titles, 6-139
 - TTL input for decision making, 6-140
 - TTL I/O menu, 6-140
 - TTL out menu, 6-142
 - with loop counter, 6-139
- serial number plate location, 1-10
- serial (RS-232) interface, 1-10
- service and support options, 1-13
- service request asserted by the analyzer (S), 11-19
- service request (SRQ) control line, 11-17
- setting gate parameters, 2-70
- setting HP-IB addresses, 11-20
- setting measurement parameters using markers, 2-16
- sex of type-N calibration standard, 5-6
- SH1 (full-source handshake), 11-18
- shape of gate, 2-70
- shipment weight, 7-37
- shortened sweep time, 5-50
- signal flow in a mixer example, 3-33
- single bus concept, 11-19
- single page of values printed or plotted, 4-30
- single point limits, 2-41
- six gigahertz operation option, 1-12
- sloping limit lines, 2-39
- smith chart
 - format, 6-31
- Smith chart markers, 2-15
 - G+jB MKR, 2-16
 - LIN MKR, 2-16
 - LOG MKR, 2-16
 - Re/Im MKR, 2-16
 - R+jX MKR, 2-16
- Smith or polar format markers, 2-12
- smoothing, 6-7, 6-45
- Smo status notation, 1-8
- softkey
 - label location, 1-9
 - labels of display, 1-9
 - location, 1-4
- softkey definitions, 9-2
- softkey locations, 9-69
- softkey menu maps, 8-1
- softkeys and corresponding front panel access key, 9-69
- software
 - sample, 11-6
- solutions
 - for printing or plotting problems, 4-32
- solving
 - disk storage problems, 4-43
- source, 6-2
- source attenuator
 - switch protection, 6-19
- source match, 6-52
 - uncorrected specifications, 7-2
- span
 - frequency:decrease, 5-50
- span setting for gating, 2-70
- S-parameters, 6-26
- specifications, 7-1
 - 3.5 mm test ports, 7-8
 - 50 Ω type-N test ports, 7-5
 - 75 Ω type-F test ports, 7-14
 - 75 Ω type-N test ports, 7-11
 - 7 mm test port, 7-2
 - dynamic range, 7-1
 - error-corrected, 7-2
 - external source mode, 7-29
 - frequency characteristics, 7-27
 - frequency offset, 7-29
 - group delay, 7-31

- harmonics (option 002), 7-28
- impedance, 7-28
- magnitude, 7-29
- measurement port, 7-2
- noise level, 7-28
- option 001, 7-34
- output power, 7-27
- phase, 7-29, 7-31
- remote programming, 7-33
- spectral purity characteristics, 7-27
- spurious signals, 7-27
- type-N test ports, 7-4
- uncorrected, 7-2
- uncorrected test port, 7-2
- specify
 - class menu, 6-81
 - offset menus, 6-80
- spectral purity characteristics, 7-27
- spectrum of RF, LO and IF signals present in
 - a conversion loss measurement, 3-7
- speed increased, 5-50
- split display, 2-5
- spurious signals
 - specifications, 7-27
- SR1 (complete service request capabilities), 11-18
- SRQ (service request) control line, 11-17
- S (service request asserted by the analyzer), 11-19
- standard connections for
 - full two port error-correction, 5-20
 - one port reflection error-correction, 5-18
 - receiver calibration, 5-11
 - response and isolation error-correction for reflection measurements, 5-14
 - response and isolation error-correction for transmission measurements, 5-16
 - response error-correction for reflection measurement, 5-9
 - response error-correction for transmission measurements, 5-10
- standard definitions
 - entering, 5-26
 - examining, 5-26
 - modifying, 5-26
- standards
 - calibration, 5-6
 - defining menus, 6-78
- standard system maintenance service option, 1-13
- start frequency set with markers, 2-17
- starting
 - a plot, 4-16
 - a print, 4-6
- start values possible, 1-6
- statistics calculation, 2-26
- status indicators, 11-19
 - HP-IB, 6-104
- * status notation, 1-8
- status notations, 1-7
- step attenuator, 6-2
 - switch protection, 6-19
- step keys, 6-10
- steps of making a measurement, 2-3
- stimulus
 - function block, 1-4
 - state, 5-5
- stimulus function, 6-11-24
- stimulus menu, 6-12
- stop frequency
 - setting with markers, 2-17
- stopping
 - a print or plot, 4-30
 - a sequencing, 2-55
- stop values possible, 1-7
- storage
 - locations, 4-33
 - mediums, 4-33
- storage conditions, 7-36
- storing
 - a sequence on a disk, 2-59
 - to external disk, 11-5
 - to internal disk, 11-5
 - to internal memory, 11-5
- storing data
 - methods of, 12-1
- structure of HP-IB bus, 11-16
- subtract memory trace from the measurement data trace, 2-7
- support and service options, 1-13
- sweep
 - definition of, 6-5
 - how to set auto sweep time, 5-51
 - how to set chop sweep, 5-54
- sweep modes
 - alternate, 6-23, 6-100
 - chop, 6-23, 6-100
- sweep speed
 - increase, 5-50
 - increasing, 5-50
- sweep time
 - auto, 6-16
 - manual, 6-16
 - minimum, 6-16
- sweep type
 - how to set, 5-53
- sweep types, 6-21
 - CW time, 6-23
 - linear, 6-21
 - list frequency, 6-22

- logarithmic, 6-22
- power, 6-23
- swept harmonics measurement, 2-66
- swept IF conversion loss measurement
 - example, 3-16
- swept power conversion compression
 - measurement example, 3-32
- swept RF/IF mixer measurement, 3-7
- switch
 - protection, 6-19
- SWR format, 6-33
- syntax for commands, 11-21
- synthesized source, 6-2
- system
 - cabinet, 11-4
 - characterization, 5-7
 - controller mode, 6-104
 - menu, 6-106
 - overview, 6-2-3
 - testmobile, 11-4
- system accessories, 11-4
- systematic errors, 5-4
 - characterizing, 6-53
- system bandwidth
 - how to change, 5-56
 - how to widen, 5-52
- system controller capabilities (C1,C2,C3), 11-18
- system-controller mode, 11-19, 11-20
- SYSTEM** key, 6-109
- SYSTEM** menu map, 8-15

T

- T6 (basic talker), 11-18
- talker interface function, 11-15
- talker/listener
 - mode, 6-104
- talker/listener mode, 11-20
- talk mode (T), 11-19
- target amplitude search, 2-24
- TE0 (no extended talker capabilities), 11-18
- techniques
 - optimizing measurements, 4-43
- temperature conditions, 7-36
- temperature drift, 5-2
- test fixtures
 - transistors, 11-3
- testing with limit lines, 2-36
- testmobile, 11-4
- test port
 - specifications:50Ω, 7-2
 - specifications:7 mm, 7-2
- test port bias input (BIAS CONNECT), 7-35
- test port coupling, 6-15
- test port dimensions, 7-33

- test port power
 - increasing, 5-56
- test ports
 - 3.5 mm test port specifications, 7-8
 - 50Ω type-N test port specifications, 7-5
 - 75Ω type-F test port specifications, 7-14
 - 75Ω type-N test port specifications, 7-11
- test sequence
 - size of, 6-139
 - using HP-IB, 6-144
- test sequence connector location, 1-11
- test sequence output (TEST SEQ), 7-35
- test sequencing
 - autostarting, 6-139
 - cascading multiple sequences, 2-61
 - changing the sequence title, 2-58
 - clearing a sequence from memory, 2-57
 - command information, 6-138
 - concepts, 6-138-144
 - decision making functions, 6-142
 - deleting commands, 2-56
 - editing, 6-139
 - editing a sequence, 2-56
 - gosub sequence command, 6-140
 - GPIO, 6-139
 - HP-GL commands, 6-143
 - inserting a command, 2-56
 - limit test sequence, 2-64
 - loading a sequence from disk, 2-60
 - loop counter sequence, 2-62
 - menu, 6-140
 - modifying a command, 2-57
 - printing a sequence, 2-60
 - procedures, 2-53
 - purging a sequence from disk, 2-60
 - reading using HP-IB, 6-144
 - running a sequence, 2-55
 - special functions menu, 6-142
 - stopping a sequence, 2-55
 - storing a sequence on a disk, 2-59
 - subprograms, 2-61
 - titles, 6-139
 - TTL I/O menu, 6-140
 - TTL out menu, 6-142
 - with loop counter, 6-139
- test set, 6-3
 - hold mode, 6-19
 - interconnect location, 1-11
- test set switch, controlling the, 5-54
- test using limits, 2-43
- time domain
 - bandpass, 6-119
 - bandpass mode, 6-117
 - bandpass mode:reflection, 6-119
 - bandpass mode:transmission, 6-121

- concepts, 6-117–137
- forward transform mode, 6-118
- gating, 6-133
- gating procedure, 2-70
- general theory, 6-118
- low pass, 6-122
- low pass impulse mode, 6-117
- low pass mode, fault location
 - measurements, 6-123
- low pass mode, reflection, 6-123
- low pass mode, transmission, 6-125
- low pass, setting frequency range, 6-122
- low pass step mode, 6-117
- masking, 6-127
- measurements, 2-68
- option, 1-12
- range, 6-130
- reflection response, 2-73
- relative velocity factor, 6-119
- resolution, 6-131
- transform, 6-6
- transmission response measurement, 2-68
- velocity factor, 2-75
- windowing, 6-128
- time domain range
 - defining, 6-11
- time for measurements, 7-33
- time stamp, 4-30, 11-13
- time-to-frequency domain, 6-118
- title
 - area of display, 1-8
 - of sequence, 2-58
 - the active channel display, 2-8
- titling
 - the displayed measurement, 4-29
- to use fast 2-port calibration, 5-54
- trace
 - dual, 6-8
- trace math, 2-7
 - divide measurement data by the memory
 - trace, 2-7
- trace math operation, 6-6
- trace noise
 - reducing, 5-57
- trace viewing, 2-6
- tracking, 6-53
 - an amplitude, 2-25
- transfer formats, 7-33
- transfer of data, 11-16
- transform, 6-6
 - CW time-to-frequency domain, 6-134
 - frequency-to-time domain, 6-117
 - time-to-frequency domain, 6-118
- transform measurements
 - forward, 6-135
 - transform menu, 6-117
 - transform modes
 - time domain bandpass, 6-117
 - time domain low pass impulse, 6-117
 - time domain low pass step, 6-117
 - transistor test fixtures, 11-3
 - transmission measurements
 - using bandpass mode, 6-121
 - using low pass mode, 6-125
 - transmission response in time domain, 2-68
 - transmission tracking
 - uncorrected specifications, 7-2
 - trigger menu, 6-18
 - tri-state drivers (E2), 11-18
 - TRL calibration, 2-76
 - TRL* error-correction, 5-23
 - TRL*/LRM* calibration, 6-85
 - error model, 6-86
 - fabricating and defining standards, 6-91
 - how it works, 6-86
 - improving raw load match, 6-88
 - improving raw source match, 6-88
 - isolation, 6-87
 - load match, 6-88
 - options, 6-93
 - procedure, 6-90
 - reason for using, 6-85
 - requirements for standards, 6-90
 - source match, 6-88
 - terminology, 6-85
 - TRL*/LRM* two-port calibration, 6-74
 - TRL standard modification, 5-28
 - TRM* error-correction, 5-24
 - TRM standard modification, 5-30
 - trouble
 - solving for printing or plotting, 4-32
 - with disk storage, 4-43
 - tsH annotation, 6-19
 - tsH status notation, 1-8
 - T (talk mode), 11-19
 - TTL I/O, 6-140
 - tuned receiver mode, 3-17, 6-111
 - compatible sweep types, 2-51
 - description, 2-51
 - external source requirements, 2-52
 - making measurements, 2-51
 - mixer testing, 6-149
 - test setup, 2-51
 - type-F (75Ω) test ports
 - measurement uncertainties, 7-14, 7-17, 7-20, 7-23
 - type-F test ports
 - specifications, 7-14
 - type-N (50Ω) test ports
 - specifications, 7-5

- type-N (75Ω) test ports
 - measurement uncertainties, 7-11
 - specifications, 7-11
- type-N calibration standard sex, 5-6
- type-N test ports
 - specifications, 7-4
- type-N test ports (50Ω)
 - measurement uncertainties, 7-5
- type of sweep
 - how to set, 5-53
- typical calibration kit standard and corresponding number, 5-27

U

- $\Delta\text{REF}=\Delta\text{FIXED MKR}$, 2-12
- uncertainties
 - 3.5 mm test port measurements, 7-8
 - 50Ω type-N test port measurements, 7-5
 - 75Ω type-F test ports, 7-14, 7-17, 7-20, 7-23
 - 75Ω type-N test ports, 7-11
 - 7 mm test port measurements, 7-2
- understanding S-parameters, 6-26
- units, 11-23
- units terminator, 6-9
- \uparrow status notation, 1-8
- up converter port connections, 3-3
- user kit
 - modified, 5-28
 - modifying, 5-28

- saving, 5-28
- user kit saved
 - to disk, 5-28
- using
 - AmiPro, 4-21
 - Freelance, 4-22

V

- valid characters, 11-22
- values
 - list, 4-30
- vector error-correction, 6-6
- velocity factor for time domain measurements, 2-75
- verification kit, 11-2
- verifying performance of calibration, 6-84
- video output (EXT MON), 7-35
- viewing
 - both channels with a split display, 2-5
 - both measurement channels, 2-5
 - plot files on a PC, 4-20
 - the measurement data and memory trace, 2-6
- volatile memory, 12-1
- voltage selector switch, 1-10

W

- weight, 7-37
- widen system bandwidth, 5-52
- windowing
 - time domain, 6-128